

HEADQUARTERS FOR SERVICE DATA



IN CANADA 30¢

JULY, 25¢

RADIO NEWS

AND

SHORT WAVE RADIO

TELEVISION

for the HOME

NOW ASSURED

SEE PAGE 4

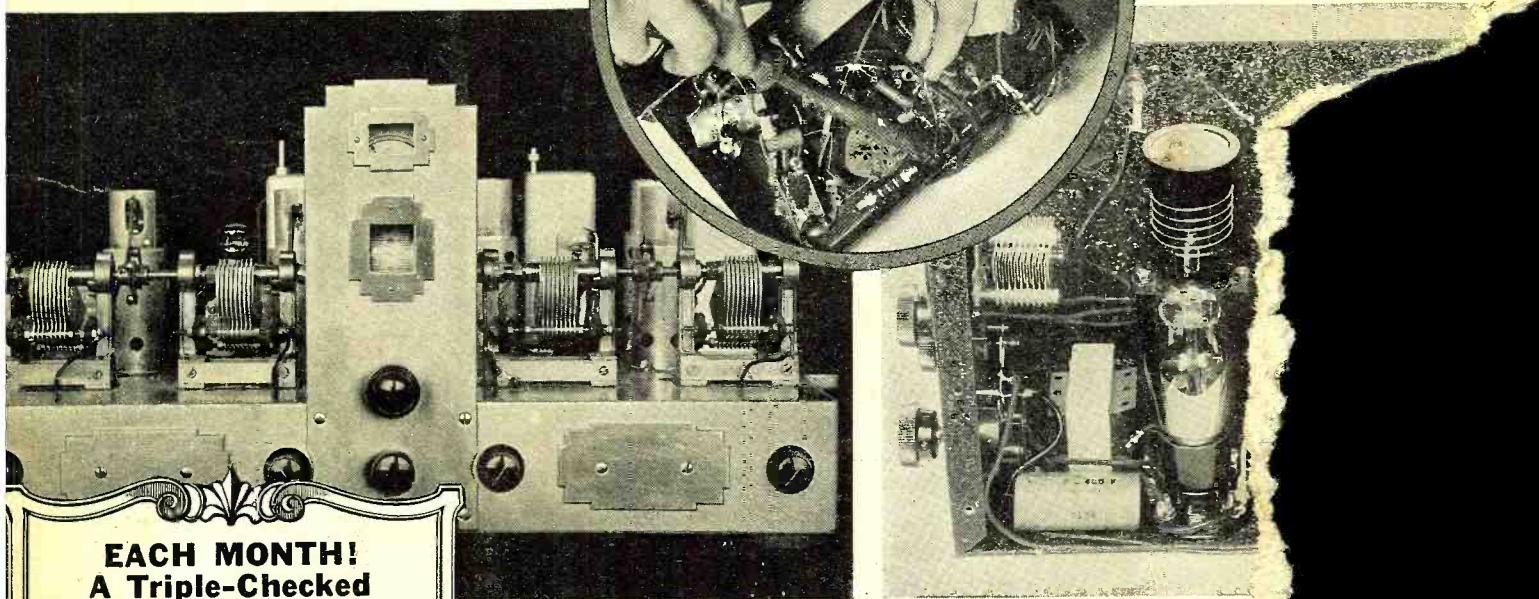
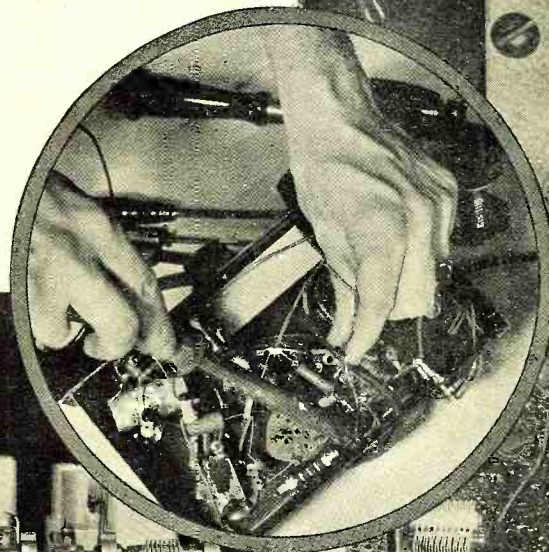

EACH MONTH! A Triple-Checked S. W. Time-Table

Three sources triple-check the RADIO NEWS SHORT-WAVE TIME-TABLE:

1. Monthly logs of 350 Official R. N. Listening Posts in 45 strategic countries for world-wide S.W. reception.
2. Daily logs by experts in our Westchester Listening Post.
3. Monthly Official Schedules from the World's Leading S.W. Stations.

TELEVISION ADVANCE

A Publication Devoted to Progress

Service Work
Engineering
Experiments
Measurements

Set Building
Short Waves
DX Reception
Amateur Activity

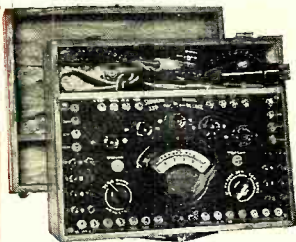

SUPREME 339—DE LUXE ANALYZER

A super-analyzer with direct resistance ranges up to 20 Megs, with self-contained power supply and many other features . . . \$39.95

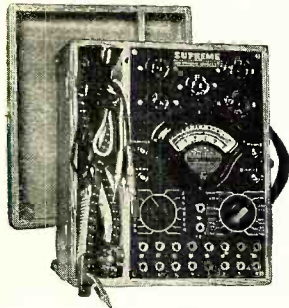

SUPREME 339—STANDARD ANALYZER

A new Free Reference Point Analyzer—the most outstanding value in the low price field . . . \$29.95

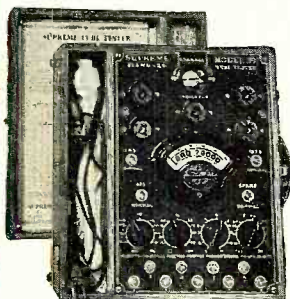

SUPREME 89—STANDARD TUBE TESTER

A new low priced Tube Tester, featuring Supreme's famous Neonized tube test . . . \$34.95



385—AUTOMATIC ANALYZER
A new instrument, combining the features of the Supreme 339—DeLuxe Analyzer and the Supreme 89—DeLuxe Tube Tester, plus many other features possible in a portable instrument. Supreme's exclusive design . . . \$77.95



339—SIGNAL GENERATOR
A new instrument, specially designed for use with film equipment and other systems. . . \$69.95

339—SIGNAL GENERATOR
A new instrument, specially designed for use with film equipment and other systems. . . \$36.95

HERE THEY COME!

The Most **SENSATIONAL** instruments in radio—

In last month's magazines Supreme promised instruments of the most startling design for service, speed and precision. Instruments offering many new features, in addition to new all-metal tube testing. We present them to you through your jobber's show rooms, confident that you will find our promises more than fulfilled.

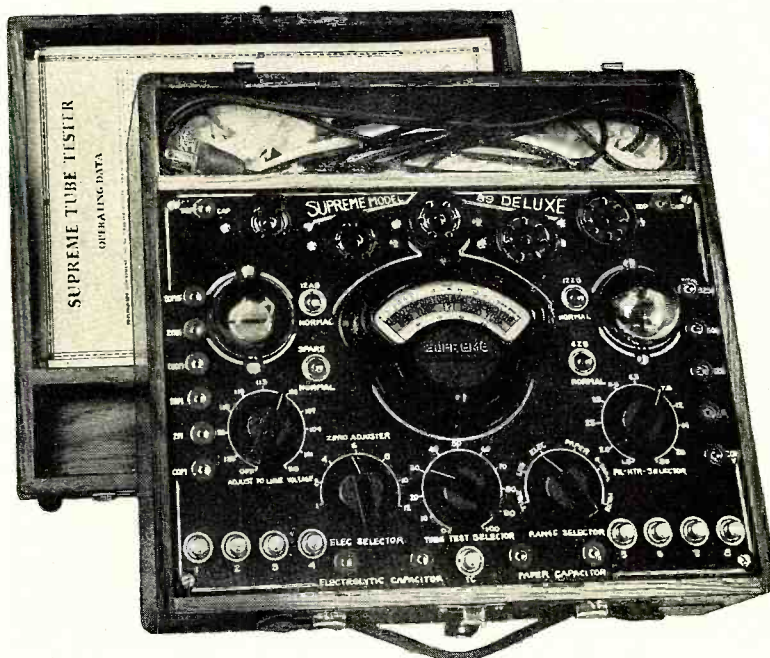

Supreme 89—DeLuxe Tube Tester, \$45.95

Dealers Net Cash Wholesale Price

An outstanding example of Supreme engineering ingenuity. Listen to these features: A general utility tester; a tube tester with English reading scale, testing all tubes including new all metal 8 prongs; Neon tube leakage tester; Neon condenser tester; Electrolytic condenser tester with English reading scale. 4 range volt meter for point-to-point testing; 3 range Ohmmeter and 2 range Megohmmeter. Resistance ranges to 20 Megohms are with self contained power supply.

Wide awake, professional radio-men won't wait a day to enjoy the pride of possession and servicing superiority of the ultra modern Supreme 89-DeLuxe.

Turns Instruments Inside Out

For the first time the service-man can know exactly what he is getting in an instrument before he buys. Send the coupon for the free

Supreme Technical Manual of the Instrument or instruments of your choice. Written by engineers who have done the service-man's work and speak his language, these manuals virtually turn the instrument inside out and through clear, service-man's English and simple illustrations explain every circuit. Instead of advertising catch phrases and sales ballyhoo we are giving you the real dope. Send the coupon now, no obligation.



SUPREME INSTRUMENTS CORP.,
Supreme Bldg., Greenwood, Miss.

Send me the complete illustrated Technical Manual on Instruments checked below:

- Supreme 89—DeLuxe Tube Tester
- Supreme 89—Standard Tube Tester
- Supreme 385—Automatic
- Supreme 189—Signal Generator
- Supreme 339—Deluxe Analyzer
- Supreme 339—Standard Analyzer
- Supreme 391—P. A. Analyzer

530

Name _____
Address _____
Town _____ State _____
Jobber Preference _____

RADIO NEWS INDEX

(Departments not included)

VOLUME XVI

January, 1935

NUMBER 7 PAGE

The Future of Short Waves.....	Leading Authorities.....	400
Television and Facsimile in 1935.....	Television Experts.....	402
The "Skyscraper" Universal Power Pack.....	D. Pollack and S. G. Taylor.....	403
First Aid to Inventors (Part Three).....	E. E. Free.....	404
World Distance Map (Australia).....	John M. Borst.....	413
A Skip-Band "Superhet".....	Robert Hertzberg.....	416
Education for "Making a Living in Radio" (Part Two).....	Zeh Bouck.....	418
Short-Wave Marine Radio.....	Frederick Siemens.....	420
An "Acorn" Tube.....	A. Fenderson.....	422
Radio in Aircraft (Part Two).....	Henry W. Roberts.....	422
Ohmmeter Design (Part One).....	Alfred R. Gray.....	424

VOLUME XVI

February, 1935

NUMBER 8

How to Build a Simple Electronic Alarm.....	John D. Reid.....	466
The New Pries Television Scanner.....	Elmore B. Lyford.....	467
Broadcast Stations in the U. S.....	John M. Borst.....	474
Verifying DX Reception.....	Robert Hertzberg.....	476
Sunset to Sunrise with Foreign DX (Part One).....	R. H. Tomlinson.....	477
Variable I.F. Coupling.....	A. A. Webster.....	479
Ohmmeter Design (Part Two).....	Alfred R. Gray.....	480
An All-Wave Signal Generator (No. 4 in the Series).....	John H. Potts.....	482
Choosing Sensitivity and Volume Controls.....	L. A. de Rosa.....	484
First Aid to Inventors (Part Four).....	E. E. Free.....	485
Radio in Aircraft (Part Four).....	Henry W. Roberts.....	487
A New Rack-and-Panel Amplifier (Kenyon—Part One).....	B. J. Montyn.....	488
Building a Slide-Wire Bridge.....	Gerard J. Kelley.....	489
Tests on 16-Tube "Super" (Midwest).....	By the Staff.....	501
Making Plans for a Short-Wave Converter.....	S. Gordon Taylor.....	502

VOLUME XVI

March, 1935

NUMBER 9

Home-Built "High-Fidelity" Receiver.....	John M. Borst.....	536
How to Build the Browning '35 (Part One).....	Glenn H. Browning.....	538
Designing Saturable Reactors.....	Myron J. Brown.....	540
The "All-Star" Junior All-Wave Receiver.....	Lawrence M. Cockaday.....	542
Experiments with Multiple Regeneration.....	J. Plebanski.....	544
13-550 Meter Superheterodyne Receiver (Scott XV).....	S. Gordon Taylor.....	547
Short-Wave Converter Design.....	S. Gordon Taylor.....	549
Improving Your Regenerative Receiver.....	Robert Hertzberg.....	549
A New Rack-and-Panel Amplifier (Kenyon—Part Two).....	B. J. Montyn.....	557
First Aid to Inventors (Part Five).....	E. E. Free.....	558
An All-Wave Signal Generator (Part Two).....	John H. Potts.....	560
Radio in Aircraft (Part Four).....	Henry W. Roberts.....	562
Sunset to Sunrise with Foreign DX (Part Two).....	R. H. Tomlinson.....	563

VOLUME XVI

April, 1935

NUMBER 10

The Future of Short-Wave Reception (Part One).....	Charles A. Morrison.....	598
The "Radio News" S. W. Converter (Part One).....	S. Gordon Taylor.....	600
A Modern "Ham" Receiver (Super Skyrider).....	By the Staff.....	603
How to Build the Browning '35 (Part Two).....	Glenn H. Browning.....	604
Single-Tube A.C.-D.C. Receiver.....	Richard Feeney.....	606
S. W. Station Identification Chart.....	By the Staff.....	607
Wavelength-Frequency Conversion Chart.....	By the Staff.....	613
World Distance Map (South Africa).....	John M. Borst.....	614
Testing the "All-Star" Junior.....	By the Editor.....	615
A New Double-Doublet Antenna.....	By the Staff.....	615
How I Won the Denton Trophy.....	H. S. Bradley.....	616
World Time Conversion Chart.....	The Technical Editor.....	617
Short-Wave Design Calculations.....	Ralph E. Batchelor.....	618
High-Fidelity (Adjustable).....	I. A. Mitchell.....	621
First Aid to Inventors (Part Six).....	E. E. Free.....	622
U. S. Radio Time Signals.....	Robert Hertzberg.....	627
A New 4-Band Superheterodyne (General Electric Mod. 81).....	By the Staff.....	627
Profits in Group Hearing Aids.....	Charles A. and Paul Bottomly.....	628

VOLUME XVI

May, 1935

NUMBER 11

1935-1936 Automobile Radios.....	Robert Hertzberg and W. C. Dorf.....	662
High-Range V. T. Voltmeter.....	William R. Harry.....	664
High-Fidelity Pre-Amplifier.....	S. Rutenberg.....	667
Tests of Modern "Ham" Receiver (Super Skyrider).....	By the Staff.....	668
The Acorn Tube on 3/4 Meter (Part One).....	Ed Glaser.....	669
Using the Cathode-Ray Oscillograph (Part One).....	Kendall Clough.....	670
Combination Service Meter.....	L. R. Goetz.....	671
Calculating Power Output of Tubes.....	C. A. Johnson.....	672
Radio in Aircraft (Part Five).....	Henry W. Roberts.....	673
The Future of S.W. Reception (Part Two).....	Charles A. Morrison.....	674
The Radio News S.W. Converter (Part Two).....	S. Gordon Taylor.....	675
U. S. and World Mileage Chart.....	John M. Borst.....	677
World Alphabets.....	C. C. Clark, Ph.D.....	683
How to Build the Browning '35 (Part Three).....	Glenn H. Browning.....	684
S. W. Station Identification Chart (Part Two).....	By the Staff.....	687
Build a Remote Control Tuner.....	Richard F. Shea.....	691
Broadcast Stations in N. and S. Americas.....	By the Staff.....	692

VOLUME XVI

June, 1935

NUMBER 12

New Receivers for Summer Radio.....	W. C. Dorf and R. Hertzberg.....	726
British Television.....	Samuel Kaufman.....	728
The New Metal Tubes.....	John M. Borst.....	729
Tri-Band Short-Wave Receiver.....	Harry D. Hooton.....	730
The Acorn Tube on 3/4 Meter (Part Two).....	Ed Glaser.....	733
Design of Crystal Band Filters (Part One).....	W. W. Waltz.....	734
New D.C. Photocell Amplifier.....	By the Staff.....	736
Home Built A.C. Pre-Amplifier.....	Walter Widar.....	737
Voltage-Divider Calculations.....	Walther Richter.....	738
All-Purpose Service Tester.....	Floyd Fausett.....	739
Calculating Power Output of Tubes (Part Two).....	C. A. Johnson.....	740
The Oscillator in Servicing.....	O. J. Morelock Jr.....	741
"Perpetual" Tube Checker (Part One).....	Verne V. Gumsolley.....	742
Using the Cathode-Ray Oscillograph (Part Two).....	Kendall Clough.....	744
The Future of S.W. Reception (Part Three).....	Charles A. Morrison.....	745
World Distance Map (South America).....	John M. Borst.....	751
The Radio News S.W. Converter (Part Three).....	S. Gordon Taylor.....	753
Testing the Browning '35.....	By the Editor.....	754
Station List—Europe (Broadcast Band).....	By the Staff.....	755



July, 1935

Edited by LAURENCE M. COCKADAY

S. GORDON TAYLOR
Managing Editor

WILLIAM C. DORF
Associate Tech. Editor

JOHN M. BORST
Technical Editor

SAMUEL KAUFMAN
Broadcast Editor

EVERETT M. WALKER
Associate Editor

JOSEPH F. ODENBACH
Art Editor

Reading Guide to this Issue—

As a matter of convenience for those having specialized interests in the radio field, the following lists the articles and features in this issue, classified under 14 heads. The numbers correspond with the article numbers in the Table of Contents on this page:

- Amateurs—1, 3, 8, 11, 12, 14, 15, 16, 17, 18, 22, 23, 24, 25, 27, 32, 35.
- Broadcast Fans—1, 3, 5, 13, 17, 19, 20, 21, 29, 30, 33, 35.
- Dealers—1, 2, 3, 4, 13, 15, 16, 17, 19, 20, 21, 28, 31, 33, 35.
- Designers—1, 3, 5, 8, 18, 24, 27, 33, 35, 37.
- DX Fans—1, 4, 5, 13, 17, 19, 29, 33, 35.
- Engineers—1, 3, 5, 6, 7, 8, 27, 33, 35, 37.
- Experimenters—1, 3, 4, 5, 6, 7, 8, 9, 10, 11, 12, 13, 17, 18, 20, 21, 22, 23, 24, 25, 26, 27, 29, 32, 33, 35, 36, 37.
- Manufacturers—1, 2, 3, 7, 21, 34, 37.
- Operators—1, 22, 23, 24, 25, 34, 35.
- Servicemen—1, 2, 3, 8, 10, 13, 17, 18, 19, 20, 21, 25, 26, 27, 28, 31, 32, 34, 35, 36, 37.
- Set Builders—1, 3, 4, 5, 8, 9, 10, 11, 12, 13, 24, 25, 26, 27, 32, 34, 35, 36, 37.
- S. W. Fans—1, 3, 4, 9, 11, 12, 14, 15, 16, 17, 18, 19, 21, 22, 23, 24, 34, 35.
- Students—1, 3, 4, 6, 7, 9, 10, 13, 21, 23, 24, 25, 26, 27, 28, 31, 32, 34, 35, 36, 37.
- Technicians—1, 3, 5, 8, 10, 11, 12, 13, 17, 18, 20, 24, 25, 26, 27, 28, 31, 32, 34, 35, 36, 37.

Next Month—

In the opinion of the editors the Potts Vacuum-Tube Micro-voltmeter represents the most important development ever offered to the serviceman or laboratory. John H. Potts has been working on this new instrument for several months in the RADIO NEWS Laboratory and has now progressed to a point which practically assures running a descriptive article in the August issue. One of the numerous outstanding applications of this device is in actually measuring the output of any service oscillator, showing the exact value of the signal being fed into a receiver under test.

1	RADIO NEWS Index (July to December, 1934).....	1
2	Dots and Dashes.....	3
3	Television—To the Front!.....	<i>Editorial</i> 4
4	Build a Set! Learn Radio.....	<i>Editorial</i> 5
5	Superhet De Luxe (Part 2).....	<i>B. Valentine</i> 6
6	Music from Whirling Disks.....	<i>Samuel Kaufman</i> 8
7	Television in Germany.....	<i>Wilhelm E. Schrage</i> 9
8	How to Make a Pantograph.....	<i>Sylvester Bruzas</i> 10
9	RADIO NEWS Symbol Chart.....	11
10	Building a Midget Radio.....	<i>George Day</i> 12
11	New S.W. Portable.....	14
12	Three-Tube S.W. Set.....	14
13	The R. N. Tenatuner.....	{ <i>S. Gordon Taylor</i> } 15 { <i>John H. Potts</i> }
14	The DX Corner for Short Waves.....	<i>L. M. Cockaday</i> 16
15	World Short-Wave Time-Table.....	18
16	World Short-Wave Station List.....	<i>John M. Borst</i> 22
17	Tests of Noise-Reducing Antenna.....	25
18	Capt. Hall's S.W. Page.....	<i>Capt. H. L. Hall</i> 26
19	Tests of Five-Tube Three-Band Receiver.....	<i>Victor Hall</i> 26
20	Making Home Talkies.....	<i>John Strong</i> 27
21	The Future of S.W. Reception (Part 4).....	<i>C. A. Morrison</i> 27
22	The "Ham" Shack.....	<i>Everett M. Walker</i> 28
23	Code Guild Schedule.....	29
24	The Acorn Tube on 3/4 Meter (Part 3).....	<i>Ed. Glaser</i> 30
25	Making a Living in Radio (Part 3).....	<i>Zeh Bouck</i> 32
26	"Perpetual" Tube-Checker (Part 2).....	<i>Verne V. Gunsolley</i> 34
27	Cathode Ray Oscillograph (Part 3).....	<i>Kendall Clough</i> 35
28	Service Tester (Part 2).....	<i>Floyd Fausett</i> 36
29	The DX Corner for the Broadcast Band.....	<i>S. Gordon Taylor</i> 37
30	Backstage in Broadcasting.....	<i>Samuel Kaufman</i> 40
31	The Service Bench.....	<i>Zeh Bouck</i> 42
32	Radio Physics Course.....	<i>Alfred A. Ghirardi</i> 44
33	What's New in Radio.....	<i>Wm. C. Dorf</i> 46
34	QRD?.....	<i>By G. Y.</i> 48
35	The Technical Review.....	<i>Robert Hertzberg</i> 50
36	The Oscillator in Servicing (Part 2).....	<i>O. J. Morelock, Jr.</i> 52
37	Design of Crystal Band Filters (Part 2).....	<i>W. W. Waltz</i> 56

Published Monthly by Teck Publications, Inc., Washington and South Avenues, Dunellen, N. J.

Lee Ellmaker
President and Treas.

B. Holcepl
Secretary

H. D. Crippen W. P. Jeffery
Advertising Management

Virgil Malcher
205 W. Wacker Dr., Chicago
Western Representative

EDITORIAL AND EXECUTIVE OFFICES
461 EIGHTH AVENUE, NEW YORK CITY, N. Y.

Entered as second class matter at the Post Office at Dunellen, N. J. under the act of March 3, 1879. Copyright, 1935, by Teck Publications, Inc., in U. S. and Canada. All rights reserved. Registration of title of this publication as a trade mark applied for in United States Patent Office. Printed in the United States of America. The contents of this magazine must not be reproduced without permission. We cannot be responsible for lost manuscripts, although every care is taken for their safety.

25c a Copy, \$2.50 a year,
\$3.00 in Canada, \$3.50 in
Foreign Countries. Sub-
scribers are notified that
change of address must reach
us five weeks in advance of
the next date of issue.

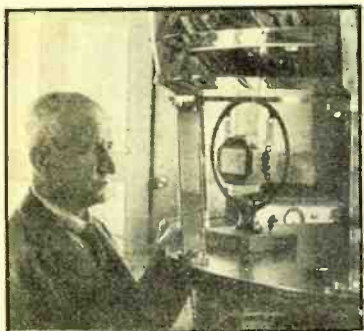

SPEAKS TO HIS MOTHER

Claude Cooper, lighthouse engineer of the Cape Point Lighthouse of South Africa, spoke directly to his mother, aged 80, in London, by short waves.

To Broadcast Normandie's Maiden Voyage

PARIS, FRANCE.—It is planned to let radio listeners "travel by proxy" on the maiden trip of the new French liner *Normandie*, prior to its arrival in New York on June 3rd. Broadcasts of the trip will be sent from the ship, by radio, and will be picked up and placed on the large broadcasting chains in America. The broadcasts will start with the sailing of the ship from Le Havre and end with its arrival in New York.

How Many Radio Sets in the World?

GENEVA, SWITZERLAND.—According to an annual chart issue by the International Broadcasting Office, here, there are now 48,300,000 radio receiving sets in use up to the beginning of this year. Forty percent are in the United States, with Great Britain second and Germany third, with 6,780,000 and 6,143,000 sets, respectively.

Perfects New Modulation System

NEW YORK, N. Y.—A new system in radio communication which is said to reduce interference and static by using "frequency modulation" instead of amplitude modulation was recently announced by Major Edwin H. Armstrong. Major Armstrong believes his invention also will help solve the problems of network television. In this new system, instead of changing the amplitude or strength of the incoming signal as is now the practice, the wavelength or frequency is altered according to variations in the voice or music. For some time this system has been subject to

RADIO IN THE "HOLD"

This is the Electronic control apparatus and relays installed in the hold of the model ship.

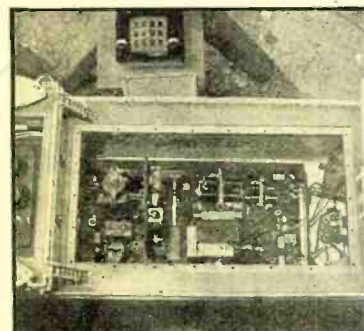

RADIO IN THE AIR

Records were broken for speed when this radio-controlled plane flew from Los Angeles to New York. Hal Smead, radio expert, D. A. Tomlinson, in command and Pete Redpath, navigation expert, shown left-to-right, upon alighting. The center illustration pictures the members of the Wireless Institute of Australia with their amateur constructed short-wave sets that they use in their aviation experiments for duplex plane-radio communication.

DOTS
and
DASHES

Short but Interesting Items from the Month's Radio News the World Over

experiment and tests by the NBC experimental station in the Empire State Building in New York City.

Television in America

CAMDEN, N. J.—Television soon is to be taken out of the laboratory here in America, for tests in the field, according to David Sarnoff, President of the Radio Corporation of America. He expects to make the first installation on the Empire State Building and twelve to fifteen months will be necessary to develop the plans and make the installations. He says that while television promises to supplement the present service of broadcasting by adding sight to sound, it will neither supplant nor diminish the importance and usefulness of sound broadcasting.

Radio Breaks American Plane Record

LOS ANGELES, CAL.—Radio control, an automatic pilot, and other electronic

HIS SHIP COMES IN

Felix LaVallee, a farmer living in Minnesota, built this radio controlled steamboat which he operates back and forth on a lake near his farm. He gained his knowledge of the technique from reading radio magazines.

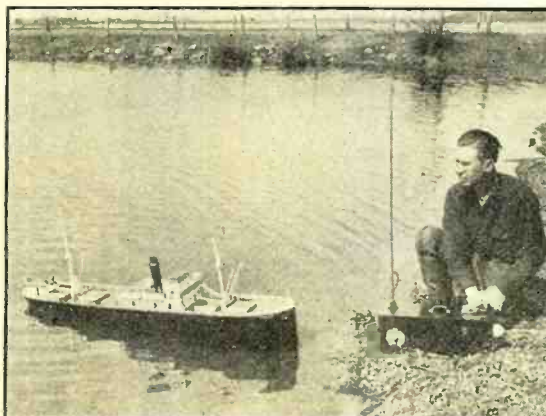

devices installed on a TWA "mystery" plane, here, recently served to lower the record from Los Angeles to New York to 11 hours 5 minutes. Harold Snead, radio beam expert, watched the apparatus while it piloted the craft safely and more speedily over most of the 2,400 miles' journey faster than any human pilot has done before. D. W. Tomlinson, the actual appointed pilot of the plane touched the controls only three times, once in taking off, once in crossing the San Bernardino range; and again in landing.

A New Stratosphere Attempt

NEW YORK—Short-wave listeners will again have the opportunity to tune in a thrilling real-life adventure when the 1935 National Geographic Society-U. S. Army Air Corps stratosphere flight will be made, probably the early part of June, from the strato bowl near Rapid City, South Dakota. The 1934 flight, which ended when the disintegrating balloon crashed to earth with the occupants parachuting to safety, provided countless thrills to short-wave fans as well as broadcast listeners who tuned in the portions of the communications relayed by NBC. This year again, NBC will rebroadcast the voices of the balloon's occupants.

Arrangements have already been completed for the cooperation of the NBC and
(Turn to page 49)

SHORT WAVES IN SCIENCE

Dr. G. A. Potakenko, of the California Institute of Technology, shown with his ultra-short-wave radio apparatus he is using in his study of the structure of matter.



TELEVISION! TO THE FRONT!

¶ The recent announcement of a comprehensive plan, backed by an initial appropriation of \$1,000,000, for the introduction and establishment of Television on a sound basis is one of the utmost importance to every corporation and individual affiliated with radio.

AFTER six years of effort on the part of the Radio Corporation of America to develop Television so that it would be commercially profitable to his corporation and to those who would manufacture and distribute sets and parts under licenses of that corporation, David Sarnoff has announced that Television will be taken out of the laboratory for definite tests in the field.

According to a statement issued by Sarnoff, the initial station tests will be made from an installation in the tower of the Empire State Building in New York City, or a remote possibility exists that the first of the proposed Television transmitters will be installed in the company's plant at Camden.

It is estimated that 12 to 15 months will be necessary to develop the plans and installations that will make placement of Television receiving sets into the homes of the nation a commercial possibility.

In other words, whether or not the Radio Corporation of America has been able to make this step before, it now definitely has put itself on record that it is moving one step closer to the next great development of the air.

It has been reported but never confirmed that the larger radio manufacturers have consistently put the brakes on the introduction of Television until they felt the financial status of the general public was such that it would be profitable, in view of the great investment necessary to accomplish this, to go ahead with their program.

During the development of radio broadcasting it was generally conceded that much of the growing prosperity of the nation was due to the fact that hundreds of thousands of people were put to work directly and indirectly supplying the nation's homes with sets, and roofs with antennas.

It is believed that when the Radio Corporation and other manufacturers are ready to produce practical Television receivers, so that one will be able to see, as well as hear the radio star or artist, the same great business boom in the radio industry will result. Television will mean a recurrence of that great volume of business that servicemen, department stores, and radio supply houses had with the advent of radio.

It is estimated that it will be at least fifteen months before the Radio Corporation is ready to say that they have developed this science to a point where it will be commercially feasible to put the

sets in the home. In the meantime, they are going far with experiments which include the transmission of motion pictures directly to theaters, avoiding the huge expense of carrying inflammable films from one place to another in armored trucks and out into the small towns where the distribution problem is now one of constant headaches to the film companies.

In the planning of a great department store in Pennsylvania, serious consideration was given to wiring the store so that with the development and release of Television, they could demonstrate the character of their wares over the air to customers by means of their own Television transmitter or by sponsored programs over local commercial stations.

This is stretching the point rather far at this time, but it gives evidence of the interest being manifested by the general public and big corporations in this development, and the announcement by Mr. Sarnoff, that his company is bringing Television out of the laboratory and into the field, means that they cannot retrace this step if that corporation really has the answer to the numerous problems involved.

It is understood that 15 months is required for experimental transmissions leading to the establishment of necessary station networks and to develop definite programs and a continuity of entertainment so that the home will have something to "see" before the receiving sets are offered for sale.

Mr. Sarnoff in his statement says that while Television promises to supplement the present service of broadcast by adding sight to sound, it will neither supplant nor diminish the importance and usefulness of sound broadcast.

RADIO NEWS feels that if at the end of this fifteen-month period R.C.A. has developed a program and general Television broadcast service sufficient to create a demand for receiving sets, the radio industry will again step out as a contender for honors as one of the five largest industries of America.

Each month we will definitely let you know what is being accomplished toward this end because it is incumbent upon everyone interested in radio in a commercial way, to keep his ear closer to the ground so that no opportunity will be missed to make more profitable existence, whether it be for the technical expert, the retail storekeeper, the serviceman, or the fan who derives his profit from entertainment.

Radio News

July, 1935

Build A Set!

LEARN RADIO

(The Editor—To You)

Many beginners in radio have found that their first real understanding of radio was initiated by building some kind of radio apparatus. The problems encountered, discussed and solved by a person making radio apparatus have often led to a determination to enter the radio field as a life's work, and numerous radio personalities now at the top started in this way

SET building is not only a pastime but an education in itself! It is true some indulge merely for the sport alone—what the set will get for them in the way of distant stations, quality of reproduction and satisfaction that the work of their own hands has been successful. Others build sets to acquaint themselves with new principles in radio circuit design and with the operation of new tubes, new amplifiers and methods of reproduction. They find that they can keep up with radio and continually educate themselves by building apparatus employing these newest improvements. Quite a number of important innovations in radio are made by such experimenters who envisage novel improvements in the varied developments they build. So true is this that a number of the leading radio schools include kits of parts to be built into sets by their students to impart the practical side to their theoretical courses. The wide-awake

serviceman can add substantially to his earned income by building new units for old sets that have failed in operation. Some successful servicemen do this and also build "custom" jobs for their discriminating clientele who want special installations for receivers in bookcases, in desks or special cabinets. Amateurs have always been rabid set builders, both of receiving and transmitting apparatus. It is interesting to note that in a recent survey some of the most successful servicemen were at one time, or are now, licensed radio amateurs. It is this ability of theirs *to build apparatus to cope with situations which are out of the ordinary* which has made them more successful!

So it is that set building and building of special instruments for radio measurements still continues in popularity. Lately, however, there has also been added a new group, with a special interest in set *(Turn to page 57)*

SEVEN HOME-BUILT SETS AND SEVEN AMATEURS THAT ARE PROUD OF THEM

A group of expert radio amateurs proudly exhibiting the portable transmitter and receiver combinations that they are using in checking radio reception in various parts of the Exposition Grounds of the World's Fair, to be held in San Diego, California, during the month of July.

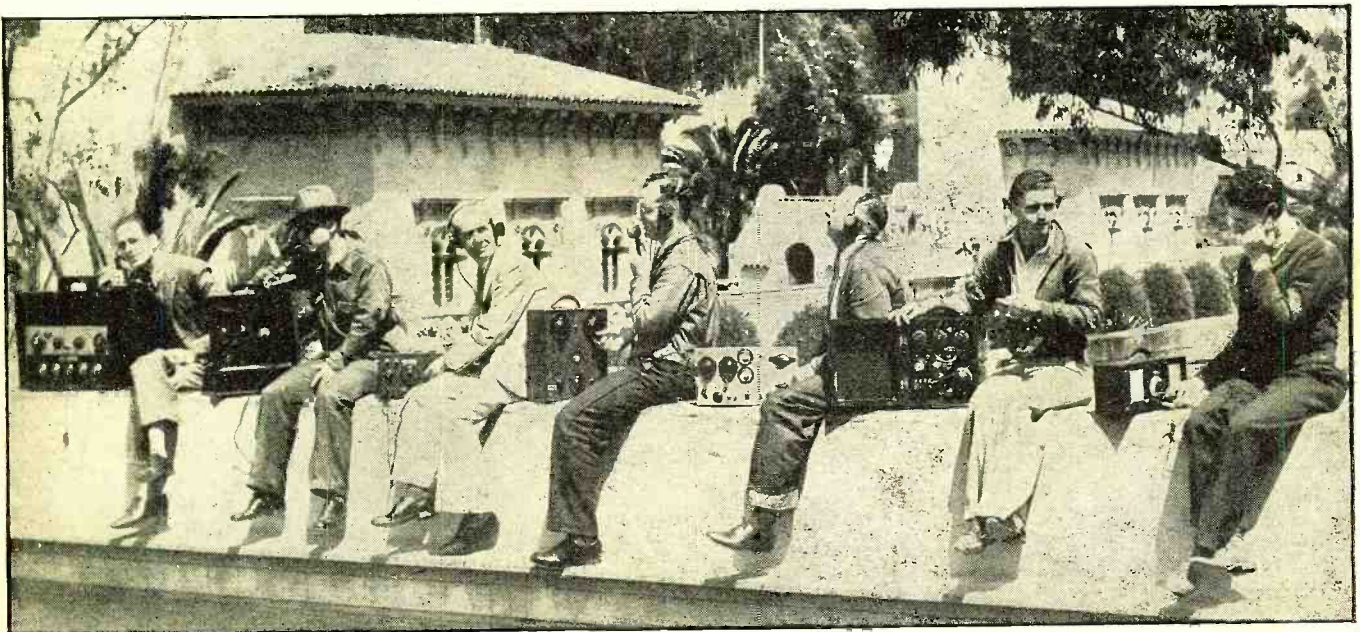

THE VALENTINE

DE

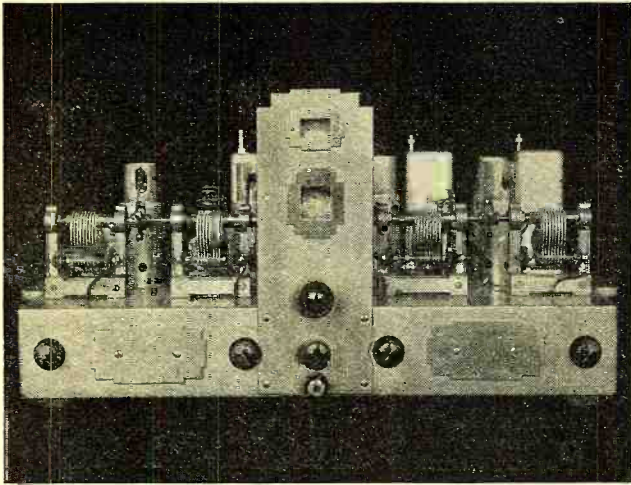

The receiver described in this series was his radio ideal. He is a mechanical engineer through combining his knowledge in both receiver which offers a wealth of ideas

B. Gordon

Part

COMPREHENSIVE operating tests of this receiver were conducted by RADIO NEWS, both in New York City and at the author's home in Western New Jersey. In both locations the receiver clearly demonstrated its universal excellence. It is one home-built receiver which meets the rigid—and often divergent—requirements of the DX'er and the critical music lover alike—*The Editors*.

BEFORE proceeding to describe the electrical and mechanical features of this tuner—designated V-8 for brevity in future references, the writer would like to present briefly several points related to its design as now presented.

Let it be said that the prime requisite aimed at was reproduction of broadcast programs—musical numbers in particular—as nearly perfect as could reasonably be expected under existing conditions of channel separation. This meant that in the first place, the tuner must be selective. When one considers that to obtain realistic reproduction of musical numbers a wide frequency response is required, the foregoing statement may sound somewhat paradoxical. With 10 k.c. channels however, one must be able to eliminate completely interference from adjacent stations in order to really enjoy any program—even though some sacrifice in fidelity is involved in so

doing. When conditions permit, however, it is desirable to have some convenient method for reducing selectivity and thereby improving fidelity. The new variable coupling intermediate frequency transformers introduced recently by the Hammarlund Manufacturing Co. provide a ready means for doing this, and their use greatly increases flexibility of operation.

The V-8 is for the broadcast band of frequencies 540-1650 k.c. only, as it was decided that the introduction of all-wave features would involve many complications. The writer's preference is to leave short-wave reception to apparatus designed specifically for that purpose, either in the form of a complete short-wave tuner, or of a good converter for use ahead of a broadcast tuner.

For variety in broadcast reception, particularly in locations at a distance from powerful stations, a tuner should be sensitive—and *the sensitivity should be usable*.

UNDER VIEW OF CHASSIS

The base plate is removed here to reveal the unusual chassis construction, in which each circuit is enclosed within its own "cell", effectively shielding it from all other circuits.

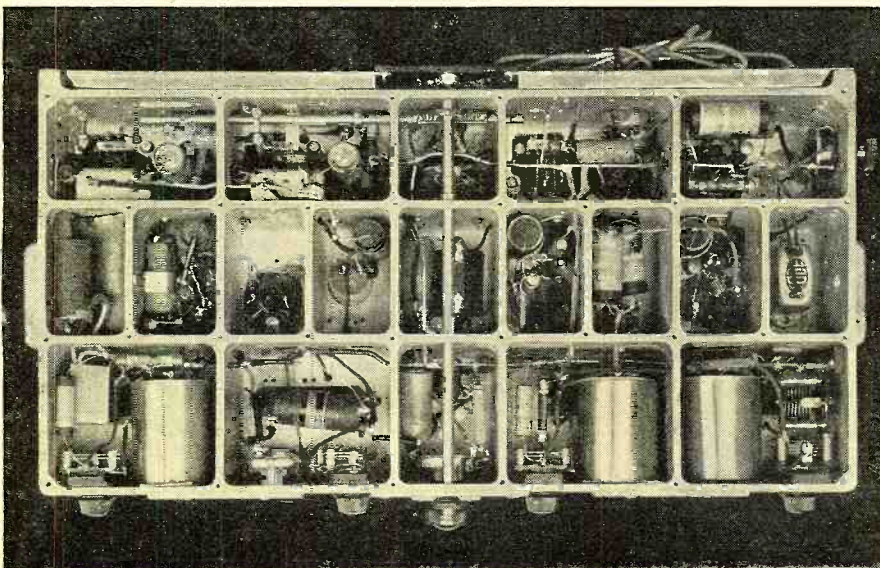

To achieve these various requirements no limitation was placed on the number of controls provided.

It might be said that mid-year of 1932 marked the beginning of a new era in receiver design. Whereas the tuned-radio-frequency set in its various forms had until then been the main standby, it was beginning to be replaced in public favor by the superheterodyne. New tubes in great variety were made available by the manufacturers. In common with countless others, the writer decided to try them out and, in order to capitalize on the full capabilities of the r.f. pentodes it was decided to pay particular attention to circuit filtration and interstage shielding.

With these definite aims in view a circuit was selected as follows: two stages of radio-frequency amplification using 58 pentodes, a 57 modulator and 56 oscillator, two stages of i.f. using 58's, followed by two 55's with their diodes in parallel as a half wave 2nd detector and a.v.c. source, and the triode sections in parallel as a stage of audio amplification.

Many layouts were tried, to give the best sequence of stages in arrangement of the chassis, with due regard to simplicity and directness of wiring, etc. A conventional steel chassis and numerous copper shields were made, remade and altered until the original carefully constructed chassis took on the appearance of the proverbial Swiss cheese. It was felt, nevertheless, that experience and information so gained justified the building of another tuner and the hope was entertained that this one would be a more permanent and less ventilated model than its predecessor. Several essentials for the attainment of satisfactory results had been made evident: (1) rigidity of the chassis, (2) more than ordinary care in shielding and filtration, and (3) high grade components.

In the writer's opinion (1) was met by a casting, and this preference extends to (2) also. Item (3) involved a little higher initial outlay for parts but saved many recriminations and further outlay at a later time.

On the strength of these convictions,

“SUPERHET”

LUXE

designed and built by Mr. Valentine to meet by profession, with radio as a hobby, and fields has developed a truly remarkable to those interested in set construction.

Valentine

One

and giving due consideration to physical size and its relationship to circuit efficiency, an aluminum casting 20¾ inches long, 11 inches wide and 3 inches deep was made from a carefully constructed pattern. An alloy with minimum iron content was used. One of the photographs shows the cellular construction employed. The top and bottom surfaces were disc ground, and grooves milled in the upper surface for wiring. The writer is aware that this class of work may be somewhat out of the realm of the average radio fan, and considers himself fortunate in having facilities for doing it.

The general arrangement of the chassis is such that the r.f. signal progresses from left to right along the front of the chassis—the modulator being at the right front. The i.f. signal progresses from right to left along the back. As there was the possibility of the tuner being at some distance from its associated amplifier and power supply a filament transformer was included in the tuner. A 5-pin plug located at the back provides connections for plate, screen, and a.c. line supply, and ground. The enclosed space ½-inch wide at the back of the chassis contains filament, screen and a.v.c. leads for the i.f. amplifier. The output lead from tuner to amplifier is at the left rear where it is removed from other connecting wires. The 265 and 125-volt leads are run in the covered transverse and longitudinal grooves, branches being taken to the various compartments containing tube sockets and filters. A deep longitudinal groove carries the plate lead from the third r.f. transformer to the 2nd r.f. tube plate. This groove is separate from the other. Antenna and ground connections are made to pin jacks through the left-hand wall of the chassis adjacent to the 1st r.f. transformer. The audio volume control knob is located on the left-hand end, toward the back. This position may seem rather unusual, but was chosen primarily because the potentiometer which it operates is close to the diode where it belongs, and secondly because the tuner is set on top of a speaker cabinet, and

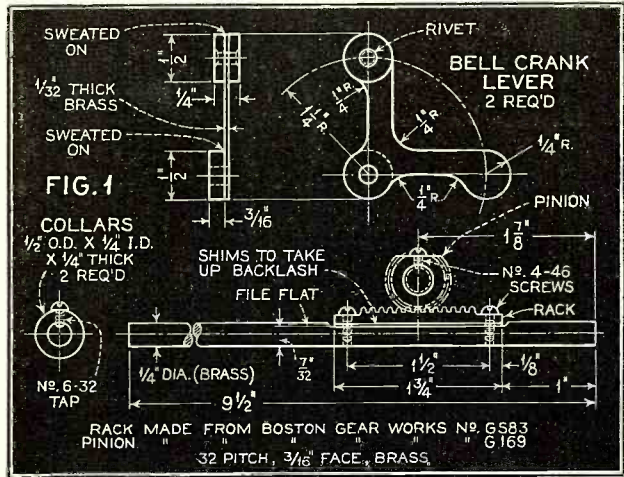

the control is convenient to the left hand when tuning with the right hand.

From left to right along the front of the tuner are 1st and 2nd r.f. trimming condensers, and omitting the controls on the centre panel, the oscillator and 3rd r.f. trimmers. From top to bottom in the center panel are the tuning meter, frequency indicating dial, frequency selector, and i.f. gain control. Below this is what at first sight might appear to be a simple control, but in reality is dual, the large knob controlling the variable coupling of the coils in the first two i.f. transformers, and the hexagon shaped one being the a.v.c.—no a.v.c. switch control. The large knob is attached to a brass tube running through to the back of the chassis where a pinion is mounted on it. The teeth of the pinion engage with those of a rack attached to a push rod sliding transversely in guides in the chassis. This push rod carries collars, each of which bears on one arm of levers whose other arms are in contact with the

ONE of the important features of the Valentine receiver is the front panel control which at one extreme provides wide-band, high-fidelity reproduction; and at the other carries selectivity to the extent of radical side-band cutting. This is accomplished by means of variable coupling coils in the i.f. transformers, gang controlled by mechanical arrangement shown above—*The Editors*.

spring-returned push rods carrying the plate coils, in two of the Hammarlund i.f. transformers. This sounds rather involved, but a glance at Figure 1 should make it clear. Rotation through about 90 degrees of the panel control gives ¾ inch movement of the plate coils, and with the adjustments provided on the transformer push rods and on the rack push rod, any fraction of this maximum movement can be obtained. To prevent rattles developing due to vibration the bell crank levers are slightly loaded at their bearings by means of a light spring mounted on the pivot pin. To offset the effect of friction so introduced, the ends of the levers in contact with the transformer push rods are weighted, thus relieving the springs in the transformers of all duty other than returning the coils to the position of minimum coupling. A control of radio-frequency gain is provided on the left-hand side of the chassis. (Turn to page 44)

THE CHASSIS

The way the receiver appears with the stage shields and overall cover removed. The two straps set into the chassis top are the covers of grooves in which certain of the wiring is laid, and thus shielded.

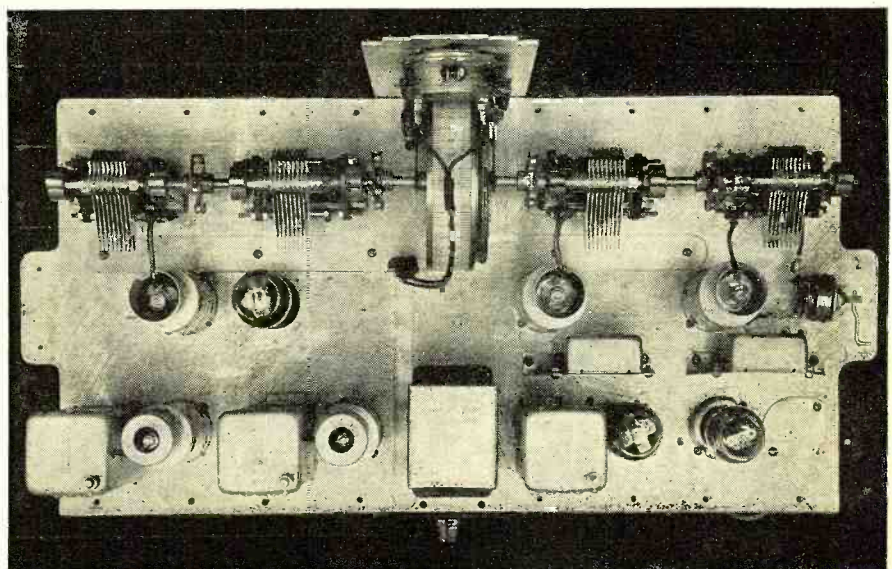



AN ELECTRIC ORGAN USING DISKS—NOT PIPES

Shown above are two views of the new electronic musicmaker, played by a standard organ console. The upper right view shows a series of twelve photo-electric cells in front of the disks.

MUSIC from Whirling DISKS

Samuel Kaufman

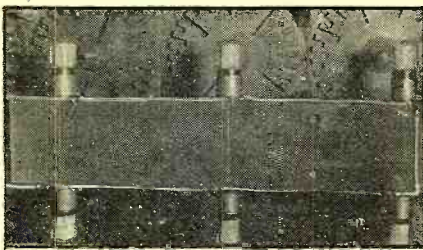
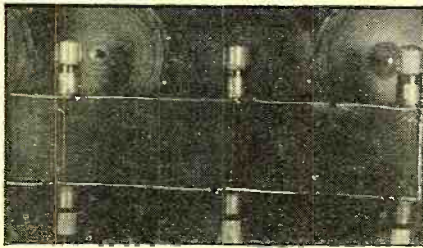

WHIRLING—AND STATIONARY

The two views above show the disks in motion and at rest.

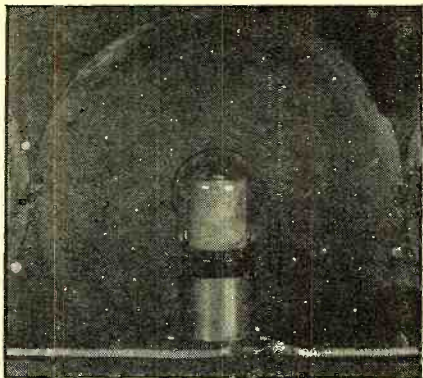

AN electronic organ, known as the photona, was recently introduced to radio listeners during a special Columbia Broadcasting System program originating in the studios of WCAU, Philadelphia. The new musical instrument employs radio and photo-electric equipment to achieve novel tone effects and the device was heralded as an important contribution to the field of music.

The experimentation leading to the perfection of the instrument was instituted by officials of the Philadelphia station and the photona was constructed under patents held by Ivan Eremeeff, of the station's electronics music lab-

oratories. The development work included tests with several types of sound production motion-picture film, rotating disks, and other apparatus, and it was finally determined that the present instrument was most suitable for the work intended. All of the creative work was done by Eremeeff and assistant WCAU engineers. The model now in the WCAU studios is the only instrument of its kind, but there is likelihood of general production if a demand so warrants, a station representative said.

Two manuals, each comprising six octaves, are utilized on the photona. The keys in the manuals serve as switches to light (Turn to page 59)

THE PRINCIPLES INVOLVED IN THE INVENTION

The heart of the new machine is the revolving disk shown at the left, with its associated photo-electric tube. Behind the disks are many lamps. The disks are driven through pulley wheels by an electric motor, as indicated below at the left. The diagram at the right shows the hookup used between the keys and the lamps, to throw interrupted beams of light through the disks onto the photo-cell. The photo-cell works through an amplifier attached to a loudspeaker.

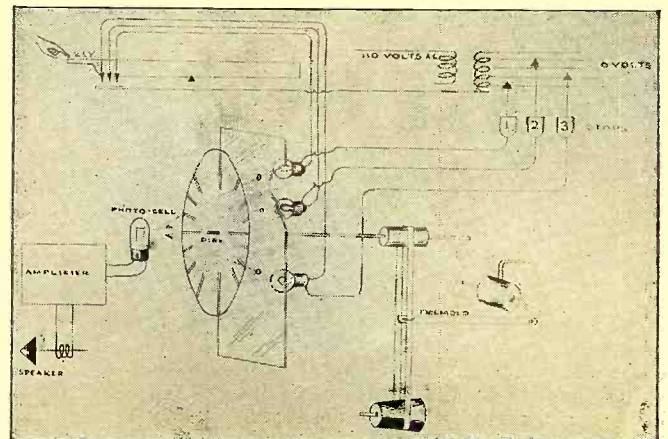
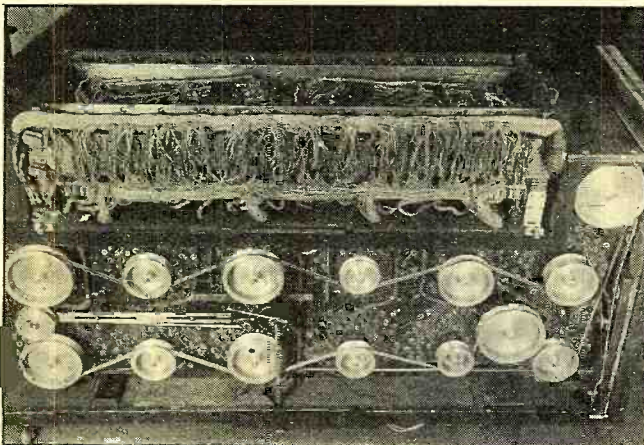

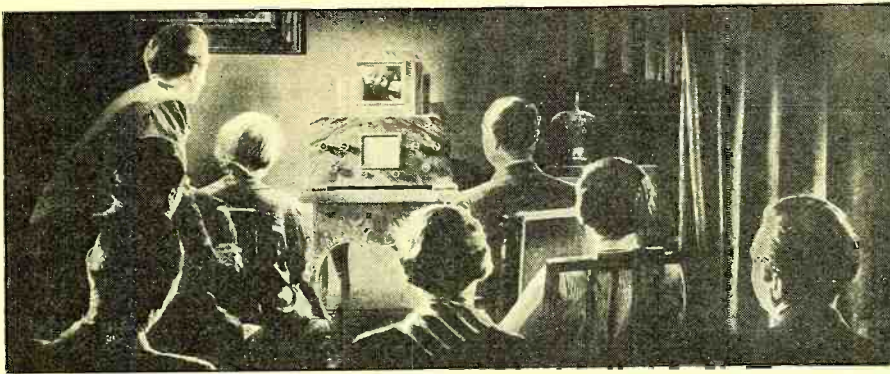

CONVERTING THE HOME INTO A MOVIE HOUSE
 Here is an actual picture taken in the home of a Berlin family showing how talking movies are received, visually and aurally, on the short waves by television. At right: two German women announcers, Fraulein Ursula Patzschke and Fraulein Annemarie Beck.



MICKEY MOUSE ON THE SCREEN
 The three pictures below show the cartoon character as actually received and two types of receivers.

German TELEVISION

Wilhelm E. Schrage

WHILE America is still of the belief that television has not advanced sufficiently for general use, England and Germany are now endeavoring, through the aid of their respective governments, to make television as popular as broadcasting. Other European countries are following in their footsteps, and it can be truthfully said that Europe is now in the throes of "television fever."

FOUR HUNDRED AND FIFTY-THREE feet in the air, rising slightly above the top of the well-known Berlin radio tower, with its famous restaurant, two copper rings appear to be growing in the sky. Each has a diameter of about ten feet, and their surfaces shine in the early spring sun like spun gold. They are symbolic of a new era—television is no longer a mere technical problem, but is being made available for the use of the general public. The golden rings are the antennas of the Berlin Television Station. From these high points, far above the surrounding buildings, radio waves of a special kind—ultra-short waves, as

the technicians term them, are radiated into the air by a force of 15 kilowatts, covering an area of about 50 miles in diameter. Each of these television stations has two ultra-short-wave transmitters. One radiates the sound impulses, as usual, while the other one delivers the picture impulses to be shown in the home transmitter. The radio listener, or should we say the "television looker," uses a special television receiver to receive these transmissions. Pictures of home-movie size are reproduced. These receivers are of two sizes, one having a screen of about 4 inches by 6 inches and the other about 10 inches by 12 inches.

It is simple to tune in on television programs, because there is plenty of space in the present wave range, which is about 7 meters. In other words, there are far less stations in this wave range than in the normal broadcast band, and the selectivity of the television receiver does not have to be as great as for plain broadcasting. Also, the "monkey chatter" does not occur, (Turn to page 60)

GERMAN TRANSMITTING AND PICKUP APPARATUS

The ultra-short-wave transmitter in Berlin showing one of the shielded stages being equipped with a new tube. At right: the television newsreel pickup bus on location.

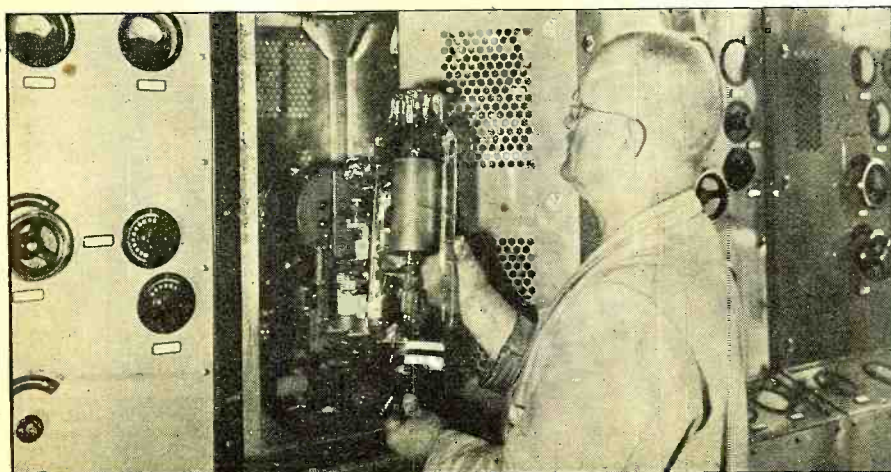
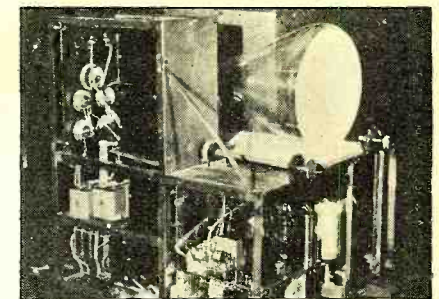
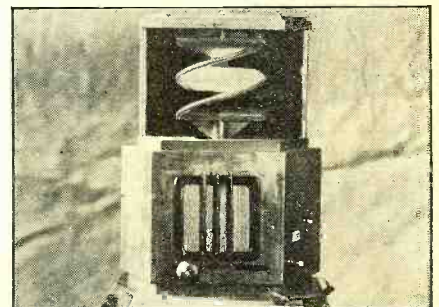
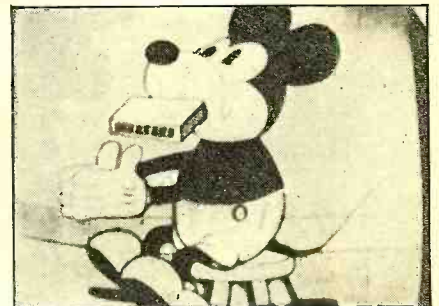

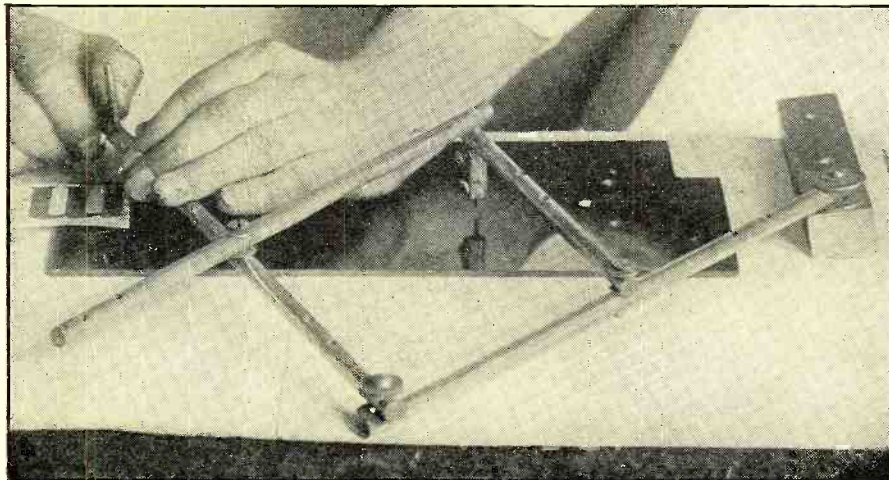

How to Make A PANTOGRAPH ENGRAVING TOOL

An easy to make tool with which the constructor can copy (engrave) lettering or designs directly on insulation or soft metal panels

Sylvester Bruzas

WITH the simple home-made engraving device described in this article it is possible to engrave neat letters and numerals on bakelite, rubber, and the softer metals. Designs and drawings may be engraved as easily as numerals and letters; and, by replacing the cutter with a pencil, lead copies of drawings and designs may also be obtained.

The device is simply a modified pantograph. It consists of four metal rods arranged as shown in Figure 1. A cutter point is attached to the two middle arms at the point E. A stylus is attached to the right-hand arm at C, while the lower end of the left-hand arm is loosely screwed to a block of wood at the point A. The block of wood is clamped to a table when the device is in use. For the benefit of those not familiar with the pantograph, a few words of explanation follow.

AB, BC, DE, and EH, in Figure 1, represent the four arms of the pantograph. The arms are pivoted at points A, D, E, B, and H. Since AB is equal in length to BC, AEC will lie in a straight line, as shown by the dotted line, when DE is equal to AD, HC, and HE. If a stylus is now placed at C and a cutter at E, any letter traced by the stylus will be engraved by the cutter. The size of the engraved letter is to the size of the master letter as AD is to AB. It is obvious that the engraved letter will always be smaller than the master letter when the cutter is placed at E.

Placing the cutter at C and the stylus at E results in an enlarged engraving of the master letter traced by the stylus.

Any degree of enlargement or reduction may be obtained by shifting the positions of the two middle arms and the position of the cutter. The arms, however, must be arranged so that AD is always equal to DE, EH, and HC.

So far as engraving is concerned, best results are obtained when the cutter is placed at E, as this results in an engraving reduced in size. This is an advantage, as a larger master letter is easier to trace with the stylus. Engraving will be covered more fully after the construction of the pantograph has been explained.

The arms of the pantograph may be made of iron or brass rods 14 inches long and $\frac{3}{8}$ inch square. No. 10/32 machine screws hold the arms in place. A hole is drilled 1 inch from each end of rod AB and another midway between the centers of the two holes. The hole at A should be just large enough to take the wood screw which screws into the

block of wood. A No. 24 drill and No. 10/32 tap are used at D, and a No. 11 drill at B. All three holes in arm BC are made with a No. 24 drill and then tapped, and are located at the same points as in arm AB. A No. 11 drill is used 1 inch from one end of arm DE and at the center. A No. 24 drill and No. 10/32 tap are used 1 inch from one end of arm EH, and a No. 11 drill at the center.

It is of the utmost importance that all holes be drilled perpendicularly; otherwise the machine screws will not fit. Forcing the screws into holes that are not in line will cause the arms to stick. Accurate engraving can be accomplished only when the arms are free to swing easily in all directions.

The cutter-holder is shown at b. It may be made of the same material as the arms and it should not be more than 1 inch long. One end is tapped with a No. 10-32 tap so that the holder may be screwed onto the machine-screw at E. A hole, large enough to hold the cutter, is drilled in the other end of the holder. Number 6-32 set-screws hold the cutter and holder rigidly in position. The holes for the set-screws are drilled with a No. 37 drill and then tapped with a No. 6-32 tap. A drill and tap of this size is also used for the set-screw that holds the stylus. A No. 10-32 machine-screw, which has been filed to a point at one end, serves as a stylus. The arms may now be assembled, and with the exception of the cutter the device is completed.

A good cutter may be obtained by breaking off a piece (1 inch long) from the tang of an old file and filing one end to a four-sided pyramid. Engraving is done with the apex of the pyramid.

Constructed according to the above directions the pantograph will engrave letters that are one-half the size of the master-letters—the ratio of AD to AB in this case is $\frac{6}{12}$ or $\frac{1}{2}$. Other ratios can be obtained by drilling additional holes in each of the arms.

Suppose that the letter A, $\frac{1}{4}$ inch high, is to be engraved on a panel. The master letter is first drawn with a pencil on a piece of paper. The letter should be drawn in thin lines so as to make the operation of tracing less difficult. The master letter, of course, must be drawn twice as large as the desired engraving. The pantograph and panel are now clamped to a table and the arms adjusted so that the cutter touches the panel at the (Turn to page 60)







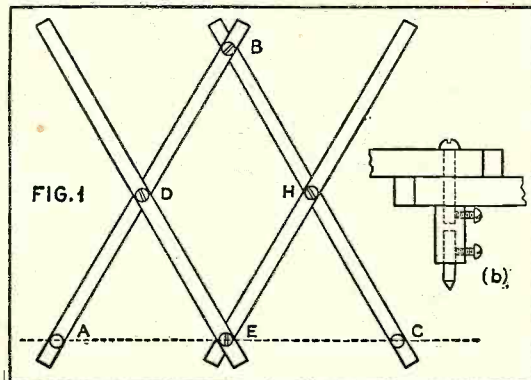



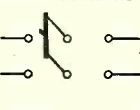



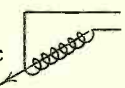

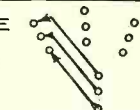
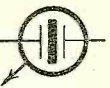
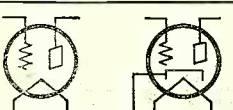
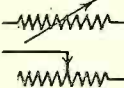
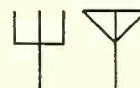

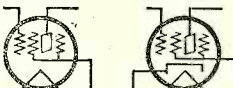
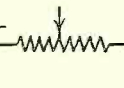
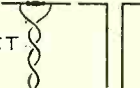

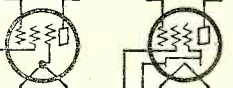

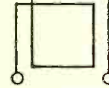

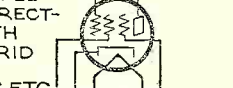

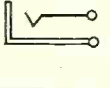
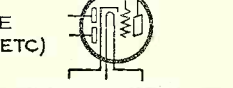

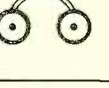

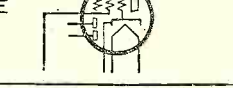

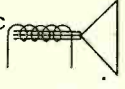

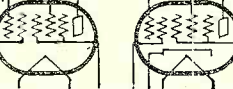
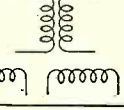
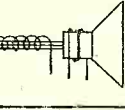

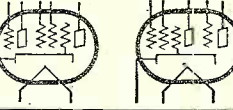
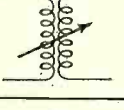
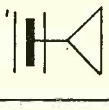
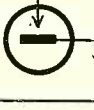
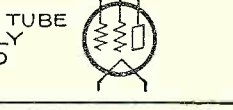

A SAMPLE OF ENGRAVING

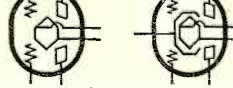
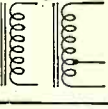
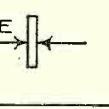
Below is an engraving made by the author on bakelite. The name on the cover of this magazine was the "master" he used

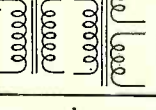
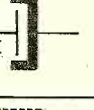
**RADIO
NEWS**

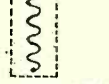

RA NEWS SYN B AR

WIRES CONNECTED 	DOUBLE POLE-DOUBLE THROW SWITCH 	CRYSTAL MICROPHONE 	HALF-WAVE RECTIFIERS (81-84 ETC) 
WIRES NOT CONNECTED 	SINGLE DECK MULTI-POINT SWITCH 	MAGNETIC PICKUP 	FULL-WAVE RECTIFIERS (80, 25Z5 ETC) 
FIXED RESISTOR 	MULTIPLE DECK MULTI-POINT SWITCH 	CRYSTAL PICKUP 	TRIODES (01A, 27 ETC) 
VARIABLE RESISTOR 	AERIAL 	SINGLE CELL 	SCREEN GRID TUBES (22, 24 ETC.) 
POTENTIOMETER 	DOUBLET 	BATTERY 	PENTODES (47, 2A5, ETC.) 
FIXED CONDENSER 	LOOP 	FUSE 	PENTODE OR TRIPLE GRID TUBE INDIRECTLY HEATED, WITH SUPPRESSOR GRID PRONG. 57, 58, 6D6, 6C6 ETC. 
VARIABLE CONDENSER 	GROUND 	OPEN CIRCUIT JACK 	DOUBLE DIODE TRIODE (55, 75 ETC) 
ELECTROLYTIC CONDENSER 	PHONES 	RECTIFIER 	DOUBLE DIODE PENTODE (2B7, 6B7) 
AIR CORE INDUCTANCE 	MAGNETIC SPEAKER 	METERS 	PENTAGRID TUBES (1A6, 6A7) 
COUPLED R.F. COILS 	DYNAMIC SPEAKER 	POWER LINE PLUG. 	TRIODE PENTODE 6F7 
VARIO-COUPLER 	CRYSTAL SPEAKER 	HALF-WAVE RECTIFIER COLD CATHODE, GASEOUS. 	DOUBLE GRID TUBE DIRECTLY HEATED 49, 46. 
VARIO-METER 	CARBON MICROPHONE SINGLE BUTTON 	FULL-WAVE RECTIFIER COLD CATHODE, GASEOUS. 	FULL-WAVE CLASS B TUBES (19, 53, ETC.) 
IRON CORE COIL (A.F. CHOKE) AUTO-TRANSFORMER 	CARBON MICROPHONE DOUBLE BUTTON 	NEON (GLOW) TUBE 	WUNDERLICH 
TRANSFORMER 	CONDENSER MICROPHONE 	PILOT LAMP 	TRIPLE TWIN 2B6 
SINGLE POLE SINGLE THROW SWITCH 	VELOCITY MIKE (RIBBON) 	PHOTO CELL 	RECTIFIER-POWER-PENTODE 12A7 

BUILD THIS MIDGET

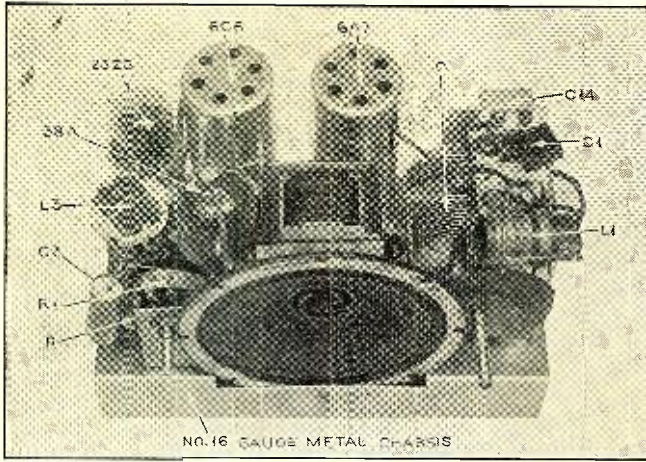

THE FINISHED CHASSIS

This view of the chassis will enable the constructor to duplicate the model layout.

THE usual minimum number of tubes used in universal "transformerless" superheterodyne circuits is 5 tubes. The "super" presented here uses only 4 tubes yet has enough sensitivity to operate on a short aerial. The tubes are so chosen as to be adaptable to battery operation and the power dissipation is unusually low. The tubes employed are the 6A7, the 6C6, the 38A and the 25Z5 tubes.

The 77 tube is superior in sensitivity to the 6A7 tube, a superiority which manifests itself in the somewhat stronger reception of weak signals. The aim of this design, however, is primarily local reception, and the 6A7 can therefore be used to greater advantage than any other tube. It is more flexible, has a high conversion factor, and simplifies the design of the oscillator circuit. Moreover, the 6A7 is less critical than any other tube as to the coupling requirement.

The author believes that the 6C6 is the most sensitive detector tube available on the market. This peculiarity has not been, so far, well exploited. The 38A is a further improvement of the old

38 automobile power output tube. It is similar to the 38 tube in plate and heater voltage requirements, but is a quick heater type.

The circuit (Figure 1) consists of one oscillator-modulator stage, one regenerative detector stage, and a stage of audio-frequency power amplification.

The antenna coupler, L1, is peaked at about 550 kc. and is tuned by means of one section of the 2-gang variable air condenser C. The oscillator coil is tuned by means of the other section of the 2-gang variable condenser C. The intermediate frequency output of the 6A7 tube is 456. The coils are so placed that no magnetic or capacitive coupling occurs and the only interaction is electron coupling inside the 6A7 tube. The biasing resistors, R1 (fixed), plus R (variable) are shunted by a 0.1 mfd. tubular paper condenser C3. Obviously the volume is controlled by the change of the bias of the control grid (grid 4) of the 6A7 tube. The plate section of the oscillator modulator comprises a 465 kc. transformer feeding into the fixed regenerative detector circuit of the 6C6 tube.

The necessity of using a low screen voltage in the pentode types of detector tubes is being realized more and more

by radio engineers. To attain this, a dropping resistor of 0.25 megohms shunted by 0.1 mfd. tubular paper condenser C6 is used. These values will take care of the dynamic operation of the 6C6 tube and will bring about maximum fidelity without appreciable lowering of tube sensitivity.

The 6C6 is self-biased by means of resistor R4, shunted by the 10 mfd. electrolytic condenser, C5. The suppressor of the 6C6 is strapped to its cathode. A .0005 mfd. high-grade mica condenser C7 is used as the plate bypass.

Using Regeneration

The unique feature of this design is the utilization of the 6C6 as a fixed regenerative detector, part of the amplified intermediate frequency is reflected from the plate to the grid circuit through the C16, L3 channel. This renders the set very selective and sensitive. It thus has, with less parts, the equivalence in performance of a 5-tube superheterodyne receiver. The mechanical construction of the 6C6 tube necessitates its shielding.

The power amplification stage, utilizing the 38A tube, is coupled to the detector through resistor R6. The grid resistor R8, in conjunction with the coupling condenser C8 of 0.03 mfd., affords a maximum input to the power stage. The 38A tube is self-biased.

The 25Z5 is used as a rectifier. Its two cathodes are used separately in order to attain maximum voltage for the plates of the tubes. One cathode energizes the field of the dynamic reproducer while the second cathode supplies the necessary plate, grid, and screen voltages.

For operation on light lines, the heaters of the four tubes are connected in series and the line voltage is reduced by means of the dropping resistor R10. The sequence of the connection of the heaters of the various tubes as shown in the schematic diagram should be strictly followed as this arrangement was found to give a minimum amount of hum. For automobile use, an adapter makes possible the connection of the heaters in parallel and the introduction of a separate B supply.

A 110-volt neon pilot light, V, has been incorporated in this design. How sensitive this set is may be appreciated

THE CIRCUIT DIAGRAM

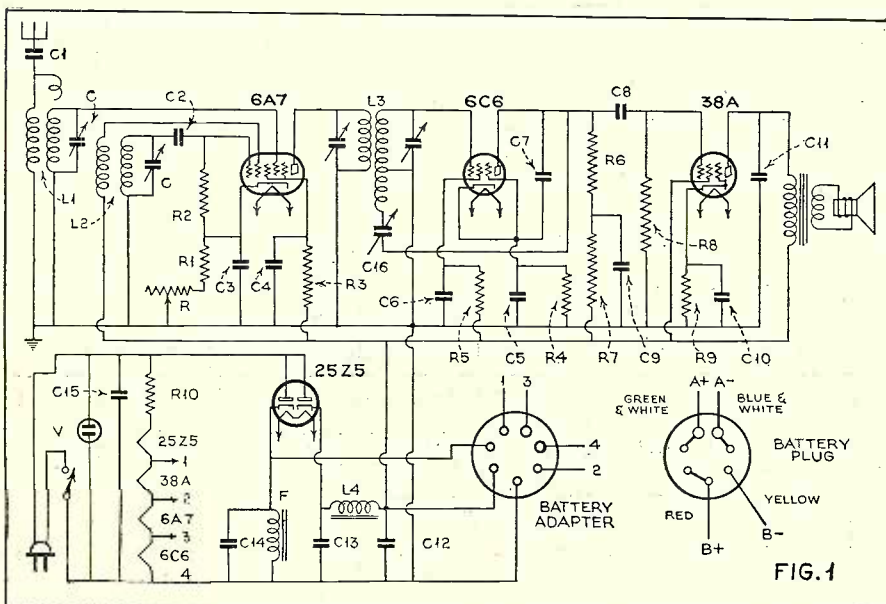

RADIO RECEIVER

George Day

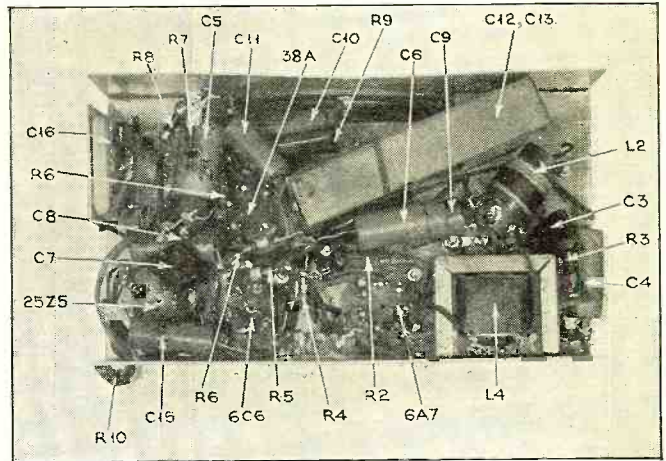

from the fact that with only 25 feet of indoor aerial and no ground connection, distant stations such as WLW, Cincinnati, and WTAM, Cleveland, were received with good volume at a location in New York. The selectivity of the receiver is about 30 kc. The receiver chassis is probably one of the smallest yet designed; its dimensions being 8¼ inches by 4½ inches by 1⅝ inches.

The complete specifications for the chassis are given in Figure 2 for those who desire to fabricate this at home. The layout of parts is easily followed from the photographs.

The oscillator coil has been calculated to 130 microhenrys. If such a coil is not available, it can be constructed as follows: Wind closely on a ¾-inch tubing, 100 turns of No. 32 enamel covered wire. Over this tuning section, starting from the ground end of the coil, wind in the same direction 50 turns of the same size wire. These two windings should be separated by impregnated paper of not less than 1/32 inch thickness. The terminal of the coupling winding nearest the ground end of the tuning coil should go to the oscillator plate of the 6A7, grid number 2, while the other end of the coupling coil goes to B plus. The high end of the tuning section goes to the oscillator grid of the 6A7 tube, (grid number 1).

Adding the Tickler

If the unshielded 456 transformer, L3, employed does not contain a feed-back winding, this section can be easily constructed as follows: Scramble wind 60 turns of number 40 enamel copper wire on a sleeve (tubing) that is tight fitting on the dowel of this transformer. This tubing should be placed next to the grid coil of the transformer. The feed-back winding should be in the same direction as the grid coil winding.

Connect the inside terminal of the feed-back winding to the outside terminal of the grid coil which goes to ground. The outside terminal of the feed-back winding should be connected to the moving part of the padding condenser, C16.

By moving the tubing to and from the grid coil an additional method of adjusting the regeneration of the detector is afforded to that of the padding condenser C16.

If the set builder has no oscillator, the following procedure may be followed in lining up the circuits.

Set the 2-gang variable air condenser very close to the minimum capacity position and adjust trimmers until a 1500 kc. station is heard. First adjust the trimmer on the modulator section of the condenser (front section). Then adjust the trimmer on the oscillator section for maximum output, keeping the 2-gang variable air condenser at the 1500 kc. position. The station may sound weak at this stage of adjustment. Then adjust the transformer trimmers for maximum output.

Now find the weakest station on the dial. It may be some station which is not favored by your locality or it may be a distant station. After setting the 2-gang variable air condenser at this position, adjust the regeneration control padding condenser C16 almost to the point of oscillation. Turn the dial to the strongest station and see if the set does not oscillate. It usually will not oscillate. If it does, decrease the regeneration a little by resetting the padding condenser C16.

At this point it may be necessary to readjust both trimmers slightly on the transformer because the feed-back decreases the effective resistance of the secondary winding of this transformer. Although an appreciable frequency shift can hardly be expected, the shape of the resonance curve due to the change of the effective resistance will be appreciably. This change will tend to narrow the selectivity curve and hence a sharp side band cutting will be noticed. By readjusting the trimmers on the transformer this side band cutting effect of the regeneration can be largely nullified.

List of Parts

- C—General Instrument midget 2-gang variable air condenser, clockwise type, oscillator section cut for 456 kc. i.f.; t.r.f. section 365 mmfd., shaft 2" long, ¼" diameter
- C1—Solar mica condenser 0.001 mfd. 200 volt peak
- C2—Solar mica condenser, 0.00025 mfd., 200-volt peak
- C3, C4, C6, C9—Solar tubular paper condensers 0.1 mfd., 175-volt peak
- C5, C10—Solar dry electrolytic tubular condensers 10 mfd., 35-volt peak
- C7—Solar mica condenser 0.005 mfd., 200-volt peak
- C8—Solar tubular paper condenser 0.03 mfd., 175-volt peak
- C11—Solar tubular paper condenser 0.006 mfd., 175-volt peak
- C13, C12—Solar dry electrolytic condensers dual 16-8 mfd., 175-volt peak
- C14—Solar dry electrolytic condenser 8 mfd., 175-volt peak
- C15—Solar tubular paper condenser 0.05 mfd., 175-volt peak
- C16—Hammarlund padding condenser 450 mmfd. maximum.
- L1—Gen Ral Type RFB No. 4 antenna coil
- L2—Gen Ral Type RFB No. 4 oscillator coil
- L3—Gen Ral Type RFB No. 4 i.f. transformer with feed-back winding, 456 kc.
- L4—Kenyon 30 henry, 40 milliampere choke, 300 ohms
- R—One Stackpole 5000-ohm potentiometer with line switch
- R1—Micamold resistor, 150 ohms, ½ watt
- R2, R4—Micamold resistors 25,000 ohms, ½ watt
- R3—Micamold resistor 30,000 ohms, ½ watt
- R5—Micamold resistor 0.25 megohm, ½ watt
- R6—Micamold resistor 0.5 megohm, ½ watt
- R7—Micamold resistor 100,000 ohms, ½ watt
- R8—Micamold resistor 2 megohms, ½ watt
- R9—Micamold resistor 1500 ohms, 1 watt
- R10—Gavitt line cord with resistor 250 ohms, 25 watts
- V—General Electric neon glow lamp, 110-volt type

UNDER THE CHASSIS

All parts are numbered to correspond with the list of parts at the end of the article.

- ers dual 16-8 mfd., 175-volt peak
- C14—Solar dry electrolytic condenser 8 mfd., 175-volt peak
- C15—Solar tubular paper condenser 0.05 mfd., 175-volt peak
- C16—Hammarlund padding condenser 450 mmfd. maximum.
- L1—Gen Ral Type RFB No. 4 antenna coil
- L2—Gen Ral Type RFB No. 4 oscillator coil
- L3—Gen Ral Type RFB No. 4 i.f. transformer with feed-back winding, 456 kc.
- L4—Kenyon 30 henry, 40 milliampere choke, 300 ohms
- R—One Stackpole 5000-ohm potentiometer with line switch
- R1—Micamold resistor, 150 ohms, ½ watt
- R2, R4—Micamold resistors 25,000 ohms, ½ watt
- R3—Micamold resistor 30,000 ohms, ½ watt
- R5—Micamold resistor 0.25 megohm, ½ watt
- R6—Micamold resistor 0.5 megohm, ½ watt
- R7—Micamold resistor 100,000 ohms, ½ watt
- R8—Micamold resistor 2 megohms, ½ watt
- R9—Micamold resistor 1500 ohms, 1 watt
- R10—Gavitt line cord with resistor 250 ohms, 25 watts
- V—General Electric neon glow lamp, 110-volt type
- One Eby 7-prong socket for 6A7 tube
- One Eby 7-prong socket for automobile adapter

CHASSIS SPECIFICATIONS

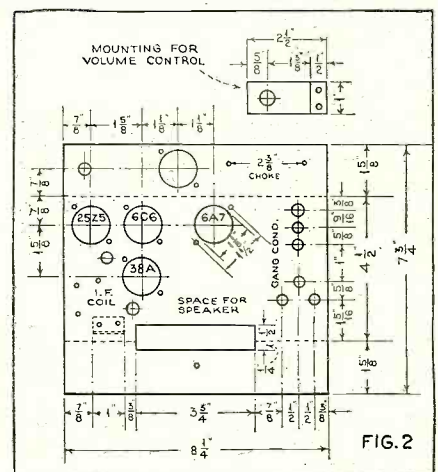

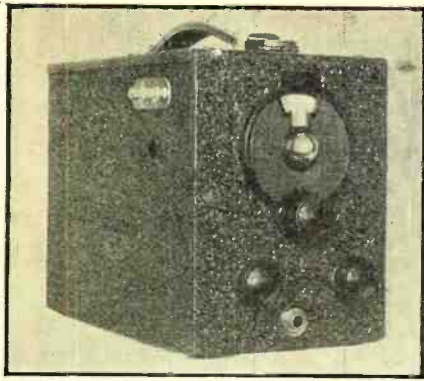

New S. W. PORTABLE

A SIMPLE, easily assembled short-wave receiver that is available in kit form is the "Band-Spread Portable," so called because the entire set, including filament and plate batteries, is contained in a black enameled steel carrying case only 8¾ by 6¾ by 5¼ inches overall. Tapped plug-in coils give comfortable band spreading on the short-wave broadcast and amateur channels.

Two type 30 tubes are used in a reliable regenerative-detector, one-stage audio circuit, as shown. A 140 mmfd. midget con-

WAVE BAND METERS	SECONDARY		TICKLER, NUMBER OF TURNS	TRIMMER CAPACITY MMFD.*
	NUMBER OF TURNS	TAP FROM BOTTOM		
19	4½	1¼	4¾	80
25	4½	1¼	4¾	180
31	11½	4¾	6	180
49	11½	4¾	6	180

* VARIABLE CONDENSER INSIDE COILS. VALUES SHOWN ARE MAXIMUM. ALL SECONDARY COILS ARE WOUND WITH NO. 24 BARE WIRE SPACED TO A WINDING LENGTH OF 1¼". TICKLERS ARE CLOSE WOUND WITH NO. 28 OR 30 S.C.C. WIRE.

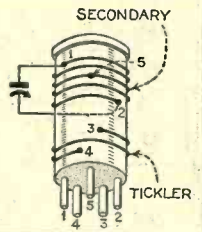

denser, operated by a small vernier dial, is the main tuning control, while regeneration is adjusted by means of a 1-megohm variable resistor in the detector plate lead. A large 4½-volt C battery is used for filament supply and a single 45-volt B battery for plate voltage.

The steel case is supplied in two sections, which merely bolt together. A hole in the top, protected by a sliding cover, permits insertion and removal of the plug-in coils.

The Band-Spread Portable is intended for earphone operation. When used with an outside aerial it is capable of good foreign reception of short-wave broadcasting stations. It also makes an effective monitor for the amateur station.

The complete kit of parts for this set, as supplied by Wholesale Radio Service Co., Inc., contains the following:

- L1—2-winding; 5-prong band-spread coils
- RFC—2.2 mh. r.f. choke coil
- C1—140 mmfd. midget variable
- C2—.00025 mfd. mica grid condenser
- C3—.0005 mfd. mica by-pass condenser
- C4—.5 mfd. paper by-pass condenser
- C5—Trimmer condensers built into coils
- C6—2-plate, 5 mmfd. antenna trimmer.
- R1—1,000,000-ohm potentiometer
- R2—8-ohm wire-wound resistor
- R3—10-megohm grid leak

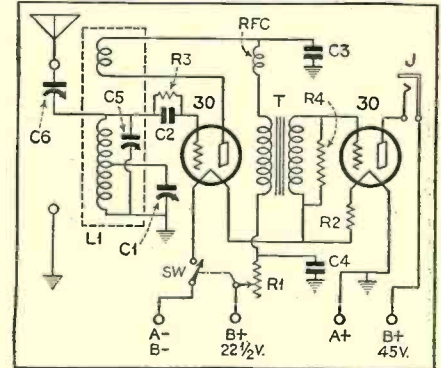

- R4—1-megohm grid leak
- J—Single open-circuit phone jack with insulating washers
- T—3½-to-1 ratio uncased audio transformer. Three-inch vernier dial for condenser C1, knobs for R1 and C6, double binding-post strip, five-prong socket for plug-in coil L1, and incidental hardware and mounting screws.
- 1 steel cabinet as specified
- 1 4½-volt C battery
- 1 45-volt B battery

Three-Tube S. W. SET

THE "Fultone V" is a neat little three-tube a.c.-d.c. short-wave receiver with a magnetic loudspeaker built into the right end of its black metal case. It uses five plug-in coils to tune from 15 to 550 meters and includes tip-jacks to provide for headphone reception.

The equivalent of five-tube performance is obtained through the use of a 6F7, a 76 and a 12A7. The pentode section of the 6F7 functions as an untuned r.f. buffer stage ahead of the triode section, which is connected as a regenerative detector. Absorption effects by the antenna are thus minimized and detector regeneration is uniform over each coil's tuning range.

The 76 is a straight audio amplifier, driving the pentode section of the 12A7. The diode portion of the latter tube serves as the rectifier in the power line. The line cord contains a 350-ohm resistance element for dropping the line voltage to the proper value for series operation of the tube filaments.

The entire receiver, including the speaker, is contained in a case measuring 9½ inches long, 7 inches high and 5¾ inches deep. The chassis is formed and drilled for all the parts, and detailed assembly instructions are furnished.

The complete kit is a product of Harrison Radio Co. It contains the following parts:

- 1 chassis
- 1 cabinet with speaker grille (optional)
- 1 140 mmfd. variable condenser
- 1 vernier dial

- 1 loudspeaker
- 1 tone filter (or 750-ohm filter choke)
- 2 7-prong wafer sockets
- 1 5-prong wafer socket
- 1 4-prong coil socket
- 1 set of plug-in coils
- 1 350-ohm line cord
- 1 50,000-ohm potentiometer
- 1 switch
- 1 r.f. choke
- 1 electrolytic condenser, 12-12 mfd., 175 volts, 5-5 mfd., 35 volts
- 5 .01 mfd. condensers
- 1 .5 mfd. condenser
- 1 .0055 mfd. condenser
- 1 .002 mfd. condenser
- 2 .00015 mfd. condensers
- 1 5-meg. resistor
- 2 750,000-ohm resistors
- 1 150,000-ohm resistor
- 1 45,000-ohm resistor
- 2 40,000-ohm resistors
- 1 3000-ohm resistor
- 1 2000-ohm resistor
- 2 500-ohm resistors

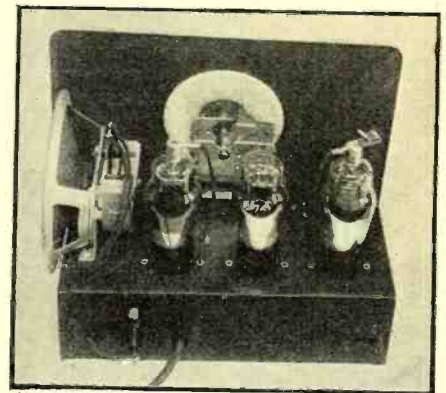

- 1 speaker twin jack
- 3 knobs
- 2 screen-grid clips
- 1 Fahnestock clip
- Assorted screws, nuts, washers and soldering lugs

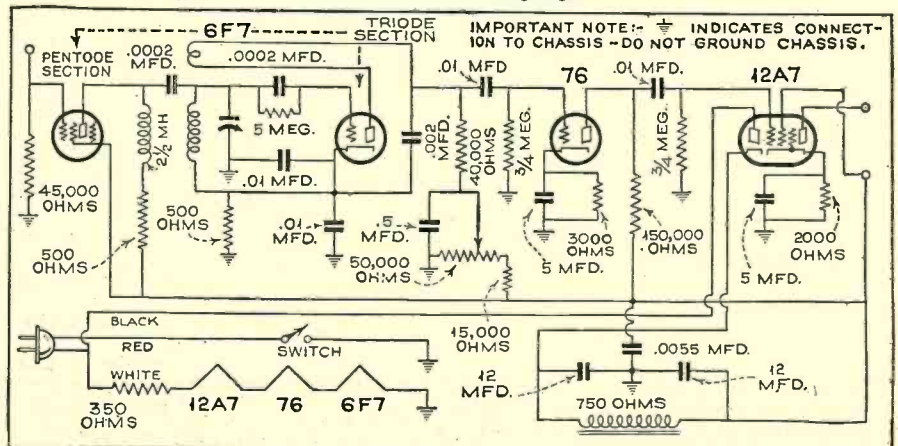

The Radio News TRAP-CIRCUIT TENATUNER

S. Gordon Taylor and John H. Potts

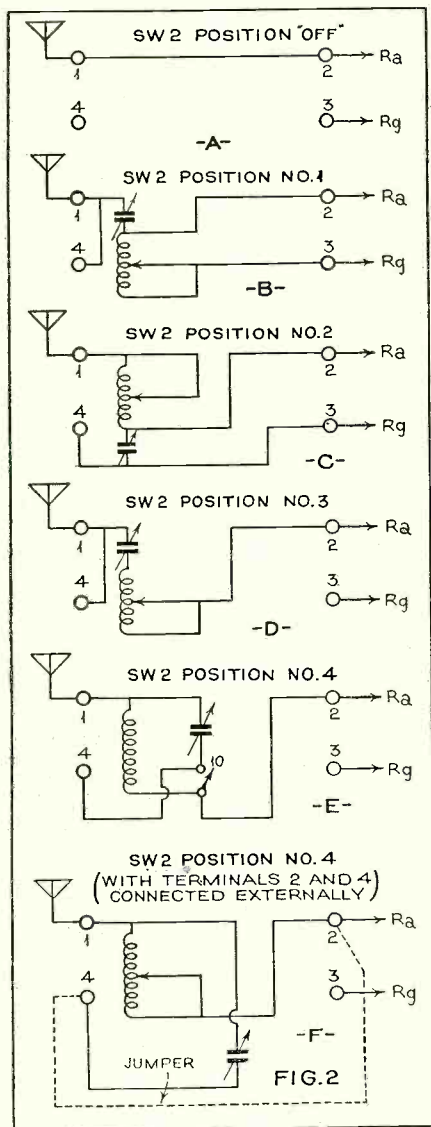
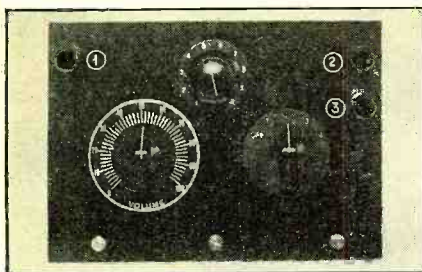

TODAY, due to the variety of input circuits employed in different receivers the design of an antenna tuner is somewhat complicated. It was because of this that a comprehensive study of this whole problem was undertaken to determine whether any antenna tuner could be worked out to function successfully with all types of present-day broadcast-band receivers. This study has resulted in the development of the "Trap-circuit Tenatuner" described in this informative and worthwhile article.

THIS unit incorporates five different circuits—three of which are antenna tuning circuits and the other two wave trap circuits, any of which is selected by a flip of the switch (SW2). One or the other of the three antenna tuning circuits has worked out successfully with every receiver with which this unit has been tried to date, except a few receivers in which the input to the first tube is of the resistance, untuned type.

A really amazing kick-up in signal voltage is obtained by tuning the antenna—as proven by actual measurements made in testing out this unit. For instance, in the RADIO NEWS Broadcast Band Listening Post in New York City, using a superheterodyne receiver equipped with means for actually measuring signal inputs, a group of stations were tuned in and their signal voltages measured with and without tuning the antenna. These measurements showed an average improvement of 820 percent in signal voltage when the antenna was tuned. In terms of decibels output this represents an average improvement of 18.3 decibels and means that a DX signal so weak as to be inaudible can be brought up to moderate loudspeaker vol-

ume through the use of this Tenatuner.

It might be said here that tuning the antenna brings up noise level as well as the signal level, but not to the same degree. A radical improvement in signal-to-noise ratio is obtainable if the receiver is equipped with tone control, because in such a case the signal is brought up to a high volume level by tuning the antenna and then the tone control is adjusted to reduce the high audio-frequency response, thus eliminating much of the noise but leaving the signal strong.

In trying out any antenna tuning system with a receiver having automatic volume control it must be remembered that so far as the ear is concerned the a.v.c. apparently tends to offset the advantage of antenna tuning. This does not mean that the antenna tuning is ineffective but only that the audio output of the increased signal is automatically reduced. In the case of very weak signals—such as are below the level at which the a.v.c. system starts to take hold—the effect of the antenna tuner will be fully appreciated. In testing an antenna tuner with a receiver of this type, therefore, it should be tested only on very weak signals. If the receiver has a tuning meter this does not hold because the increased signal input with the antenna tuner will be registered by the tuning meter.

Figure 1 shows at (B), (C), and (D) the three antenna tuning circuits of this unit. (D) is the conventional series tuned circuit while (B) and (C) are series parallel circuits. In general circuit (D) is most effective with receivers having low-impedance inputs while (B) and (C) are most successful with receivers having (Turn to page 59)

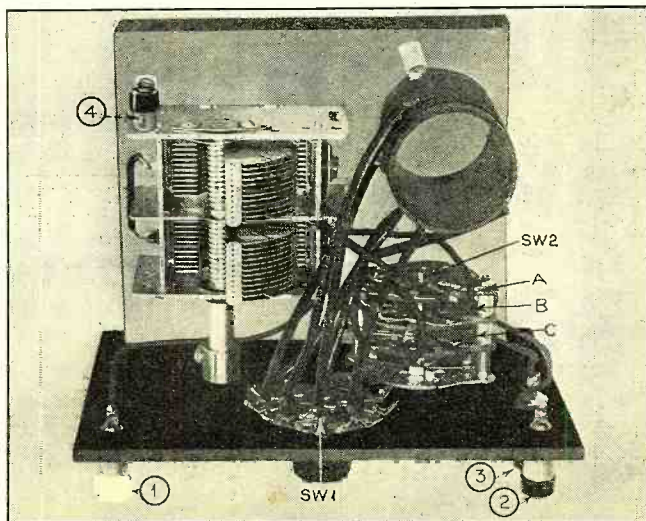
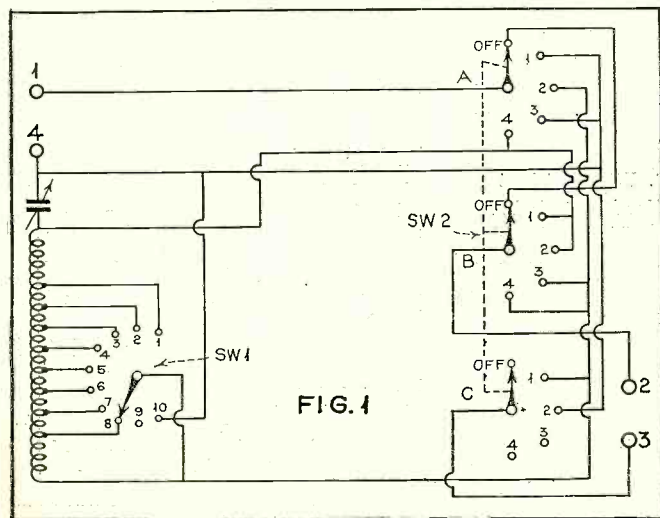

S.W. PIONEERS

Official RADIO NEWS Listening Post Observers

LISTED below by states are the Official Radio News Short-Wave Listening Post Observers who are serving conscientiously in logging stations for the DX Corner.

United States of America

Alabama, J. E. Brooks, L. T. Lee, Jr., William D. Owens; Arizona, Geo. Pasquale; Arkansas, James G. Moore, Don Pryor; California, Eugene S. Allen, A. E. Berger, C. H. Canning, Earl G. DeHaven, G. C. Gallagher, Werner Howald, Wesley W. Loudon, Robert J. McMahon, Oriente I. Noda, Geo. C. Shoin, James E. Moore, Jr., Phil E. Lockwood; Colorado, Wm. J. Vette; Connecticut, H. Kemp, Geo. A. Smith, Philip Swanson, J. Herbert Hyde; District of Columbia, Douglas S. Catehim, Phillip R. Belt; Florida, James F. Dechart, George H. Fletcher, E. M. Law; Georgia, C. H. Armstrong, Guy R. Bigbee, James L. Davis, John McCarley, R. W. Winfree; Idaho, Bernard Starr, Lawrence Swenson; Illinois, E. Bergeman, Larry Eisler, Robert Irving, Charles A. Morrison, Phillip Simmons, Samuel Tolpin, Ray A. Walters, Floyd Waters, Robert L. Weber, J. Ira Young, Evert Anderson; Indiana, Freeman C. Baiph, Arthur B. Coover, J. R. Flannigan, Henry Spearing, Iowa, J. Harold Lindblom; Kansas, C. W. Bourne, Wm. Schumacher; Kentucky, Geo. Krebs, Charles Miller, Wm. A. McAlister, James T. Spalding, W. W. Gaunt, Jr.; Louisiana, Roy W. Peyton; Maine, Danford L. Adams, M. Keith Libby, Vincent M. Wood, R. C. Messer; Maryland, Howard Adams, Jr., J. F. Fritsch, James W. Smith, August J. Walker, Forrest W. Dodge; Massachusetts, Armand A. Boussey, J. Walter Bunnell, Walter L. Chambers, Arthur Hamilton, Sydney G. Miller, Harold K. Miller, Elmer F. Orne, Roy Saunders, Donald Smith, Robert Loring Young; Michigan, Ralph B. Baldwin, Stewart R. Ruple; Minnesota, M. Mickelson, E. M. Norris, Dr. G. W. Twomey; Mississippi, Mrs. L. R. Ledbetter, Dr. E. P. Watson; Missouri, C. H. Long; Montana, Henry Dobravally; Nebraska, Hans Andersen, P. H. Clute, Harold Hansen, G. W. Renish, Jr.; Nevada, Don H. Townsend, Jr.; New Hampshire, Paul C. Atwood, Alfred J. Mannix; New Jersey, Wm. F. Buhl, Wm. Dixon, Morgan Foshay, George Munz, R. H. Schiller, Paul B. Silver, Earl R. Wickham; New Mexico, G. K. Harrison; New York, Donald E. Bame, John M. Borst, H. S. Bradley, Wm. C. Dorf, Ray Geiss, Capt. Horace L. Hall, Robert F. Kaiser, John C. Kalmbach, Jr., I. H. Kattell, W. B. Kinzel, Wm. Koehlein, T. J. Knapp, G. J. Leonhardt, Joseph M. Malast, S. Gordon Taylor, Edmore Melanson, Joseph H. Miller, R. Wright, Harry E. Kentzel, Howard T. Neupert; North Carolina, W. C. Couch, E. Payson Mallard, H. O. Murdoch, Jr.; Ohio, Paul Byrns, Charles Dooley, Stan Elcheshen, Albert E. Emerson, Samuel J. Emerson, R. W. Evans, Clarence D. Hall, William Oker, Donald W. Shields, C. H. Skatzes, Carl P. Peters, Orval Dickes; Oklahoma, H. L. Pribble, Robert Woods, W. H. Boatman; Oregon, Harold H. Flick, Geo. R. Johnson, James Haley, Ernest R. Remster, Ned Smith, Virgil C. Tramp; Pennsylvania, Oliver Amlic, Harold W. Bower, Roy L. Christoph, R. O. Lamb, John Leininger, Geo. Liley, Edward C. Lips, Chas. Nick, Hen. F. Polm, C. T. Sheaks, K. A. Staats, F. L. Stitzinger, Walter W. Winand; Rhode Island, Carl Schradeck, Joseph V. Trzuskowski; South Carolina, Edward Bahan, Ben F. Goodlett; South Dakota, Paul J. Mraz; Tennessee, Chas. D. Moss, Eugene T. Musser; Texas, James Brown, Heinie Johnson, Carl Sherz, Bryan Scott, James W. Sheppard, John Steward, Overton Wilson; Utah, Earl Larson, Harold D. Nordeen, A. D. Ross; Vermont, Eddie H. Davenport, Jos. M. Kelley, Dr. Alan E. Smith; Virginia, G. Hampton Allison, L. P. Morgan, D. W. Parsons, Gordon L. Rich, Gaines Hughes, Jr.; Washington, Glenn E. Dubbe, A. D. Golden, Charles G. Payne; West Virginia, Kenneth R. Boord, R. E. Sumner; Wisconsin, Willard Hardell, Walter A. Jasiorowski; Wyoming, L. M. Jensen, Dr. F. C. Naegeli.

Applications for Official Observers in the remaining States should be sent in immediately to the DX Corner.

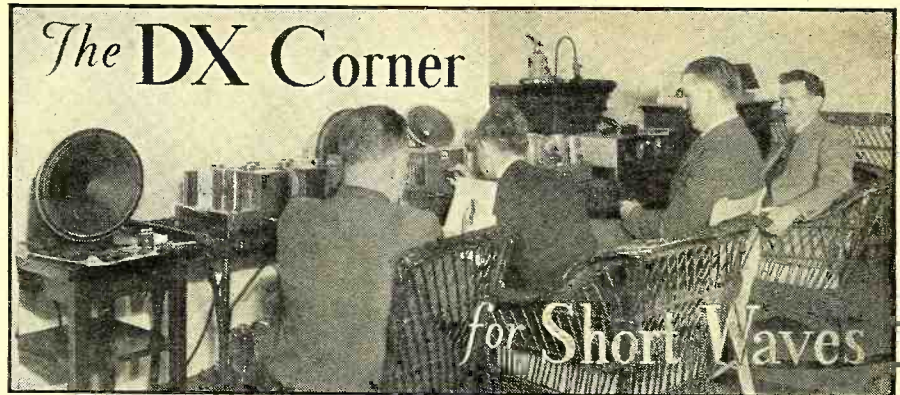

S. W. TIME SCHEDULE

LAURENCE M. COCKADAY

THE twenty-eighth installment of the DX Corner for Short Waves contains the World Short-Wave Time-Table for 24-hour use all over the world. The list starts at 01 G.M.T. and runs 24 hours through 00 G.M.T., right around the clock! This Time-Table contains a List of Short-Wave Stations, logged during the last month in the RADIO NEWS Westchester Listening Post (in our Editor's home), as well as at our official RADIO NEWS Short-Wave Listening Posts throughout the world. It provides an hour-to-hour guide to short-wave fans, whether experienced or inexperienced. The Time-Table shows the Call Letters, Station Locations, Wavelength and Frequency in the middle column. The column at the left gives the Times of Transmission in G.M.T. a.m., and the column at the right gives the Times of Transmission in G.M.T. p.m. The corresponding time in E.S.T. is also given and space has been left for filling in your own Local Time. The time, E.S.T., in the U. S. would be 8 p.m., E.S.T., for 01 G.M.T., as there is a five-hour difference. The time, E.S.T., for 13 G.M.T. would, therefore, be 8 a.m., E.S.T. These two features can be seen at the beginning of each outside column in the Time-Table. The times, C.S.T., for these two corresponding hours would be 7 p.m., C.S.T., and 7 a.m., C.S.T. The times, M.S.T., for the corresponding hours would be 6 p.m., M.S.T., and 6 a.m., M.S.T. The times, P.S.T., for corresponding hours would be 5 p.m. and 5 a.m., P.S.T. In this way American listeners can easily fill in their own Local Times at the top of the columns. Foreign listeners would probably prefer to use G.M.T., anyway, or, if not, can compute the time difference from G.M.T. and fill in their Local Time in each column head. At the end of the Time-Table is given a List of Symbols covering the various irregularities of transmission, etc.

APPOINTED L.P.O. FOR MAINE

Here is Vincent M. Wood and his DX Corner. His home town is Bangor.

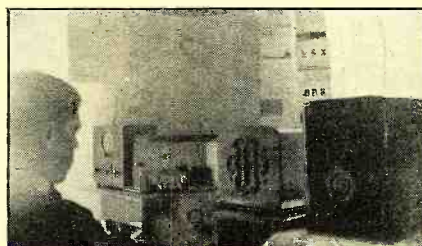

Affiliated DX Clubs

We are hereby placing a standing invitation to reliable DX Clubs to become affiliated with the DX Corner as Associate Members, acting as advisers on short-wave activities, in promoting short-wave popularity and reception efficiency. A list of associate organizations follows: International DX'ers Alliance, President, Charles A. Morrison; Newark News Radio Club, Irving R. Potts, President, A. W. Oppel, Executive Secretary; Society of Wireless Pioneers, M. Mickelson, Vice-President; U. S. Radio DX Club, Geo. E. Deering, Jr., President; the Radio Club Venezolano of Caracas, Venezuela, President, Alberto Lopez; The World-wide Dial Club of Chicago, Illinois, President, Howard A. Olson.

Any DX fan wishing to join any one of these Clubs or Associations may write for information to the Short-Wave DX Editor, and his letter will be sent to the organization in question. Other Clubs who wish to become affiliated should make their application to the Short-Wave DX Editor. Clubs associated with the DX Corner have the privilege of sending in Club Notes for publication in RADIO NEWS.

Your DX Logs Welcome

Please keep on sending in your information on any s.w. stations that you hear during the coming month, getting them in to the short-wave DX Editor by the 20th of the month. In this way you share your "Best Catches" with other readers and they, in turn, share with you, making for improved knowledge on short-wave reception. Also send in any corrections or additions that you can make to the short-wave identification charts, including station addresses, station slogans, station announcements, and any identifying signals the stations may have. Our Editors are doing the same thing, working with you day and night to bring you the best and most reliable short-wave information. Your logs are welcome and are sincerely invited.

Let's See Your DX Corner!

Readers are also invited to send in photographs or snapshots of themselves in their Listening Posts, for publication in the DX Corner. Let other readers see what you and your equipment look like! RADIO NEWS will pay \$1.00 for each photo used, to help defray expenses. If a copy of RADIO NEWS appears in the photo, this payment will be doubled.

Listening Post Observers and Other Fans Please Notice

Listed on next page is this month's partial information regarding short-wave sta-

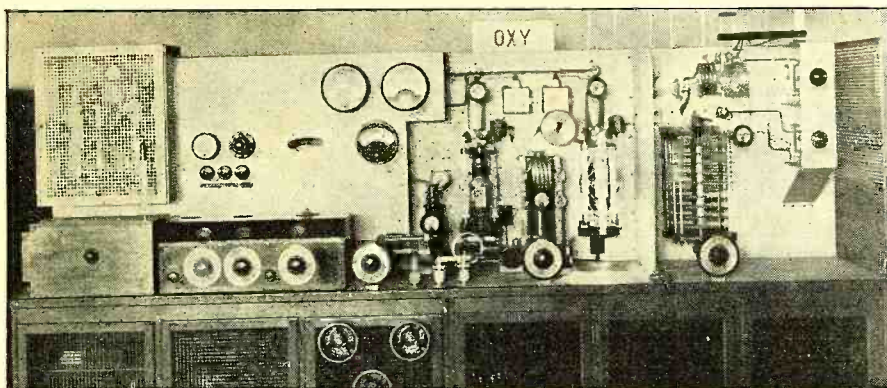

FAMOUS DANISH STATION AT SKAMLEBAEK

Short-wave programs from Copenhagen are transmitted through Station OXY, the equipment of which is shown above. The program schedules are given in the Time-Table.

tions, heard and reported by our World-Wide Listening Posts. Each item in the listing is credited with the Observer's surname. This will allow our readers to note who obtained the information given. If any of our readers can supply actual Time Schedules, actual Wavelengths, correct Frequencies, or any other Important Information regarding these items, the DX Corner Editor and its readers will be glad to get the information. There are some hard stations to pull in in these listings, but we urge our Listening Posts and other readers to try their skill in logging the stations and getting correct information about them. When you are satisfied that you have this information correct, send it in to the editor; or if you have received a "veri" from any of the hard-to-get stations, send in a copy of the "veri" so that the whole short-wave fraternity may benefit. The list follows:

HP5J, Panama City, Panama, 31.3 meters, 9590 kc., 7-9 pm., E.S.T. (Powers, Peters, Wickham, D. Adams, Lindblom, Musser, Krier, Healy, Bower, Gallagher, Reilly, Alan Smith.)

XECR, Mexico City, Mexico (reported incorrectly last month as XEPR), 40.5 meters, 7380 kc., 6-7 p.m., E.S.T. (some reports say Sundays, some daily). (Doty, Jr., Johnson, Wilson, J. H. Miller, Covington, Whitehair, Gomez, Puhler.)

HJ4ABA, Medellin, Colombia, reported variously on 11,720 kc., 11,710 kc., 11,715 kc., 11,711 kc., but which is probably 11,720 kc., 6-10:30 pm., E.S.T. (Jordan, Amlie, Swartley, Kintzel, Marshall, Doty, Jr., Stabler, Bower, Atkinson, Koehnlein Schumacher Wojtkeiwic, Hamilton.)

HJ3ABH, Bogota, Colombia, reported by some as an amateur broadcaster, 49.8 meters, 6018 kc., 7-11 p.m., E.S.T. (Puhler, Chambers, Foshay, Hamilton, Young, Libby, Gallagher Johnson.)

HJ4ABL, Manizales, Colombia, reported variously as 6065 kc., 6005 kc., 6100 kc. (last one correct), 5:30-7:30 p.m., 10:30-11:30 p.m. and 11:30 p.m.-12 m. This last half-hour is a DX broadcast and letters are read from short-wave fans (there is no station HJ4ABN). (Christoph, J. G. M., Winfree, Eisler, Moore.)

FYA, Pontoise, France (what's this—a harmonic or an image-frequency?), on about 9550 kc., 5:30-7 p.m., E.S.T. (Edkins.)

HJ4ABE, Medellin, Colombia, 50.6 meters, reported variously on 5860 kc., 5950 kc. and 5930 kc. (5930 kc. is prob-

ably the right one), 7:30-9 p.m., with a DX program at 11 p.m. Mondays. (Baldwin, Coover, Munz, Krier, Foshay, Christoph.)

HJ5ABD, Cali, Colombia, 42.6 meters, 6490 kc., Mondays, Tuesdays, Wednesdays and Fridays, 7-10:30 p.m. (Foshay.)

VK5ME, Melbourne, Australia, 31.5 meters, 9510 kc., now on the air Wednesdays, Thursdays, Fridays and Saturdays, 5-7 a.m. (Wickham, Amlie.)

HJ1ABG, Barranquilla, Colombia, 49.65 meters, 6042 kc., 12-1 p.m., 6-10 p.m., E.S.T., for all days except Sundays. On Sundays it is on the air from 1-6 p.m., E.S.T. (Foshay.)

Bagdad, Iraq will soon be conducting tests on the air on 49 meters. (Kouyoundjian.)

HJ1ABE, Cartagena, Colombia, reported variously on 6115 kc., 6015 kc., 6130 kc., 6120 kc., 6150 kc. (correct frequency believed to be 6120 kc.), on the air from 7-9 p.m. and from 10:30 to 11 p.m. Mondays for DX broadcast and occasionally 11:30 a.m. to 1 p.m. (Duncan, Sholin, Bower, Adams, Pilgrim.)

HC2JSB, Guayaquil, Ecuador, reported on 39 meters, 7700 kc., 9-11 p.m., except Sundays and Mondays. (Powers.)

HJ1ABD, Cartagena, Colombia, is now on 41.1 meters, 7281 kc. (Dobrovolny, Donaldson, Schumacher.)

HJ4ABB, Manizales, Colombia, reported testing on a new wavelength of 49.1 meters, 7-9 p.m.

HJ1ABA, reported on 6100 kc.
YV5RMO, Maracaibo, Venezuela, reported by many listeners on 25 meters, 11,720 kc. (This seems to be an exact harmonic of their 51-meter wave.) Can anyone check this?

While we are on the subject of South America, let us state that the whole situation seems to be rather a mix-up, so many changes and variable reports. We urge our LPO's to get verifications of wavelength frequencies and time schedules wherever possible and send in this data immediately stating source. The following are some "HJ" calls about which there seems to be no agreement as

(Turn to page 20)

OUR L.P.O. IN NEW YORK
Introducing Joseph H. Miller, O.R.N.S.W.
L.P.O. for New York, shown in his DX
Corner. He uses a National receiver and
says: "I have been doing some wonderful
DXing with this little thrill box."

S.W. PIONEERS
Official RADIO NEWS Listen-
ing Post Observers

LISTED below by countries are the Official RADIO NEWS Short-Wave Listening Post Observers who are serving conscientiously in logging stations for the DX Corner.

- Alaska, Thomas A. Pugh.
 - Argentina, J. F. Edbrooke.
 - Australia, Albert E. Faull, A. H. Garth, H. Arthur Matthews, C. N. H. Richardson, R. H. Tucker.
 - Belgium, Rene Arickx.
 - Bermuda, Thursten Clarke.
 - Brazil, W. W. Enete, Louis Rogers Gray.
 - British Guiana, E. S. Christiani, Jr.
 - British West Indies, E. G. Derrick, Edela Rosa, N. Hood-Daniel.
 - Canada, J. T. Atkinson, A. B. Baadsgaard, Jack Bews, Robert Edkins, W. H. Fraser, Fred C. Hickson, C. Holmes, John E. Moore, Charles E. Roy, Douglas Wood, Claude A. Dulmage.
 - Canal Zone, Bertram Baker.
 - Canary Islands, Manuel Davin.
 - Central America, R. Wilder Tatum.
 - Chile, Jorge Izquierdo.
 - China, Baron Von Huene.
 - Colombia, J. D. Lowe, Italo Amore.
 - Cuba, Frank H. Kydd, Dr. Evelio Villar.
 - Czechoslovakia, Ferry Friedl.
 - Denmark, Hans W. Priwin.
 - Dominican Republic, Jose Perez.
 - Dutch East Indies, E. M. O. Godee, A. den Breeins, J. H. A. Hardeman.
 - Dutch West Indies, R. J. van Ommersen.
 - England, N. C. Smith, H. O. Graham, Alan Barber, Donald Burns, Leslie H. Colburn, Frederick W. Cable, C. L. Davies, Frederick W. Gunn, R. S. Houghton, W. P. Kempster, R. Lawton, John J. Maling, Norman Nattall, L. H. Plunkett-Checkemain, Harold J. Self, R. Stevens, L. C. Styles, C. L. Wright, John Gordon Hampshire, J. Douglas Buckley, C. K. McConnon, Fred C. Hickson, Douglas Thwaites, J. Rowson, A. J. Webb.
 - France, J. C. Meillon, Jr., Alfred Quagliano.
 - Germany, Herbert Lennartz.
 - Hawaii, O. F. Sternemann.
 - India, D. R. D. Wadia.
 - Irish Free State, Ron. C. Bradley.
 - Iraq, Hagop Kouyoundjian.
 - Italy, A. Passini, Dr. Guglielmo Tixy.
 - Japan, Massall Satow.
 - Malta, Edgar J. Vassallo.
 - Mexico, Felipe L. Saldana, Manuel Ortiz Gomez.
 - New Zealand, Dr. G. Campbell Macdiarmid, Kenneth H. Moffatt.
 - Norway, Per Torp.
 - Philippine Islands, Victorino Leonen.
 - Portugal, Jose Fernandes Patrae, Jr.
 - Puerto Rico, Manuel F. Betances.
 - Scotland, Duncan T. Donaldson.
 - South Africa, Mike Kruger, A. C. Lyell, H. Mallet-Veale.
 - Spain, Jose Ma. Maranges.
 - Sweden, B. Scheierman.
 - Switzerland, Dr. Max Hausdorff, Ed. J. DeLopez.
 - Turkey, Herman Freiss, M. Seyfeddin.
 - Venezuela, Francisco Fossa Anderson.
- Applications for Official Observers in the remaining countries should be sent in immediately to the DX Corner.



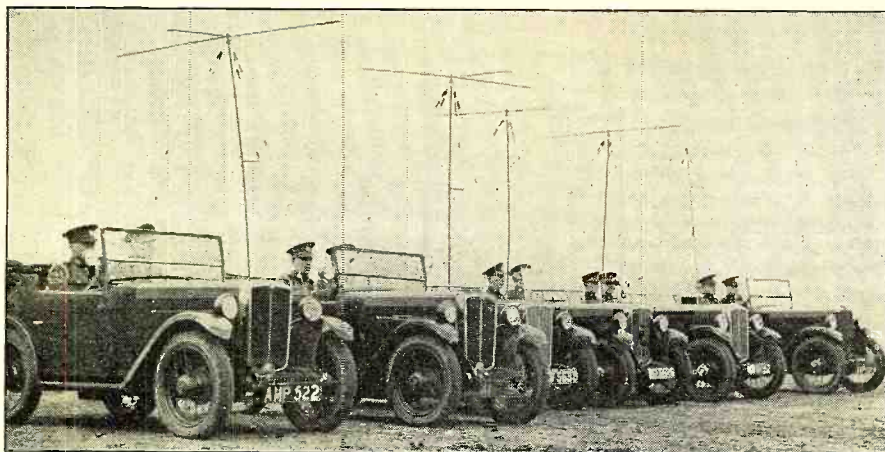

The DX Corner (Short Waves)

(Continued from page 17)

to frequency or schedule: **HJ5ABE**, Cali; **HJ3ABF**, Popayan; **HJ5ABG**, Cali; **HJ5ABB**, Cali; **HJ5ABH**, Palmira; **HJ4ABN**, Manizales; **HJ4ABF**, Medellin; **HJ4ABG**, Medellin; **HJ4ABC**, Periera?; **Quibdo?**; **HJ4ABD**, Medellin; **HJ4ABI**, Medellin; **HJ1ABH**, Santa Marta; **HJ1ABJ**, Santa Marta; **HJ1ABK**, Barranquilla; **HJ3ABC**, Bogota; **HJ3ABI**, Bogota. These calls were furnished through U. S. Radio DX Clubs and the IDA and other tip-sheets, but no agreements could be found on the correct data.

XICZ, Vera Cruz, Mexico, reported heard on about 7120 kc., 9 p.m. (Peters.)

PRADO, reported now on the air from 9-11:45 p.m., E.S.T., the last 15 minutes given to answering best reports received. (Olsen, Jr.)

The summer concerts from **PRADO** are scheduled to start again on 15,440 kc. during the month of May, to last all summer. Last year the program was on Sunday from 3-7 p.m., E.S.T.

HKV, Bogota, Colombia, reported on 8795 kc. (Swartley, Baldwin.)

CNR, Rabat, Morocco, reported

MEET OBSERVER HYDE

Our organization of Listening Post Observers welcomes J. Herbert Hyde of Elmwood, Connecticut, into its growing ranks of short-wave pioneers.



RADIO UNITS ON REVIEW

One of the features of last month's programs on the short waves was the British Empire Jubilee programs. The illustration shows a motorcar military radio unit engaged in a dress rehearsal for the review.

heard the first time lately with R6 volume by Elcheshen.

YV9RC, Caracas, Venezuela, will soon be on the air on 6400 kc., according to a late report. Listen for them and get schedules.

HJ2ABD, Bacaranga, Colombia, reported heard testing on 5970 kc., 9-10:30 p.m. (Schumacher.)

JVM and **JVN**, the Nazaki twins on 10,740 and 10,660 kc., respectively, are now the best received stations at the Listening Post (Westchester Post).

JVQ, Nazaki, on 7470 kc., reported heard at 8 a.m., E.S.T. (Schumacher.)

KZG, reported heard on 47.39 meters, 6330 kc., heard about 6:30 a.m., E.S.T. (Sholin, J. H. Miller, Gallagher.)

JVF, Nazaki, Japan, 19.2 meters, 15,620 kc., reported heard regularly 3:30 to 5 p.m. (Howald, Craft, Moore, Powers.)

JVV, Nazaki, Japan, reported heard on 5.72 megacycles at approximately 3-4 a.m., E.S.T. (Pryor.)

XGW, Shanghai, China, 34.3 meters, 8750 kc., reported heard 6-9 a.m., E.S.T. (Craft.)

XGOY, Shanghai, China, 31.3 meters, 9580 kc., reported heard 2-4 a.m., E.S.T. (Craft.)

VIZ3, Australia, reported heard on about 25.9 meters, 11.5 megacycles. (J. H. Miller.)

ZHI, Singapore, 49.09 meters, 180 watts, reported on the air Mon., Wed. and Thurs., 6:30-9 a.m., on Sundays 12:30-2 a.m., and on every other Sunday 6-7 a.m. All times E.S.T. (Amlic.)

TIRCC, San Jose de Costa Rica, soon to be on the air from 12-2 p.m.; frequency not known. (Palacio.)

T12TG, San Jose de Costa Rica, 6550 kc. (A. E. Emerson.)

TIPG, San Jose de Costa Rica, reported on 6550 kc., also on 7150 kc. (Hall.)

TICW, Puerto Limon de Costa Rica, 40 meters, 12-2 p.m. (Palacio.)

A PRESIDENT LOOKS AT RADIO

General Carmona, President of the Republic of Portugal, recently paid a visit to Luiz Cardoso of Lisbon to inquire about a Pilot short-wave receiver. He showed great interest in short-wave activities.

CLUB

Society of Wireless Pioneers

W9QJ will be the official station of the SWP and it is planned to increase its input to 1 kw. by the latter part of the summer. W9QJ transmits on 7100 kc. CW.

On May 4th W9QJ transmitted a message to King George V of England and his Queen on behalf of the entire SWP membership on the occasion of the 25th year of his reign and his birthday.

Brother Claude Sweeney has placed an exceptionally fine ribbon mike on the market and one of them is used on the stage of the Municipal Auditorium here in Minneapolis. (A description of same by Sweeney is enclosed herewith.)

Due to rapidly failing eyesight, Richard Leslie Rawles, our Honorable Director of European Publicity, has resigned his post effective immediately and Mr. Geoffrey Cutts, B.Sc. of 75 Broomhall Street, Sheffield 3, has been chosen to succeed him. It is with deep regret that we make the an-



OUR DIRECTOR FOR FRANCE

The Vicomte Jean de La Brosse shown with some of his radio transmitting apparatus and representing the Society in France.

TIFE, San Jose de Costa Rica, reported heard 10 p.m., E.S.T. (Scherz.)

T15HH, La Vox de San Ramon, Costa, Rica 42 meters reported heard at 12 noon and also 4-8 p.m. E.S.T. (Palacio.)

TIGPH, San Jose de Costa Rica, 45.6 meters, 6570 kc., 8-12 midnight, E.S.T. (Craft.)

TIBA, Guatemala City, Guatemala,



NEWS

Radio News Official Organ

nouncement of Brother Rawles' retirement as he has been with us since the inauguration of the Society. However, Brother Rawles informs us that his successor is well qualified to take up where he left off and gives him a mighty fine recommendation.

Sister Alice R. Bourke, W9DXX, trekked to Americus, Georgia, the early part of April and took one stage of her rig along. Sez that DX is not so hot down that way. Had a wonderful trip.

Brother D. R. D. Wadia of Bombay, India, our Director of Asiatic Affairs, is making an extensive European trip and no doubt several of the Brothers will receive him as a guest.

Brother Wadia was a guest at the Polish Consulate in Bombay recently at a dance and concert of Polish music.

For that FB mixer for your den or the OL's skullery, get yourself an old auto horn motor, a bit of shafting and a coupler. Then swipe the baby's toy transformer for a control and you have a mixer which serves the purpose as well as the best of them.

Realizing that "in unity there is strength," much interest is being shown in the formation of amateur radiophone organizations. Already active and functioning are the New England Fone Assn., Lt. Col. Davis S. Boyden, W1SL, pres.; the Atlantic Division Radiofone Assn., Dr. Burton T. Simpson, W8CPC, pres.; the West Gulf Radiofone Assn., Millard Walker, W5AHK, pres., and the Canadian Radiofone Assn., Milton Cole, VE3II, pres. Associations in Central, Delta and Midwest districts are expected to join the list shortly.

HEARD THIS ONE?

Have you been lucky enough to pull in short-wave Station CR6AA, at Lobito, Angola, Portuguese West Africa?



14.7 megacycles, reported heard 6 p.m., E.S.T. (Walters.)

TI5JJ, San Jose de Costa Rica, 6.57 megacycles, 8-10:30 p.m., E.S.T. (McMahon.)

L. P. O. Moore tells us that station KGGC carries a program of the Wide World Radio Club on Saturday nights, 1:15 a.m., on 1420 kc., with information on Far Eastern and other short-wave stations.

CR7AA, Lorenzo Marques, Africa, reported transmitting on Mon., Thurs. and Sat., 8:20-10:30 p.m., South African time. (Kruger.)

"Poste Parisien" reported on 43.75 meters. (Webb.)

L.P.O. Baadsgaard of Ponoka, Canada, reported receiving veri from OPM, Leopoldville, Belgian Congo, 29.59 meters, 10140 kc., on air between 9:30-22, G.M.T. He also reports two veris from SUV, Cairo, Egypt.

VP1A, Suva, Fiji Islands, is now on 28.7 meters. Reported on the air from 3-4 p.m., E.S.T. (Baadsgaard.)

PKYDA2, Bandoeng, Java, reported now on 6120 kc., 5:30-10 a.m., on Fridays and to 11:30 a.m., E.S.T., on Saturdays and Sundays. (McMahon.)

ZSS, Klipheuvcl, South Africa, reported heard 15.83 meters, 12:30-1 p.m., E.S.T. (Baadsgaard.)

SUZ, Cairo, Egypt, 26 meters, 11.99 megacycles, reported heard 12:30 p.m., E.S.T. (Getz.)

JB is the correct call for ZTJ. (ZTJ is long-wave call of this station.)

KKP Kahuku, Hawaii, 16030 kc., heard rebroadcasting programs at 11:30 p.m., E.S.T. (Schumacher.)

HI3C, La Vox del Rio, Dulce, La Romana, D. R., is a commercial station working daily from 12:30 to 2 p.m., and on Saturdays 12-2 a.m.,

ANOTHER MAINE L.P.O.

R. C. Messer is welcomed as our new L.P.O. His home is South Portland and he is a member of the I.D.A.

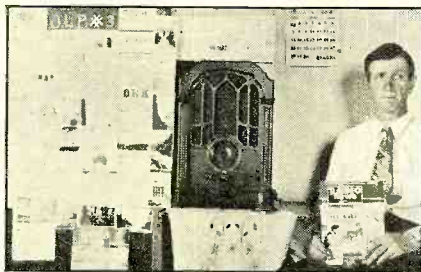

HE PULLS 'EM IN

Kenneth Dressler has been very successful, lately, in pulling in distant stations and sending in his reports to the DX Corner for Short Waves. He is shown at his RCA 240.

E.S.T. Its frequency is 43 meters, 6900 kc., 15 watts. (R. P. Bernard, owner.)

HCJB, Quito, Ecuador, reported now on 36.5 meters, 12:30-1 a.m., E.S.T. (Kintzell.)

HI4D, San Domingo, D. R., is reported to be on 45.7 meters instead of 46.2 meters. Who can check this? (Libby.)

HIL, San Domingo, D. R., 6500 kc., reported on the air 11:30 p.m., E.S.T. (Schumacher.)

HJ4ABJ, Sincelejo, Colombia, 7700 kc., reported heard 10-11:00 pm., E.S.T. (Schumacher.)

YNIGG, Managua, Nicaragua, reported irregularly from 7 p.m. to 1 a.m., E.S.T., daily. Another report says on the air from 1-3 a.m., at times. (Villar, Swartley.) (Turn to page 54)

BARBADOS, VP6YP CALLING

Here is Thomas A. Archer and his amateur station in the British West Indies, reported as broadcasting a series of English cricket matches. He says he is no longer on the air for broadcasting but is back on the amateur band, 14312 kc.



SHORT-WAVE STATION LIST

(Wavelength, Frequency, Call, Location, Power and Service)

All Time is Eastern Standard Time

Meters	Kc	Call	Location	Kw	Service, etc.	Meters	Kc	Call	Location	Kw	Service, etc.
10.06	29,817	IAF	Fiumicino, Italy	5.0	Exp.	17.33	17,300	W6XAJ	Oakland, Calif.	...	Exp.
13.45	22,291	GBU	Rugby, England	...	Phone	17.33	17,300	W8XL	Dayton, Ohio	...	Exp.
13.91	21,550	XGBA	Shanghai, China	18.5	Broadcast	17.33	17,300	W2XCU	Ampere, N. J.	...	Exp.
13.92	21,540	VK3LR	Lynchurst, Australia	...	Broadcast	17.33	17,300	VE9BY	London, Ont., Canada	...	Exp.; irr.
13.92	21,540	WBXX	Pittsburgh, Pa.	40.0	Broadcast; relays	17.37	17,260	DAF	Norddeich, Germany	5.0	Phone; 9:15 a. m., irr.
13.93	21,530	GSJ	Daventry, England	15.0	Broadcast	17.50	17,122	HAS5	Székesszék, Hungary	...	Broadcast
13.96	21,470	GSH	Daventry, England	15.0	Broadcast	17.51	17,110	WOO	Ocean Gate, N. J.	20.0	Phone
14.00	21,420	W2XDJ	Deal, N. J.	...	Exp.	17.55	17,080	GBC	Rugby, England	5.0	Phone
14.00	21,420	WKX	Lawrenceville, N. J.	20.0	Phone to LSN	18.06	16,665	DAN	Norddeich, Germany	...	Tests with ships
14.00	21,420	WLO	Lawrence, N. J.	...	Transatlantic phone	18.36	16,330	VLK-			
14.19	21,140	KBI	Manila, P. I.	10.0	Phone	18.39	16,300	PCL	Sydney, Australia	3.5	Phone
14.24	21,060	WKA	Lawrenceville, N. J.	20.0	Phone to England	18.43	16,270	WLK	Kootwijk, Holland	...	Phone to Bandoeng
14.24	21,060	KWN	Dixon, Calif.	20.0	Phone	18.47	16,240	KTO	Lawrenceville, N. J.	20.0	Phone to England
14.27	21,020	LSN	Buenos Aires, Argentine	...	Phone to WLO, 8 a. m.; 4 p. m.	18.49	16,214	FZR3	Manila, P. I.	40.0	Phone
14.27	21,020	OKI	Podebrady, Czechoslovakia	...	Phone	18.54	16,162	PSA	Saigon, French Indo China	15.0	Phone
14.37	20,860	EBY	Madrid, Spain	7.5	Phone to Buenos Aires	18.55	16,150	GBX	Rio de Janeiro, Brazil	...	Broadcast
14.40	20,820	KSS	Bolinas, Calif.	40.0	Phone	18.70	16,030	KKP	Rugby, England	...	Phone to VK2ME, 4-11 p. m.
14.43	20,780	KMM	Bolinas, Calif.	40.0	Phone	18.77	15,985	KQH	Kahuku, Hawaii	40.0	Phone to KWO, 2-7 p. m.
14.48	20,700	LSY	Buenos Aires, Arg.	10.0	Phone	18.80	15,950	PLG	Bandoeng, Java	...	Phone; afternoons
14.49	20,680	LSX	Buenos Aires, Arg.	...	Phone to USA	18.88	15,880	FTK	Ste. Assise, France	30.0	Phone to Saigon
14.49	20,680	LSN	Buenos Aires, Arg.	...	Phone to Europe after 10:30 p. m.	18.91	15,855	CEC	Santiago, Chile	0.8	Phone
14.57	20,580	PMB	Bandoeng, Java	60.0	Phone to PCK	19.03	15,760	JYT	Kemikawa-Cho, Japan	5.0	Relay broadcast and tests
14.71	20,380	GBA	Rugby, England	15.0	Phone to ships and LSN	19.14	15,670	LSF	Buenos Aires, Arg.	...	Phone
14.88	20,140	DWG	Nauen, Germany	...	Phone to LSG	19.15	15,660	JVE	Nazaki, Japan	...	Phone; occasional broadcast
14.96	20,040	OPL	Leopoldville, Belgian Congo	...	Phone to ORG, morn.	19.20	15,620	JES	Osaki, Japan	...	Phone; sometimes broadcast
14.97	20,028	DHO	Nauen, Germany	7.2	Phone	19.20	15,620	JVF	Nazaki, Japan	...	Phone; sometimes bc.
15.01	19,980	KAX	Manila, P. I.	20.0	Phone to Dixon	19.25	15,490	KEM	Bolinas, Calif.	40.0	Phone
15.03	19,950	DIH	Nauen, Germany	7.0	Phone to France	19.37	15,475	KKL	Bolinas, Calif.	40.0	Phone
15.07	19,900	LSG	Buenos Aires, Arg.	...	Phone	19.39	15,460	KKR	Bolinas, Calif.	40.0	Phone
15.10	19,850	WMI	Deal, N. J.	...	Phone	19.40	15,454	...	Pontoise, France	...	Phone; 7-11 a. m.
15.12	19,850	FTD	Ste Assise, France	...	Phone	19.42	15,440	PRADO	Riobamba, Ecuador	...	Phone
15.13	19,820	WKN	Lawrenceville, N. J.	20.0	Phone to England, 8 a. m.—4 p. m.	19.43	15,430	KWE	Bolinas, Calif.	40.0	Phone
15.21	19,720	EAQ	Madrid, Spain	10.0	Phone to Latin Am.	19.45	15,410	KWO	Dixon, Calif.	20.0	Phone to Hawaii, 2-7 p. m.
15.23	19,650	CEC	Santiago, Chile	4.0	Phone to LSR, HJY	19.51	15,370	HAS3	Budapest, Hungary	20.0	Broadcast
15.49	19,345	PMA	Bandoeng, Java	40.0	Phone, sometimes broadcast	19.54	15,355	KWU	Dixon, Calif.	20.0	Phone to Hawaii, 2-7 p. m.
15.57	19,260	PPU	Rio de Janeiro, Brazil	13.5	Phone to France	19.55	15,340	CT1AA	Lisbon, Portugal	...	Broadcast
15.58	19,240	DFA	Nauen, Germany	...	Phone to XDA	19.55	15,340	DJR	Zeesen, Germany	50.0	Testing
15.60	19,220	WKF	Lawrenceville, N. J.	20.0	Phone to England	19.56	15,330	W2XAD	Schenectady, N. Y.	20.0	Be.; relays WGY
15.61	19,200	ORG	Ruyssedele, Belgium	8.0	Phone	19.60	15,300	CE7	La Paz, Bolivia	1.0	Phone
15.74	19,050	JVC	Nazaki, Japan	...	Phone, sometimes broadcast	19.60	15,300	OXY	Skamlebek, Denmark	...	Exp.
15.76	19,020	WKW- W2XBJ	Rocky Pt., N. Y.	...	Tests; mornings	19.62	15,280	DJQ	Zeesen, Germany	50.0	Broadcast
15.87	18,892	WDS	Rocky Pt., N. Y.	...	Phone	19.64	15,270	W2XE	Wayne, N. J.	15.0	Broadcast
15.87	18,890	ZSS	Klippevlei, S. Africa	5.0	Phone to GAA	19.65	15,260	GSJ	Daventry, England	...	Broadcast
15.92	18,830	PCE	Bandoeng, Java	60.0	Phone to Dixon, Calif.	19.67	15,250	W1XAL	Boston, Mass.	5.0	Broadcast
16.05	18,680	OCI	Lima, Peru	...	Phone	19.67	15,243	FYA	Pontoise, France	12.0	Broadcast
16.10	18,620	GBJ	Bodmin, Eng.	...	Phone to Montreal	19.70	15,220	PCJ	Eindhoven, Holland	12.0	Exp.
16.10	18,620	GAU	Rugby, England	15.0	Phone to WMI, 6 a. m.—2 p. m.	19.72	15,210	W8XK	Pittsburgh, Pa.	40.0	Be.; relays KDKA
16.12	18,600	PDM	Kootwijk, Holland	...	Phone	19.72	15,200	DJB	Zeesen, Germany	5.0	Broadcast
16.27	18,440	HJY	Bogota, Colombia	...	Phone CEC, LSR	19.80	15,140	GSF	Daventry, England	15.0	Broadcast
16.18	18,535	PCM	Kootwijk, Holland	...	Phone	19.82	15,130	VK9DN	Montreal, Que.	...	Broadcast
16.29	18,400	PKK	Kootwijk, Holland	...	Phone	19.83	15,123	HVJ	Rome, Italy	10.0	Be.; 5-5:15 a. m. daily
16.34	18,350	ZLW	Wellington, New Zealand	...	Phone to VK2ME	19.73	15,190	VE9BA	Montreal, Que.	...	Broadcast
16.34	18,345	FZS3	Saigon, Indo China	15.0	Phone	19.85	15,110	DJL	Zeesen, Germany	...	Broadcast
16.33	18,340	WLA	Lawrenceville, N. J.	20.0	Phone 8 a. m.—4 p. m.	19.86	15,104	RAU	Tashkent, U.S.S.R.	20.0	Phone
16.38	18,295	YVQ	Maracay, Venezuela	...	Phone	19.90	15,075	TI4NRH	Heredia, Costa Rica	...	Broadcast
16.43	18,240	FRO-FRE	Ste. Assise, France	30.0	Phone	19.91	15,055	WNC	Hialeah, Florida	0.4	Phone
16.45	18,220	KUS	Manila, P. I.	10.0	Phone	19.93	15,040	RKI	Moscow, U.S.S.R.	20.0	Phone; morn., irr.
16.47	18,200	GAW	Rugby, England	15.0	Phone	20.04	14,980	KAY	Manila, P. I.	40.0	Phone to Dixon, 8 a. m.
16.53	18,135	PMC	Bandoeng, Java	40.0	Phone, sometimes broadcast	20.06	14,940	HJA3	Barranquilla, Colombia	...	Phone to Colombia, Panama, Costa, Rica; 6:30 a. m.—6:30 p. m.
16.55	18,115	LSY3	Buenos Aires, Arg.	10.0	Phone, sometimes broadcast	20.08	14,830	HJB	Bogota, Colombia	...	Phone
16.56	18,100	GBK	Bodmin, England	...	Phone to CGA, 6 a. m.—2 p. m.	20.27	14,830	WKU- W2XBJ	Rocky Pt., N. Y.	40.0	Tests; daytime
16.62	18,040	KQR	Bolinas, Calif.	40.0	Phone	20.50	14,630	XDA	Mexico, D. F.	...	Phone
16.64	18,020	KQJ	Bolinas, Calif.	40.0	Phone; transpacific	20.54	14,600	JVH	Nazaki, Japan	...	Phone
16.66	18,000	PLE	Bandoeng, Java	...	Phone	20.55	14,590	WMN	Lawrenceville, N. J.	20.0	Phone to England; daylight
16.67	18,000	KQG	Bolinas, Calif.	40.0	Phone	20.63	14,535	HBJ	Geneva, Switzerland	20.0	Phone
16.69	17,980	KQZ	Bolinas, Calif.	40.0	Phone	20.64	14,530	LSN	Buenos Aires, Arg.	...	Phone
16.78	17,870	OEV	Vienna, Austria	...	Phone	20.68	14,500	TIN	Cartago, Costa Rica	...	Phone to WNC
16.80	17,850	PLF	Bandoeng, Java	...	Phone	20.68	14,500	TGF	Guatemala City	...	Phone to WNC
16.84	17,800	XGOX	Nanking, China	...	Broadcast	20.69	14,490	LSN	Buenos Aires, Arg.	...	Phone irr.
16.84	17,800	PCV	Kootwijk, Holland	40.0	Phone to Java, 6 a. m.—9 a. m.	20.70	14,485	HPF	Panama City	25.0	Phone to WNC
16.85	17,790	XGBB	Shanghai, China	...	Phone	20.71	14,480	YNA	Managua, Nicaragua	...	Phone to WNC
16.85	17,790	GSG	Daventry, England	15.0	Broadcast	20.76	14,440	GBW	Rugby, England	15.0	Phone
16.86	17,780	W3XAL	Bound Brook, N. J.	15.0	Broadcast	20.79	14,420	VPD	Suva, Fiji Is.	...	Phone
16.86	17,780	W2XAA	Chicago, Illinois	0.5	Exp.	21.52	13,940	YOI	Bucharest, Roumania	...	Broadcast
16.86	17,780	W8XK	Pittsburgh, Pa.	40.0	Broadcast; relays KDKA	21.53	13,925	WIK	Rocky Point, N. Y.	...	Phone
16.87	17,775	PHI	Huizen, Holland	20.0	Broadcast, summer months	21.57	13,900	WQP	Rocky Point, N. Y.	...	Phone to RNE
16.88	17,760	DJE	Koenigswusterhausen, Germany	8.0	Broadcast	21.62	13,870	WIY	Rocky Point, N. Y.	...	Tests, irr.
16.89	17,750	IAC	Coitano, Italy	14.0	Phone; early mornings	21.71	13,811	SUZ	Abu Zabal, Egypt	10.0	Phone
16.90	17,740	HSP	Bangkok, Siam	20.0	Phone	21.76	13,780	KKW	Bolinas, Calif.	...	Phone
16.93	17,713	HJ4ABA	Medellin, Colombia	...	Broadcast	21.79	13,740	CGA	Drummondville, Que.	...	Phone
17.00	17,640	GFVV	S.S. Majestic	...	Phone	21.90	13,690	KKZ	Bolinas, Calif.	40.0	Phone
		GLSQ	S.S. Olympic	...	Phone	21.90	13,685	HAT	Székesszék, Hungary,	5.0	Broadcast
		GDLJ	S.S. Homeric	...	Phone	22.02	13,610	JYK	Kemikawa-Cho, Japan	...	Broadcast and tests
		GTSD	S.S. Monarch of Bermuda	...	Phone	22.06	13,591	GBC	Rugby, England	...	Phone to CGA & ships
		GKPY	S.S. Minnetonka	...	Phone	22.24	13,480	WAJ	Rocky Point, N. Y.	...	Exp.
		GMBJ	S.S. Empress of Britain	...	Phone	22.29	13,450	GBQ	Rugby, England	15.0	Phone
17.11	17,520	DFB	Nauen, Germany	7.2	Phone	22.34	13,420	TIFP	San Jose, Costa Rica	...	Broadcast
17.11	17,510	VWY	Kirkee, India	...	Phone	22.39	13,390	WMA	Lawrenceville, N. J.	20.0	Phone
17.23	17,400	JIAA	Kemikawa-Cho, Japan	...	Phone to Australia	22.47	13,340	CGA	Drummondville, Que.	...	Phone
17.33	17,310	W3XL	Bound Brook, N. J.	20.0	Exp.	22.47	13,340	YVQ	Maracay, Venezuela	...	Phone

Meters Kc	Call	Location	Kw	Service, etc.	Meters Kc	Call	Location	Kw	Service, etc.
22.56	13,285	CGA3	15.0	Phone to ships	28.86	10,390	KER	40.0	Phone
22.64	13,240	KBJ	40.0	Phone	28.86	10,390	GBX	...	Phone
22.66	13,230	GFVW	...	Phone	28.88	10,380	WCG	4.0	Phone; exp.
		GLSQ	...	Phone	28.97	10,350	LSX	12.0	Phone
		GDLJ	...	Phone	29.01	10,335	ZFD	1.5	Phone
		GTSJ	...	Phone	29.03	10,330	ORK	11.0	Broadcast
		GKFY	...	Phone	29.11	10,300	LSL	5.0	Phone to Europe
22.71	13,200	GMBJ	...	Phone	29.14	10,290	HPC	...	Phone
22.92	13,030	ORP	...	Phone	29.14	10,280	DIQ	...	Phone to Sydney
23.00	13,040	DDAC	...	Broadcast	29.22	10,260	PMN	...	Phone; occasional bc.
		DDAS	...	Phone	29.34	10,220	PSH	12.0	Phone
		DDBR	...	Phone	29.39	10,200	CMHB	...	Broadcast
		DDCB	...	Phone	29.50	10,160	DTB	...	Phone
		DDCG	...	Phone			DDAC	...	Phone
		DDCP	...	Phone			DDAS	...	Phone
		DDDT	...	Phone			DDBR	...	Phone
		DDDX	...	Phone			DDCB	...	Phone
		DDEA	...	Phone			DDCG	...	Phone
		DDED	...	Phone			DDCP	...	Phone
		DDFF	...	Phone			DDDT	...	Phone
		DDFT	...	Phone			DDDX	...	Phone
		DDNY	...	Phone			DDEA	...	Phone
		DFC	...	Phone			DDED	...	Phone
23.10	12,980	DFC	...	Phone			DDFF	...	Phone
23.19	12,951	OEX	...	Phone			DDFT	...	Phone
23.35	12,840	WOO	20.0	Phone to ships			DDNY	...	Phone
23.37	12,830	CNR	12.0	Broadcast; Sundays	29.57	10,140	OPM	15.0	Phone to ORK
23.43	12,795	IAC	52.0	Phone to Tripoli	29.77	10,070	EBY	10.0	Exp.
23.46	12,780	GBC	5.0	Phone	29.84	10,055	ZFB	1.5	Phone to WNB
23.51	12,745	DAF	5.0	Phone to ships	29.84	10,055	SUV	10.0	Phone to GAA
24.19	12,396	CTIGO	...	Broadcast	29.89	10,033	OER	...	Phone
24.29	12,345	KNRA	...	Phone	29.99	10,000	...	2.5	Broadcast
24.39	12,295	ZLT	1.0	Phone to Australia	30.01	9,990	KAZ	40.0	Phone to PLV, morn.
24.40	12,290	PLM	...	Phone to VLK	30.09	9,964	LSL	...	Phone
24.40	12,290	ZLW	...	Phone	30.10	9,960	IRS	15.0	Phone
24.46	12,260	FTN	30.0	Phone	30.10	9,950	CGU	15.0	Phone
24.48	12,250	FTN	...	Phone	30.13	9,930	HKB	...	Phone
24.48	12,250	GBS	...	Phone	30.19	9,930	YBF	1.0	Phone
24.60	12,190	YBJ	2.5	Phone to Holland	30.19	9,930	HJY	...	Phone to OCI
24.69	12,150	GBS	15.0	Phone to USA	30.26	9,905	CGA5	...	Tests with Rugby
24.69	12,150	FQO, FQE	...	Phone	30.32	9,890	LSN2	5.0	Phone to Europe and USA
24.74	12,120	SUV	...	Phone	30.38	9,870	WON	20.0	Phone to England
24.78	12,100	CJA4	15.0	Tests with VIY-VK3ME	30.41	9,860	EAQ	20.0	Broadcast
			60.0	Phone	30.47	9,840	JYS	10.0	Broadcast and tests
			...	Time signals, 10 p.m.	30.47	9,840	FTI	15.0	Phone
			...	Time signals, noon	30.50	9,830	LSI	10.0	Phone
			20.0	Phone	30.53	9,820	IRM	25.0	Phone; relays
			0.5	Broadcast	30.63	9,790	GCW	15.0	Phone
			...	Tests with CJA4	31.07	9,650	I2RO	...	Broadcast
			...	Drummondville	30.72	9,760	VLJ	3.5	Phone
24.99	12,000	RW59	20.0	Broadcast, Sun.; Wed.	30.75	9,750	WOF	20.0	Phone
		RNE	20.0	Phone	30.88	9,710	GCA	10.0	Phone; evenings
		FZS2	15.0	Phone to FTK	30.91	9,700	WMI	...	Phone
		KKQ	40.0	Phone	30.91	9,700	LQA	...	Phone
		FTA	30.0	Phone to Rabat	30.97	9,680	T14NRH	...	Broadcast
		XGOX	...	Broadcast	31.10	9,640	HSP2	...	Broadcast
		FYA	...	Broadcast	31.17	9,620	DGU	...	Phone to Egypt
		W9XF	...	Be.; relays WENR	31.18	9,616	VQ7LO	...	Broadcast
		W8XK	40.0	Be.; relays KDKA	31.23	9,600	LQA	...	Phone
		VUC	3.0	Broadcast	31.23	9,600	LGN	...	Phone
		VE9CA	...	Broadcast	31.23	9,600	CT1AA	2.0	Broadcast
		GSE	20.0	Broadcast	31.23	9,600	XETE	...	Broadcast
		DJP	50.0	Exp.	31.26	9,590	WKJ	...	Phone
		KZRM	6.0	Broadcast	31.26	9,590	W3XAU	1.0	Be.; relays WCAU
		VE9HX	...	Be.; relays CHNS	31.26	9,590	VK2ME	20.0	Broadcast; Sundays
		W9XAA	0.5	Be.; relays WCFL	31.26	9,590	HP5J	...	Broadcast
		W2XE	5.0	Be.; relays WABC	31.26	9,590	TIRA	...	Broadcast
		I2RO	9.0	Broadcast	31.28	9,585	HLB	18.0	Broadcast
		VE9GW	0.5	Broadcast	31.30	9,580	XGBD	18.5	Broadcast
		OER3	0.25	Broadcast	31.30	9,580	VE9DR	...	Exp.
		DJO	50.0	Exp.	31.30	9,580	GSC	20.0	Broadcast
		W1XAL	5.0	Broadcast	31.30	9,580	VK3LR	20.0	Broadcast
		T1TR	...	Broadcast	31.32	9,572	LKJ1	...	Exp.
		VE9DN	...	Broadcast	31.33	9,570	W1XK	10.0	Be.; relays
		VE9DR	...	Exp.				...	WBZ-WBZA
		DJD	5.0	Broadcast	31.33	9,570	KZRM	6.0	Broadcast
		XDA	...	Exp.	31.33	9,570	SRI	1.0	Broadcast
		GSD	...	Broadcast	31.33	9,570	SUV	...	Broadcast
		PHI	20.0	Be.; winter months	31.34	9,565	VUB	...	Broadcast
		FYA	15.0	Broadcast	31.36	9,560	DJA	5.0	Broadcast
		CJRX	2.0	Broadcast	31.38	9,555	VE9DN	...	Broadcast
		HJ4ABA	0.05	Broadcast	31.43	9,540	DJN	50.0	Broadcast
		YV2RC	...	Broadcast	31.46	9,530	W2XAF	40.0	Be. re. WG Y, 5-11 p.m.
		YVQ	...	Phone	31.49	9,520	OXY	0.5	Broadcast
		KIO	40.0	Phone to Bolinas	31.53	9,510	GSB	20.0	Broadcast
		PPQ	5.0	Exp. irr., evenings	31.53	9,510	VK3ME	2.0	Be. Wed., Sat., 5-7 a.m.
		GBK	...	Phone	31.53	9,510	YV3RC	...	Broadcast
		IBDK	...	Exp.	31.56	9,501	PRF5	...	Broadcast
		DAN	...	Time signals; 7 a.m., 7 p.m.	31.56	9,500	XGOX	...	Broadcast
			0.05	Tests with XDA	31.56	9,500	HSP2	2.5	Broadcast
			3.0	Phone, occa. bc.	31.59	9,490	WEF	40.0	Phone
			...	Phone to Austr. morn.	31.59	9,490	KEI	26.0	Phone
			...	Phone	31.61	9,485	PLW	...	Phone
			...	Phone to Hawaii	31.63	9,480	KET	40.0	Phone
			...	Phone, occasional bc.; relays JOAK	31.73	9,450	WES-	...	Phone
			...	Phone			W2XBJ	40.0	Exp.
			...	Phone to Bermuda; day	31.80	9,428	COH	...	Broadcast
			...	Phone	31.84	9,415	PLV	80.0	Phone; sometimes bc.
			...	Be.; relays JOAK	31.90	9,400	XDC	...	Exp.
			...	Phone to Holland and France	31.96	9,380	CE32	0.05	Phone
			...	Phone to Europe	31.98	9,375	XDA	...	Phone
			...	Exp.	31.98	9,375	EH9OC	...	Phone
			...	Time signals at 5:26 a.m. and 6:26 p.m.	32.00	9,370	CT3AQ	...	Broadcast
			...	Phone	32.13	9,332	CJA2	15.0	Phone to England
			...	Phone	32.24	9,300	CNR	...	Broadcast; Sundays
			...	Phone	32.31	9,280	GCB	15.0	Phone
			...	Phone	32.41	9,250	GBK	...	Phone to Drummondville
			...	Phone				...	Phone to Europe
			...	Phone	32.66	9,180	YVR	20.0	Phone to England
			...	Phone	32.70	9,170	WNA	20.0	Broadcast
			...	Phone, occasional bc.	32.86	9,125	HAT4	...	Broadcast
			...	Phone	32.88	9,120	CP6	...	Broadcast
			...	Phone	32.93	9,104	LST	...	Phone
			...	Phone	33.13	9,050	TFK	...	Broadcast
			...	Phone	33.24	9,020	GCS	15.0	Phone
			...	Phone	33.28	9,010	KEJ	40.0	Phone; relays NBC programs for KGBM
			...	Phone				...	Phone to England; mornings
			...	Phone; irr. early morn.	33.40	8,975	VWY	...	Phone to England; mornings

Meters Kc	Call	Location	Kw	Service, etc.	Meters Kc	Call	Location	Kw	Service, etc.
33.48	8,955 TGX	Guatemala City, Guatemala	Broadcast					
33.50	8,950 WEL- W2XBJ	Rocky Point, N. Y.	Exp.	43.80	6,845 VRO	Suva, Viti Levu, Fiji Is.	0.042	Exp.
33.59	8,925 WEC	Rocky Point, N. Y.	Exp.	43.83	6,840 VFP	Taveuni, Taveuni, Fiji Is.	0.042	Exp.
33.69	8,900 ZLT	Wellington, New Zealand	1.0	Phone to Sydney	43.83	6,840 KEN	Bolinas, Calif.	40.0	Phone
33.80	8,870 NPO	Manila, P. I.	Time sig., 10 p.m.	44.00	6,814 CFA	Drummondville, Que.	Phone
33.92	8,840 KNRA	Schooner Seth Parker	Phone	44.38	6,755 HAT2	Székesszférvár, Hungary	20.0	Broadcast
33.95	8,830 GDLJ	S.S. Homeric	Phone	44.42	6,750 HIH	San Pedro de Macoris, D. R.	0.015	Phone
		S.S. Majestic	Phone	44.48	6,750 WOA	Lawrenceville, N. J.	20.0	Phone
		S.S. Minnetonka	Phone	44.48	6,740 W2XBJ	Nazaki, Japan	Phone; bc.; re. JOAK
		S.S. Olympic	Phone					
		S.S. Empress of Britain	Phone	44.62	6,720 WQO	Rocky Point, N. Y.	Exp.
		S.S. Monarch of Bermuda	Phone	44.64	6,716 KBK	Rocky Point, N. Y.	Phone
34.11	8,790 TIR	Cartago, Costa Rica	Phone to Guatemala, Colombia, Florida	44.68	6,710 TIEP	Manila, P. I.	40.0	Phone
			Phone, oc. bc.	44.68	6,710 KEF	San Jose, Costa Rica	40.0	Broadcast
34.17	8,775 PNI	Makassar, Celebes	3.0	Phone, oc. bc.	44.71	6,705 WER	Bolinas, Calif.	40.0	Phone
34.19	8,770 RSZ	Irkutsk, U.S.S.R.	Phone	44.71	6,705 HBQ	Rocky Point, N. Y.	Phone
34.50	8,690 W2XAC	Schenectady, N. Y.	Exp.	44.81	6,675 YVQ	Geneva, Switzerland	20.0	Exp.
34.54	8,680 GBC	Rugby, England	5.0	Phone to ships; after.	44.94	6,672 YVQ	Maracay, Venezuela	Phone
34.66	8,650 VE9BY	London, Ont.	Exp.	44.97	6,668 HC2RL	Guayaquil, Ecuador	0.2	Broadcast
34.66	8,650 W2XCU	Rocky Point, N. Y.	Exp.	44.99	6,664 YNCRG	Granada, Nicaragua	Broadcast
34.74	8,630 W2XDO	Ocean Gate, N. J.	Exp.	45.02	6,660 KNRA	Schooner Seth Parker	Phone; relays programs to W2XBJ
34.74	8,630 WOO	Deal, N. J.	Phone					
34.98	8,570 RW15	Khabarovsk, Siberia	Broadcast	45.09	6,650 TITE	San Jose, Costa Rica	Broadcast
35.00	8,566 IBEJ	S.S. Conte Rosso	Phone	45.09	6,650 IAC	Coltana, Italy	Phone
		S.S. Rex	Phone	45.32	6,616 PRADO	Riobamba, Ecuador	Broadcast, Thursdays
		S.S. Conte di Savoia	Phone	45.35	6,611 REN			
		Ocean Gate, N. J.	20.0	Phone to ships	45.98	6,520 RW72	Moscow, U.S.S.R.	10.0	Broadcast
35.03	8,560 WOO	Norddeich, Germany	Phone to ships	46.02	6,515 YV6RV	Valencia, Venezuela	Broadcast
35.48	8,450 PRAG	Porto Alegre, Brazil	Phone; occasional bc.	46.10	6,504 WOO	Deal, N. J.	Phone
35.69	8,400 HC2AT	Guayaquil, Ecuador	Broadcast	46.20	6,490 TPK	San Jose, Costa Rica	Broadcast
35.78	8,380 IAC	Coltano, Italy	14.0	Phone	46.20	6,490 HJ5ABD	Cali, Colombia	0.25	Broadcast
36.00	8,328 DDAC	S.S. Europa	Phone	46.25	6,482 HI4D	Santo Domingo, D. R.	Broadcast
		S.S. Bremen	Phone	46.48	6,450 HJ1ABB	Barranquilla, Colombia	0.3	Broadcast
		S.S. Berlin	Phone	46.67	6,425 VE9AS	Fredericton, N. B.	Broadcast
		S.S. Columbus	Phone	46.67	6,425 VE9BY	London, Ont.	Broadcast
		S.S. Resolute	Phone	46.67	6,425 W3XL	Bound Brook, N. J.	18.0	Exp.
		S.S. Cap Polonio	Phone	46.70	6,420 RCAD	Minsk, U.S.S.R.	0.15	Phone
		S.S. Deutschland	Phone	46.73	6,416 HJ3A	Barranquilla, Colombia	Phone
		S.S. Hamburg	Phone	46.85	6,400 YNIGG	Managua, Nicaragua	Broadcast
		S.S. Cap Arcona	Phone	46.99	6,380 YN1OP	Managua, Nicaragua	Broadcast
		S.S. New York	Phone	47.04	6,375 YV4RC	Caracas, Venezuela	0.1	Broadcast
		S.S. Reliance	Phone	47.36	6,350 JZG	Nazaki, Japan	10.0	Phone
		S.S. Albert Ballin	Phone	47.48	6,315 HJZ	Santo Domingo, D. R.	0.02	Broadcast
		Rio de Janeiro, Brazil	10.0	Phone; broadcast	47.78	6,275 HJ3ABF	Bogota, Colombia	0.1	Broadcast
36.63	8,185 PSK	Moscow, U.S.S.R.	20.0	Broadcast	47.80	6,272 HJIA	San Domingo, D. R.	0.05	Broadcast
36.70	8,170 RW50	Manila, P. I.	40.0	Phone to Dixon, Calif.	47.82	6,270 HJ3ABF	Bogota, Colombia	Phone
36.92	8,120 KIP	Bandoeng, Java	60.0	Phone	47.97	6,250 OCI	Lima, Peru	Phone
36.90	8,125 PLW	Manila, P. I.	20.0	Phone to Dixon, Calif.	48.13	6,230 OAX4B	Lima, Peru	Broadcast
36.90	8,120 KAZ	Quit, Ecuador	0.15	Broadcast	48.13	6,230 HJ4ABC	Pereira, Colombia	Broadcast
36.98	8,108 HCJB	Vienna, Austria	Phone	48.38	6,198 CTIGO	Pared, Portugal	Broadcast
37.01	8,100 EATH	Bogota, Colombia	Phone	48.45	6,188 HJIA	Santiago de los Caballeros, D. R.	0.05	Broadcast
37.01	8,100 HKF	Rabat, Morocco	10.0	Broadcast; Sundays	48.67	6,160 CJRO	Winnipeg, Manitoba	Broadcast
37.32	8,035 CNR	Bangkok, Siam	20.0	Phone	48.67	6,160 KNRA	Schooner Seth Parker	Phone
37.57	7,980 HJZ	Sydney, Australia	Phone to Java	48.75	6,150 COGOC	Santiago, Cuba	Broadcast
37.67	7,960 VLJ	Sydney, Australia	3.5	Phone	48.75	6,150 HJ2ABA	Tunja, Colombia	0.05	Broadcast
38.00	7,890 VPD	Suva, Fiji Islands	Phone	48.75	6,150 YV3RC	Caracas, Venezuela	Broadcast
38.05	7,880 JYR	Kemikawa-Cho, Japan	5.0	Broadcast	48.75	6,150 YV3RC	Winnipeg, Manitoba	Broadcast
38.06	7,867 SUX	Cairo, Egypt	10.0	Phone	48.75	6,150 YV3RC	Winnipeg, Manitoba	Broadcast
38.10	7,870 RXC	Panama City	Phone	48.75	6,150 YV3RC	Winnipeg, Manitoba	Broadcast
38.29	7,830 PGA	Kootwijk, Holland	60.0	Phone	48.83	6,140 KZRM	Lisbon, Portugal	Broadcast
38.34	7,820 OA4C	Lima, Peru	20.0	Broadcast	48.83	6,140 W8XX	Manila, P. I.	6.0	Broadcast
38.49	7,790 HBP	Geneva, Switzerland	20.0	Broadcast	48.90	6,132 ZGE	Pittsburgh, Pa.	40.0	Bc.; relays KDKA
38.50	7,788 YNLF	Managua, Nicaragua	Broadcast	48.91	6,130 XETE	Kuala Lumpur, F. M. S.	0.18	Broadcast
38.59	7,770 FTE	St. Assise, France	Phone	48.91	6,130 XETE	Jeloy, Norway	Broadcast
38.79	7,730 PDL	Kootwijk, Holland	20.0	Phone	48.91	6,130 XETE	Mexico, D. F.	Broadcast
38.86	7,715 KEE	Bolinas, Calif.	40.0	Phone; relays NBC programs for KGMB	48.91	6,130 XETE	Mexico, D. F.	Broadcast
			Phone	48.98	6,122 ZTJ	Montreal, Que.	Broadcast
38.94	7,700 HC2J5B	Guayaquil, Ecuador	Broadcast	48.98	6,122 ZTJ	Johannesburg, So. Africa	5.0	Broadcast
39.23	7,632 OEJ	Vienna, Austria	Phone	48.99	6,120 HJ1ABE	Cartagena, Colombia	0.05	Broadcast
39.31	7,626 RIM	Tashkent, U.S.S.R.	20.0	Phone to RKI, 6-8-15 a.m.	48.99	6,120 VE9HK	Halifax, N. S.	Broadcast
			Phone to RKI, 6-8-15 a.m.	48.99	6,120 W2XE	Wayne, N. J.	5.0	Bc.; relays WABC
39.40	7,610 KWX	Dixon, Calif.	20.0	Phone to Hawaii, nights	48.99	6,120 W2XE	Wayne, N. J.	5.0	Bc.; relays WABC
39.63	7,565 KQY	Dixon, Calif.	20.0	Phone	49.05	6,112 YV2RC	Bandoen, Java	Broadcast
39.86	7,522 HJA3	Barranquilla, Colombia	Phone; 6:30 a.m.-6:30 p.m.	49.07	6,110 VE9HX	Caracas, Venezuela	0.2	Broadcast
			Phone	49.07	6,110 YUC	Halifax, N. S.	0.2	Bc.; relays CHNS
			Phone	49.07	6,110 VE9CG	Calcutta, India	2.0	Broadcast
			Phone	49.10	6,106 GSL	Calgary, Alberta	Broadcast
			Phone	49.15	6,100 HJ1ABD	Daventry, England	0.025	Broadcast
			Phone	49.15	6,100 HJ4ABL	Cartagena, Colombia	0.2	Broadcast
			Phone	49.15	6,100 W3XAL	Manizales, Colombia	Broadcast
			Phone	49.15	6,100 W9XF	Bound Brook, N. J.	Broadcast
			Phone	49.15	6,100 VE9CF	Chicago, Ill.	5.0	Bc.; relays WJZ
			Phone	49.23	6,090 VE9BJ	Halifax, N. S.	Broadcast
			Phone	49.23	6,090 VE9GW	St. John, N. B.	0.1	Broadcast
			Phone	49.26	6,085 I2RO	Bowmanville, Ontario	0.5	Broadcast
			Phone	49.31	6,080 TIRA	Rome, Italy	Broadcast
			Phone	49.31	6,080 VE9EH	Cartago, Costa Rica	Broadcast
			Phone	49.31	6,080 W9XAA	Charlottetown, P. E. I.	Broadcast
			Phone	49.31	6,080 CP5	Chicago, Ill.	0.5	Bc.; relays WCFL
			Phone	49.37	6,073 DJM	La Paz, Bolivia	Broadcast
			Phone	49.37	6,073 CQN	Berlin, Germany	Exp.
			Phone	49.37	6,073 ZHJ	Macao, Asia	0.5	Broadcast
			Phone	49.37	6,072 OER2	Penang, Straits Settlements	Broadcast
			Phone	49.39	6,070 VE9CS	Vienna, Austria	0.25	Broadcast
			Phone	49.39	6,070 HJ1ABF	Vancouver, B. C.	0.01	Broadcast
			Phone	49.39	6,070 W3XAU	Barranquilla, Colombia	Broadcast
			Phone	49.48	6,060 OXY	Philadelph, Pa.	1.0	Bc.; relays WCAU
			Phone	49.48	6,060 VQ7LO	Skamlebaek, Denmark	0.05	Broadcast
			Phone	49.48	6,060 W8XAL	Nairobi, Kenya, Africa	1.25	Broadcast
			Phone	49.48	6,060 CMCI	Cincinnati, Ohio	10.0	Bc.; relays WLW
			Phone	49.48	6,060 ZL2ZX	Havana, Cuba	0.02	Broadcast
			Phone	49.48	6,060 VE9CF	Wellington, New Zealand	Broadcast
			Phone	49.56	6,050 VE9CF	Halifax, N. S.	Broadcast
			Phone	49.56	6,050 HJ3ABI	Bogota, Colombia	0.05	Broadcast
			Phone	49.56	6,050 GSA	Daventry, England	Broadcast
			Phone	49.62	6,042 HJ1ABG	Barranquilla, Colombia	0.1	Broadcast
			Phone	49.64	6,040 W1XAL	Boston, Mass.	5.0	Broadcast
			Phone	49.64	6,040 PRA8	Pernambuco, Brazil	Broadcast
			Phone	49.64	6,040 W4XB	Miami Beach, Fla.	2.5	Broadcast
			Phone	49.64	6,040	Bandoeng, Java	3.0	Broadcast
			Phone	49.72	6,030 VE9CA	Calgary, Alta.	Bc.; relays CFCN
			Phone	49.72	6,030 HP5B	Panama City	Broadcast
			Phone	49.78	6,023 XEW	Mexico City, D. F.	Broadcast
			Phone	49.80	6,020 DJC	Zeesen, Germany	8.0	Broadcast
			Phone	49.82	6,018 HJ3ABH	Bogota, Colombia	Broadcast
			Phone	49.82	6,018 ZHI	Singapore, F. M. S.	0.09	Broadcast
			Phone	49.85	6,015 HRP1	San Pedro Sula, Honduras	Broadcast
			Phone	49.85	6,015 VE9CX	Wolfville, N. S.	Broadcast
			Phone	49.89	6,010 COC	Havana, Cuba	0.25	Broadcast
			Phone	49.89	6,010 XEBT	Mexico, D. F.	Broadcast
			Phone	49.93	6,005 VE9DR	Drummondville, Que.	0.05	Bc.; relays CFCF
			Phone	49.93	6,005 VE9DN	Montreal, Que.	4.0	Broadcast
			Phone	49.93	6,005 VE9CU	Calgary, Alta.	Broadcast
			Phone	49.97	6,000 YOI	Bucharest, Rumania	0.3	Broadcast
			Phone	49.97	6,000 XGOX			

Meters Kc	Call	Location	Kw	Service, etc.	Meters Kc	Call	Location	Kw	Service, etc.
49.97	6,000	FIQA	0.4	Broadcast	62.53	4,795	VE9BY	...	Broadcast
49.97	6,000	St. Denis, Reunion	0.09	Broadcast	62.60	4,785	CZA	10.0	Phone to ships
49.97	6,000	EAJ25	...	Broadcast	62.86	4,770	ZL2XX	...	Phone
49.97	6,000	ZL3ZC	0.25	Broadcast	63.10	4,752	WOO	20.0	Phone
49.97	6,000	RW59	20.0	Broadcast	63.10	4,752	WOY	20.0	Phone to England
49.97	6,000	YV4BSG	...	Broadcast	64.48	4,650	HC2EP	...	Broadcast
50.00	5,996	PRA8	0.5	Broadcast	66.45	4,512	ZFS	...	Phone
50.11	5,984	TGX	...	Broadcast	67.07	4,470	YID	...	Broadcast
50.10	5,984	YV4RC	0.1	Broadcast	67.68	4,430	DOA	...	Phone
50.14	5,980	CT1AA	...	Broadcast	68.61	4,370	...	0.2	Broadcast
50.14	5,980	XECW	0.01	Broadcast	69.24	4,330	...	0.15	Broadcast
50.14	5,980	HIX	...	Broadcast	69.44	4,320	GDB	15.0	Exp.
50.14	5,980	H3ABH	0.25	Broadcast	69.46	4,316	YNLF	...	Broadcast
50.22	5,970	YNLF	0.1	Broadcast	69.81	4,295	WTDX	0.25	Exp.
50.23	5,969	HVJ	10.0	Broadcast	69.81	4,295	WTDV	0.25	Exp.
50.47	5,940	HJ1ABJ	0.25	Broadcast	69.81	4,295	WTDW	0.25	Exp.
50.56	5,930	H4ABE	0.1	Broadcast	70.00	4,283	IBEJ	...	Phone
50.90	5,890	JIC	...	Broadcast	ICEJ	...	Phone
51.08	5,870	H2ABC	...	Broadcast	70.17	4,273	RW15	20.0	Broadcast
51.16	5,860	XDA	...	Phone	70.55	4,250	HJA3	...	Phone
51.23	5,852	WNB	...	Phone	71.78	4,177	GFVV	...	Phone
51.25	5,850	YV5RMO	0.3	Broadcast	GLSQ	...	Phone
51.29	5,845	KRO	40.0	Phone	GDLJ	...	Phone
51.64	5,805	CSN	...	Exp.	GTSD	...	Phone
51.69	5,800	VE3LR	...	Broadcast	GKFY	...	Phone
51.69	5,800	TI4NRH	...	Broadcast	GMBJ	...	Phone
51.87	5,780	OAX4D	20.0	Broadcast	DDAC	...	Phone
51.90	5,777	TI4GPD	...	Broadcast	DDAS	...	Phone
51.97	5,769	XAM	...	Phone	DDBR	...	Phone
52.47	5,714	CFU	...	Broadcast	DDCB	...	Phone
52.47	5,714	HCJB	...	Broadcast	DDCG	...	Phone
52.67	5,692	FIQA	0.5	Broadcast	DDCP	...	Phone
52.87	5,660	XQAJ	...	Broadcast	DDDT	...	Phone
55.52	5,400	HJA7	0.4	Phone	DDDX	...	Phone
55.52	5,400	HAT	20.0	Broadcast	DDDE	...	Phone
57.00	5,260	WQN	40.0	Exp.	DDFD	...	Phone
58.17	5,154	PMY	2.0	Phone; occasional bc.	DDFF	...	Phone
58.27	5,145	OKIMPT	0.5	Broadcast	DDFT	...	Phone
58.67	5,110	KIKB	40.0	Phone	72.95	4,110	HCJB	0.15	Broadcast
58.71	5,105	KEC	40.0	Phone	73.13	4,100	LCL	...	Exp.
58.79	5,100	KJKA	1.0	Phone	73.13	4,100	WND	0.4	Phone
59.05	5,077	WCN	20.0	Phone to England	74.92	4,002	CT2AJ	...	Broadcast
59.67	5,025	ZFA	1.5	Phone	79.53	3,770	HB9B	...	Broadcast
59.96	5,000	WWV	...	Standard frequency trans.; Tue., Fri., 2.30-3.30	79.95	3,750	CT1CT	0.5	Broadcast
60.26	4,975	GBC	5.0	Phone to ships	79.95	3,750	I2RO	12.0	Broadcast
60.33	4,970	G6RX	...	Exp.	82.82	3,620	DOA	...	Phone
60.94	4,920	LCL	...	Exp.	84.63	3,543	CR7AA	...	Phone
61.63	4,865	HJA3	...	Phone	85.06	3,525	HB9AQ	...	Broadcast
62.20	4,820	GDW	...	Phone to US	88.81	3,376	HJA3	...	Broadcast
...	Phone

Testing A NOISE-REDUCING V-ANTENNA

(G. E. V-Doublet)

Some practical tests made in three representative locations

Laurence M. Cockaday

FOR those short-wave fans who are bothered by inductive interference from nearby sources, this new "V" doublet all-wave antenna system will be found very beneficial. The V in this antenna is said by the designing engineers to serve the purpose of providing an efficient transfer of energy from the antenna, directly to the transmission lines and the use of a special transformer again provides an efficient transfer of energy from the lead-in to the receiver, while eliminating any inductive interference which is usually picked up by the lead-in wire. When the package containing the antenna materials was unpacked and the antenna spread out on the ground, it was found that it was already "hooked up," so that all that was necessary was to string the antenna portion between two suitable supports.

Three tests were made with this equipment—one installation being on an apartment house with a noisy elevator system, one being at the Westchester Listening Post for comparison with other types of feeder and noise-reducing antennas, and third in

the location pictured above. When installed on the apartment house, it was noted that the best noise reduction occurred when the end of the antenna wire was pointed directly at the offending elevator shaft. The equipment produced a great decrease of "noise" in short-wave reception, while at the same time decreasing the signal strength only moderately. It made possible, for the first time, good short-wave reception in this location where all previous attempts had failed, according to the owner of the apartment. This in itself is an excellent recommendation of the system. It must be noted, however, that only a slight movement of the antenna to right or left of what might be called a dead-center "point" brought back the interference. Servicemen installing this antenna should therefore take care of this consideration.

In the tests at the Westchester Listening Post, the antenna was erected 35 feet above ground, in the clear, and reception from all over the world and on various frequencies checked and compared against that gotten with the same set on various

other aerials. Its signal-to-noise ratio was considerably better than another antenna (Turn to page 43)

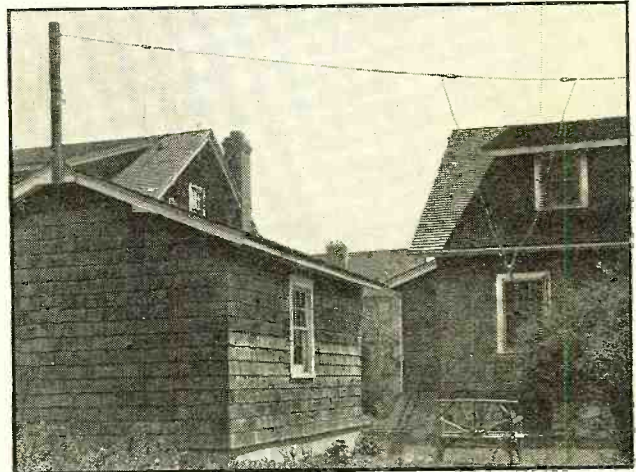



SHORT-WAVE PAGE

IN last month's article we made some reference to a new antenna we were experimenting with. Since that time we have had several weeks in which to experiment with it and note the results.

FIRST we will give a more detailed description of the antenna. The material consists of three 10-foot lengths of 3-inch copper rain spouting, making 30 feet in all. These lengths are soldered together with hard solder, with a cap on top to keep rain water from collecting. Attached to the band of the cap is a small galvanized pulley with a line attached. The base of the pipe sets on a porcelain insulator, known as a petticoat insulator, of the type used for high voltage work. This insulator looks something like an ordinary stone or porcelain jug. The petticoat insulator is bolted to an oak base, 2 inches by 12 inches by 14 inches. A small amount

of roof cement is used between the oak block and the roof. Five feet from the top of the copper antenna is a 1½-inch copper band, with four eyes for making fast the top guys. Eleven feet below this band (or 16 feet from the top) is another similar band also used for guy wires. In the four top guy wires 16 insulators are used. One foot from the band comes the first insulator, the second is three feet from No. 1 and No. 4 is three feet from number three. There are four insulators in each guy wire. In the four lower guy wires there are 12 insulators. The first one is placed one foot from the mast and the others are placed at three-foot intervals. All in all 28 insulators are used in these eight wires. For tightening the wires to the anchors (such as chimneys or pipes) eight 3-inch turnbuckles were used. Only 18 feet square of space was required for this antenna.

From the foregoing the reader might think this new antenna is a heavy and expensive affair. Actually the weight of the mast is 27 pounds—insulators and wire aloft weigh 14 pounds—making a total of only 41 pounds. The entire cost, including pipe, insulators, guy-wires, etc., was \$12.00.

We first tried a Zepp-type lead-in, but found it picked up quite a good deal of noise; therefore we changed and now use a twisted lead-in. One wire is soldered to the extreme lower end of the pipe and the other wire is insulated at the wooden base. This last is done by fastening two insulators (1½-foot apart) to the wooden base. The soldered wire goes to the antenna post of the receiver and the "dead" wire is attached to a ground (but not the ground of the receiver). The writer uses a cold water pipe for this purpose.

Even after we had gone to the trouble of erecting our new copper antenna, we would have been willing entirely to "forget it" if it did not come up to expectations. However, this it did and more! Five other antennas were used in making comparison tests. Starting on the high frequencies we find, approximately: From 16 to 25 meters, an increase in signal strength of one-quarter; from 31 to 49 meters an increase of about half. On the 40-meter band foreign amateurs were picked up that we never had heard before. As little as we know about the 20-meter amateur band (from a receiving point of view) it worked very well.

We have been spending our spare moments experimenting with our recording outfit and now after half a year's work behind us, we feel we can tell other fans what we found out. Our recorder, designed and built by the writer, is now safely enclosed in a rack.

The motor runs at a speed of 78 r.p.m. and is absolutely noiseless. The recorder can be hooked up to each of my receivers and all that is necessary to record a program is to throw a switch.

Verifications sometimes can be falsely acquired, but when you have a *recording of the program*, even the most "doubting Thomases" must believe you heard the station.

Informal Tests on a FIVE-TUBE TRIPLE-BAND RECEIVER

(Bosch Model 430T)

Actual listening tests at the
Westchester Listening Post

Victor Hall



WHEN the Model 430T, 5-tube, triple-band receiver was unpacked at the Westchester Listening Post recently and placed in operation, quite a few surprises were in store for the operators who made the test. The receiver employs five vacuum tubes for the following purposes: The detector-oscillator is a type 6A7 with a type 6D6 used as an intermediate amplifier. A type 75 tube functions as a second detector, a.v.c.

and audio amplifier. The output tube is a type 42 power pentode and the whole set is powered through a rectifier using a type 80 rectifier tube. Looking at the set from the front, the upper knob is the tuning dial which is equipped with a "fast" and "slow" movement. The three lower knobs are, starting from the left, the power switch and volume control; the tone control and police range switch; and the wave-change switch at the extreme right. The

wave-change switch changes a line of light (which acts as a pointer) as one dials from the long-wave to the short-wave position. The receiver covers a range from 540 to 1750 kc. and, by turning the police range switch, also covers a range from 2400 to 2600 kc. as well as the regular short-wave bands from about 5800 to 18,000 kc., taking in all bands between 16- and 50-meter wavelengths. The receiver works on 60-

(Turn to page 53)

Making YOUR OWN HOME TALKIES

John Strong



AN amateur talkie camera, permitting anyone to make his own sound pictures, has been produced by the R.C.A. Manufacturing Company. The device utilizes a special 16-millimeter film with sprocket perforations on just one side, the opposite track being reserved for sound recording. Home talkies had long been in vogue, but now the cinema fans have the opportunity of making their own talkies instead of depending on rental libraries.

In size and appearance, there is but small difference between the R.C.A. camera and the usual silent camera. The unit weighs slightly less than nine pounds, including a reel of film.

The camera itself is limited in its sound pick-up scope to the voice of the operator. But a kit of special microphone and amplifying equipment is offered as optional equipment. The auxiliary sound apparatus permits of the recording of voices at a distance from the sound camera, in true professional cinema fashion.

In operating the sound camera without

auxiliary equipment, the photographer talks into a mouthpiece recessed in the back of the camera which he holds to eye-level. A vibrating metal diaphragm coupled mechanically to a small mirror is set in motion by the voice, and a fluctuating light beam directed on the mirror is reflected on to the sensitized film edge as it passes by.

With the use of the separate microphone and amplifier, the basic principles are quite the same, the chief difference being that the tiny recording mirror in the camera is operated electrically from a distance.

Special tripod mounting is available for the camera as well as the supplementary amplifiers and batteries for distant sound recording. The special 16-mm. reversible sound film with the single sprocket perforations is produced by the Eastman Kodak Company.

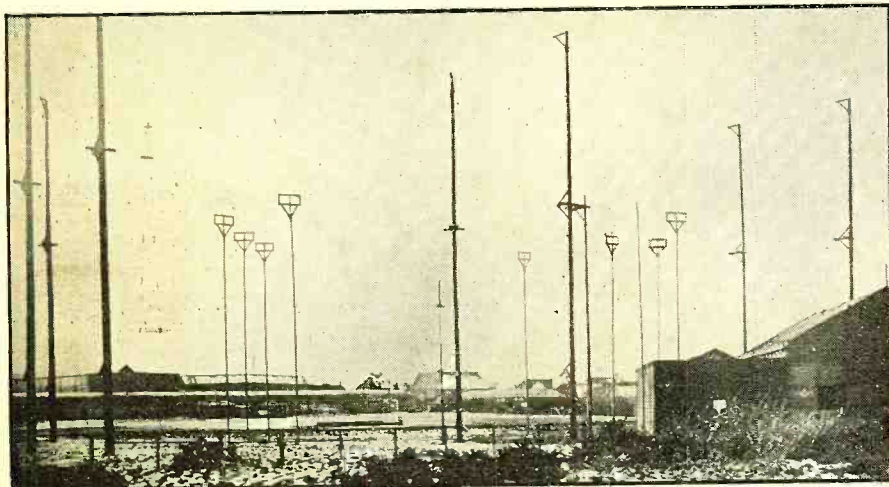

THE UNIQUE ANTENNA ARRAY AT PCJ

Here are shown the queer-looking antennas and supports used by the experimental short-wave station at Eindhoven, Holland.

A GREAT deal of the credit for international radio reception on the high frequencies should be credited to the work of various scientific short-wave societies and magazines who have helped to make it popular, to solve its problems, and to furnish definite and up-to-date information regarding the stations in operation, together with their frequencies and hours of operation. It is a commonly known fact that short-wave stations do not operate at all hours, or every day. It is also well known that these stations change their wavelengths with the changing seasons, and some of the large stations use different frequencies at certain hours

of the day. Short-wave broadcasting also covers only narrow bands within a wide wave spectrum which runs from 1500 to some 40, or even 50 thousand kilocycles, including thousands of separate channels. A lot of credit is due to the clubs of Listening Post Observers who have searched out information on these stations and have printed regularly revised short-wave lists, and schedules of operation. If it were not for the up-to-date and accurate short-wave time table, all the best equipment in the world would be of very little use, as it would be like searching for a "needle in a hay-stack" to find out when the stations were operating, where they were lo-

The Future of SHORT WAVES

C. A. Morrison

Part Four

cated, and upon what frequencies they were operating.

Speaking in a commercial sense the uses to which the short waves may be put, are almost unlimited. The field of their usefulness has barely been scratched. The most common commercial application of short waves that concern international short-wave reception is that in use by the trans-oceanic telephone circuits. These circuits have already made it possible for us to converse enjoyably with someone thousands of miles away, separated by oceans, mountains and continental boundaries. World telephone service now makes it possible for you to pick up your home telephone, and ask for London, Moscow, or Tokyo and be sure of a fair connection within a comparatively short period of time. These systems, too, will be vastly improved, permitting almost instant connections with all foreign countries and at a fraction of the cost that makes such traffic prohibitive for ordinary use. All telephone calls will be "scrambled" in the

(Turn to page 52)

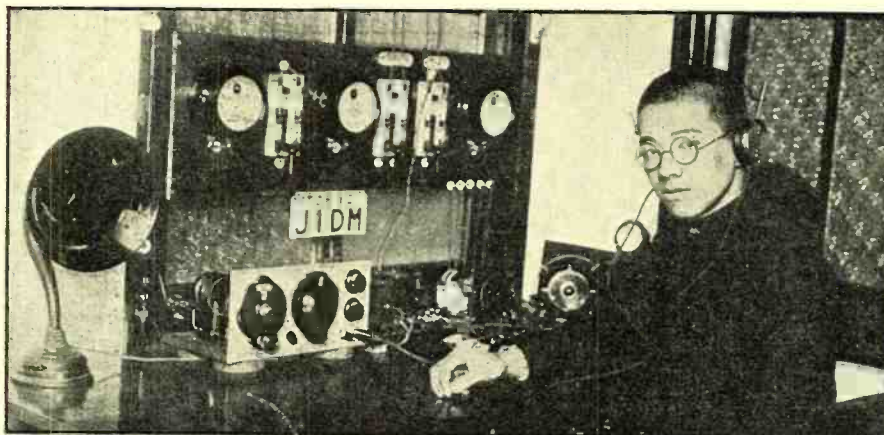

THE "HAM" SHACK

CQ CQ CQ

THIS department has received numerous letters from amateurs regarding the "problem" of cards received from short-wave listeners. The majority disfavor the practice, arguing that if the amateur were to reply with QSL cards to all of those received from listeners, it would be a costly business. On the other hand, the shortwave listener who takes the trouble to advise the owner of an amateur station of reception of his signals is entitled to some acknowledgement. Those who argue that the cost makes it prohibitive are to some extent exaggerating the issue. This department made a survey recently of prominent amateur 'phone stations. 'Phone stations, it must be remembered, receive considerably more SWL cards than the C.W. stations. Five stations were included in the survey. The average number of cards received during an average operating week by these stations was seven. One station using a power of 400 watts on 150 meters received in a peak week, fourteen. Another station on this same band using about 100 watts received about one a month. A third station using about 300 watts on 75 meters received an average of four a week.

UNDoubtedly there are a number of powerful amateur stations with interesting talkers as operators that receive more SWL cards than seven a week, but this may be taken as a representative figure. Now to compute the cost. A QSL card costs about one cent, and it costs about one cent for mailing; therefore, 14 cents a week—\$7.28 a year. True, that may buy a tube or two, but when spread out over a year, it does not amount to much. Furthermore, it is becoming increasingly the practice of short-wave listeners to enclose a return stamp with their cards, so that the annual cost is reduced considerably.

There is another point. Logically, the amateur with the greatest amount of power receives the greatest number of cards. Again, if he can afford the power, the cost of acknowledging listeners' cards is small in proportion to his investment. The majority of amateurs get about as much thrill of knowing they are being heard as the SWLs get in receiving an amateur's verification.

Space did not allow (last month) of completing the data on the medium-powered transmitter described in the "Ham" Shack. Here it is:—To set the transmitter in operation, the filaments are lighted and the key circuit is closed. The plate power-supply is then turned on, but with the switches in the plate circuits of

the buffer and amplifier open. The oscillator tuning condenser is adjusted until a decided dip in the plate current is noted. This will indicate resonance. As a further check for oscillation, a neon bulb may be touched to the plate side of the tank circuit. Glowing indicates oscillation. The oscillator tank condenser should then be rotated several times to make sure that resonance always takes place at the same point. After making this check, the condenser capacity should be reduced slightly to provide for greater stability.

The next operation is to tune the buffer. The neon tube should be connected to the plate side of the tank coil, and the tank condenser tuned until resonance is indicated. It will glow brightly at resonance unless by chance the circuit is neutralized. Then the neutralizing condenser is tuned until the neon bulb stops glowing. The tank condenser should be rotated again to determine if there is any radio-frequency current in the tank circuit. If it does not glow, it indicates the buffer is neutralized. If it does, further adjustment should be made on the neutralizing condenser until a point is reached where there will be absolutely no indication of radio-frequency in the buffer tank circuit. This indicates proper neutralization. Then the switch in the plate circuit should be closed, and the buffer tank circuit tuned until the plate current takes a sharp dip. Minimum plate current indicates resonance.

So much for the buffer. Then the grid condenser in the final amplifier is tuned for maximum grid current. If a grid meter is not used, a neon bulb may be used to indicate when maximum radio-frequency is applied to the grid of the final amplifier. If a grid current meter is used, the grid current should be between 30 and 50 milliamperes. The final amplifier is then neutralized in the same manner as the buffer stage, and of course, with the switch in the plate circuit open and the key de-

PIONEER CSCG MEMBER

Young Jean Hudson obtained her amateur license (W3BAK) at the age of 8, becoming the youngest amateur in the world. At the age of 9, she entered the World-Wide Code Tournament at "A Century of Progress," Chicago, and in competition with 75 or 80 crack operators from all parts of the world, won the Official Championship of the World, in Class E, by turning out a letter-perfect copy at 20 words per minute on her "mill" for 5 minutes. Jean is on the QSO list of CSCG and can be heard almost any evening operating her station, W3BAK, Laurel, Delaware, on 3646 kc.

IN FAR-AWAY JAPAN

Notice the neat layout of this well-known Japanese amateur. He is Seichiro Handa, 18 years of age and operator of Station JIDM of Tokio.

pressed. After neutralization, the plate voltage is applied, and the tank circuit is tuned to resonance which is indicated by a minimum plate current. It should be between twenty and thirty milliamperes with 1,000 volts applied to the plate. Finally, the antenna is coupled to the plate tank circuit of the final amplifier and the antenna circuit tuned for maximum plate and antenna current. If the plate current is too high for the tube, the coupling between the tank and antenna coil should be reduced; if it is too low, the coupling should be tightened until the desired current is obtained.

The transmitter is now ready for operation. The key should be opened, and the plate and antenna currents should fall to zero. If this does not take place, more bias should be added on the final amplifier, until full cut-off is obtained with zero excitation.

For all-band operation, it is desirable to obtain crystals for 160-, 80- and 40-meter bands. On each of these bands, of course, the specified crystal is used. For 20-meter band operation, the 40-meter crystal should be selected to double into the higher frequency channel. The buffer-amplifier is then tuned to one-half the wavelength or twice the frequency of the crystal and is excited by the harmonic of the oscillator. This in turn drives the 211 tube in the 41,000-kilocycle band.

Much interest has been shown in the publication of pictures of amateur stations in this department. Owners of stations are invited to send in photographs of
(Turn to page 45)



**RADIO NEWS Sponsors
New Opportunity for
Code Practice at Home**

In June, 1933, there appeared an article in this magazine which announced a code guild for home practice. The following quotation is from that article: "One of the finest of short-wave activities, and one which will be of greatest interest and value to an enormous number of short-wave fans, 'hams' and prospective 'hams,' is found in the series of code-practice transmissions being put on the air regularly by members of the Candler System Code Guild, for the benefit of all owners of short-wave receivers who desire to learn to read code, or to brush up in cases where former ability to read code has become rusty from lack of regular and steady practice."

This Guild has been functioning for two years since that date and now, in order to increase its activities by making the service available to the many thousands of RADIO NEWS readers, schedules of code guild stations offering the code-practice transmissions daily will be published monthly in this space. A daily schedule is given for the present month (beginning June 4th and ending July 3rd). In the first column is the time (a.m. or p.m.); in the second column are the symbols E, C, M and P (where E is used for E.S.T., C for C.S.T., M for M.S.T. and P for P.S.T.). In the third column are the call-letters of the transmitters of amateur members of the Guild and the fourth column contains the frequencies of transmission in all cases, except where otherwise noted. Each CSCG transmitting station will begin his program at stated time by sending "CSG" 6 times, followed by his station call repeated 3 times, slowly. At intervals of 5 minutes, he will repeat "CSG" 6 times and his call letters 3 times. All who listen to CSCG programs are requested to write a card to the transmitting station telling him how his signals come in and, if possible, sending him copies of transmissions.

MONDAYS

6:30 A. E.	W1FNM	3510
6:30 A. E.	W2HJZ	3577
8:30 A. E.	W1AMH	3536 1/2 56100
8:30 A. C.	W9OKS	3777-7140
9:00 A. C.	W5BRT	14120
12:30 P. E.	W2CXD	3825
1:00 P. E.	W8GHP	3650
1:00 P. C.	W5BRT	14120
3:30 P. C.	W9TE	3506-7012
4:00 P. P.	W7WE	7274
6:00 P. E.	W1DUZ	3638-59000
6:00 P. E.	W8MHE	3610
6:00 P. C.	W9NIE	7220
6:00 P. E.	W8EEZ	3650
7:00 P. E.	W3AEJ	3785
7:00 P. M.	W7DAV	3810-3585
7:00 P. M.	W9HHW	7278
7:00 P. E.	VE2EF	3514
7:00 P. C.	W9LKK	3757
7:00 P. E.	W2HCP	3753-3835
8:00 P. C.	VE5IP	3700
8:00 P. E.	W8MCP	3620
10:00 P. E.	W8EEZ	3650

TUESDAYS

6:30 A. E.	W2HJZ	3577
8:15 A. E.	VE3UU	3865
8:30 A. C.	W9OKS	3777-7140
9:00 A. P.	W7AHG	40-80 meters
3:30 P. C.	W9TE	3506-7012
5:00 P. P.	W7WE	7274
6:00 P. C.	W9RPD	3574
6:00 P. E.	W8EEZ	3650
6:00 P. E.	W8MHE	3610
6:00 P. E.	W8KSG	3833-3790
7:00 P. E.	VE2EF	3514
7:00 P. C.	W9LUS	3631
8:00 P. C.	W5CPV	7149
8:00 P. E.	W8HKT	3750
8:00 P. E.	W8FYS	7035-7236
8:00 P. E.	W8MCP	3620
8:00 P. E.	W8FQS	3535-7134
8:00 P. M.	W7DBP	3607
9:00 P. E.	W8LZT	3825

WEDNESDAYS

6:00 A. C.	W5DDC	7200
6:30 A. E.	W1FNM	3510
6:30 A. E.	W2HJZ	3577
8:30 A. C.	W9OKS	3777-7140
9:00 A. C.	W5BRT	14120

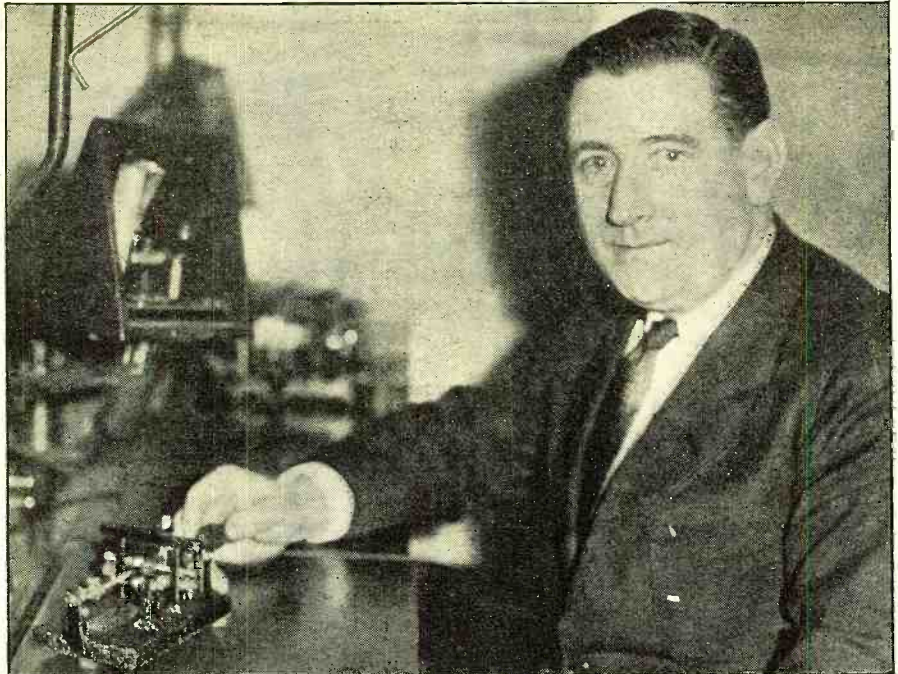

12:30 P. E.	W2CXD	3825
1:00 P. C.	W5BRT	14120
3:30 P. C.	W9TE	3506-7012
6:00 P. C.	W9RPD	3574
6:00 P. E.	W8EEZ	3650
6:00 P. E.	W8MHE	3610
6:00 P. E.	W8KSG	3833-3790
6:30 P. C.	W5BXA	3860
7:00 P. M.	W9HHW	7278
7:00 P. E.	W3AEJ	3785
7:00 P. E.	VE2EF	3514
7:00 P. E.	W2HCP	3753-3835.5
8:00 P. E.	W8FQS	3535-7134
8:00 P. M.	W7DBP	3722
9:00 P. E.	W8LZT	3825
10:30 P. E.	W2CRS	3475

THURSDAYS

6:30 A. E.	W2HJZ	3577
8:15 A. E.	VE3UU	3865
8:30 A. C.	W9OKS	3777-7140
9:00 A. P.	W7AHG	40 & 80 Meters
3:30 P. C.	W9TE	3506-7012
6:00 P. E.	W8EEZ	3650
6:00 P. C.	W9RPD	3574
6:00 P. E.	W8KSG	3833-3790
6:00 P. E.	W8MHE	3610
6:00 P. P.	W7WE	7274
7:00 P. M.	W9HHW	7278
7:00 P. E.	VE2EF	3514
7:00 P. C.	W9LUS	3631
7:00 P. C.	W9LKK	3757
8:00 P. E.	W8FYS	7035-7236
8:00 P. E.	W1AMH	3536 1/2 56100
8:00 P. M.	W7DAV	3810-3585
8:00 P. M.	W7DBP	3607
8:00 P. C.	VE5IP	3700
9:00 P. E.	W8LZT	3825
10:00 P. M.	W9CWA	3885

FRIDAYS

6:30 A. E.	W1FNM	3510
6:30 A. E.	W2HJZ	3577
8:30 A. C.	W9OKS	3777-7140
9:00 A. C.	W5BRT	14120
10:00 A. E.	W3AEJ	3785
12:30 P. E.	W2CXD	3825
1:00 P. C.	W5BRT	14120
3:30 P. C.	W9TE	3506-7012
5:30 P. C.	W9RPD	3574
6:00 P. E.	W1DUZ	3638-59000
6:00 P. E.	W8EEZ	3650
6:00 P. E.	W8MHE	3610
6:00 P. E.	W8KSG	3833-3790
7:00 P. E.	VE2EF	3514
8:00 P. E.	W1AMH	3536 1/2 56100
7:00 P. E.	W2HCP	3753-3835.5
9:00 P. E.	W8LZT	3825
10:15 P. E.	W4BHR	3867

SATURDAYS

6:30 A. E.	W2HJZ	3577
7:00 A. E.	W8ECY	7160
8:15 A. E.	VE3UU	3865
8:30 A. C.	W9OKS	3777-7140
3:30 P. C.	W9TE	3506-7012
4:00 P. E.	W3EIL	7088
6:00 P. C.	W9RPD	3574
6:00 P. E.	W8MHE	3610
6:00 P. E.	W8EEZ	3650
7:00 P. E.	VE2EF	3514
8:00 P. M.	W7DAV	3810-3585

SUNDAYS

6:30 A. E.	W2HJZ	3577
7:00 A. E.	W8ECY	7160

**Sets World Record
for Speed**

FASTEST Radio Operator of all time, T. R. McElroy, whose official receiving speed is 77 words per minute, says:

"In keeping with its constructive policy, RADIO NEWS has now taken another forward step by making it possible for every ham to have the right kind of practice through CSCG programs almost every hour of the day. The importance of this ought to be obvious to everyone when I say that I owe my speed and skill in the handling of code and the use of the 'mill' solely to C. S. training."

8:00 A. C.	W9GVP	3675-3900
8:15 A. E.	VE3UU	3865
9:30 A. E.	W8EEZ	3650
10:30 A. E.	W3EEY	3628
10:30 A. C.	W5DDC	7200
12 noon E.	W3EIL	7088
2:00 P. E.	W8KGM	3807
2:00 P. E.	W8KSG	3833-3790
2:00 P. P.	W6BTW	7145
1:00 P. C.	W9LKK	3757
3:30 P. C.	W9TE	3506-7012
6:00 P. E.	W8MHE	3610
6:30 P. C.	W5BXA	3860
7:00 P. E.	VE2EF	3514
7:00 P. E.	W1EAF	3610-7150
8:00 P. M.	W7DBP	3722
9:00 P. E.	W8LZT	3825

**Active Members
Candler System Code Guild**

W1DUZ	J. E. Vermeiren, 137 Middlesex St., Springfield Mass.
W1FNM	G. W. Wabrek, 25 Prospect St., New Hartford, Conn.
W1AMH	H. J. Morse, 48 Hebron St., Hartford Conn.
W2HJZ	Walter Germann, 905 E. 169th St., New York, N. Y.
W2CXD	Ray Cattell, Kiel Ave., Butler, New Jersey
W2CRS	R. W. Coffey, 640 Midland Ave., Yonkers, N. Y.
W2HCP	A. P. Blosser, 82 Dove Street, Albany, N. Y.
VE2EF	Leo LaCourse, 446 St. Roch St., Trois Rivieres, Que., Canada
VE3UU	Gordon Murray, 53 Elm Grove Ave., Toronto, Ont.
W3EEY	Dr. H. A. D. Baer, Baer Hospital, Allentown, Pa.
W3EIL	C. R. Martin, 2214-13th St., N. W. Washington, D. C.
W3AEJ	G. W. Knowles, 82 Elgin Ave., Westmont, N. J.
W4BA	Geo. G. Adams, Box 1055, Miami, Fla.
W4BHR	J. D. Randolph, Warren Plains, North Carolina
VE5IP	G. A. Playfair, Campbell River, V. I. B. C., Canada
W5BXA	Harold Trosper, Box 225, Whittenton, Texas

(Turn to page 45)

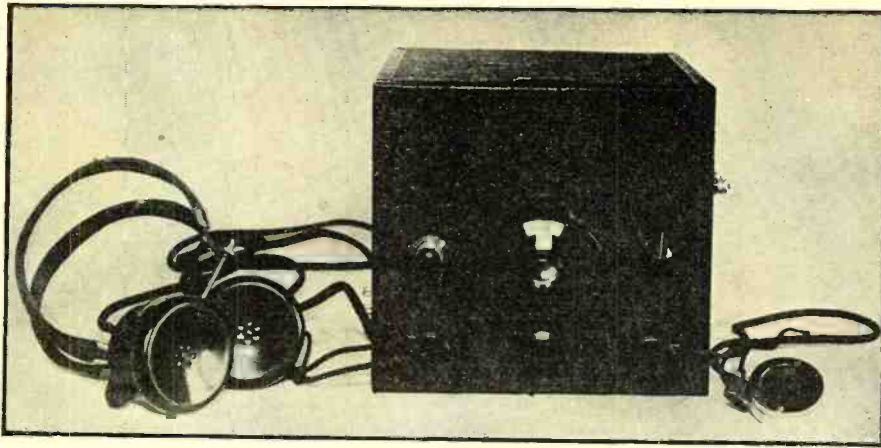

The "Acorn" Tube ON $3/4$ METER

(The Transceiver)

The transceiver described here is the third piece of "Ham" equipment built up by the author around the "acorn" tube. Previous articles described a $3/4$ -meter transmitter (May) and a $3/4$ -meter receiver (June)

Ed. Glaser*

Part Three

AFTER the preliminary experimental equipment had been built and tested (see the previous articles in the May and June issues) there was a need for a permanent, portable, shock-proof transceiver that could be easily installed in a car. The unit to be described has successfully filled the bill.

While it could have been made a great deal smaller the size is convenient, allowing plenty of room for making adjustments, and the popular type National case is well adapted to the layout.

Let us start with the wiring diagram, Figure 1. From left to right we see an antenna switching system with adjustable coupling in both "Transmit" and "Receive" positions, the 75 cm. oscillator (Gutton-Touly), other parts of the switching system and the audio stage. We will consider each item separately.

When a single tube is used for both detector and transmitting oscillator, especially when super-regeneration is being used, some arrangement must be made for securing optimum coupling to (loading of) the oscillator circuit. In many popular 5 meter "self-supering" transceivers no adjustment is provided, in which case coupling must be set correctly for the "Receive" position. This position requires fairly loose coupling in order to permit super-regeneration. When switched to "Transmit" position the coupling is too loose for proper power transfer—perhaps $1/2$ the output power is literally thrown away. In this

transceiver two coupling loops are provided which may be adjusted for best efficiency in "Transmit" and "Receive" positions.

The type of oscillator is the same as in the experimental transmitter and receiver previously referred to. It has proven itself well adapted to the acorn tube operating at 50 to 100 cm. as well as being the simplest circuit possible. No special parts are required, as in other circuits. L3 and L4, constituting the plate and grid "coils," are the pig-tailed leads of blocking condenser C1 cut to $3/4$ or $11/8$ of an inch. Although the oscillator was very well behaved in the previous two units it refused to get going in this new location. It was found that a little cathode impedance, L5, was

THE CIRCUIT DIAGRAM

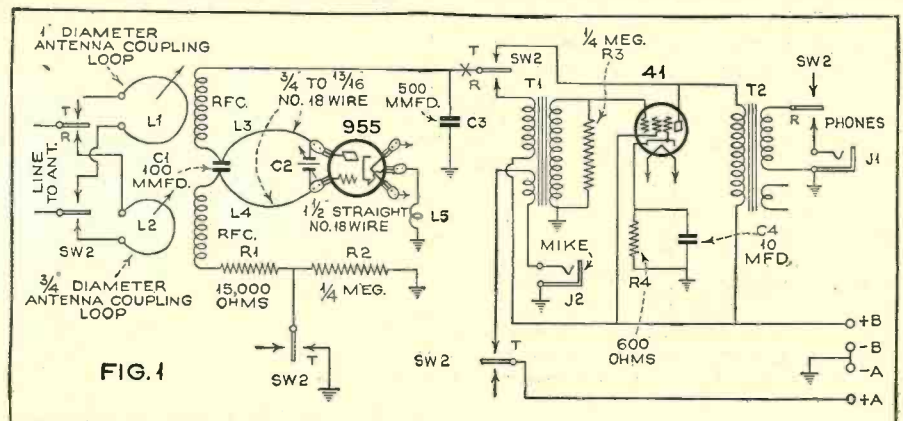

necessary to start oscillations, 1-inch of wire being satisfactory although $1\frac{1}{2}$ inches was finally used. The space between this wire and the sub-panel is fairly critical. A good deal of time was spent on the tuning system. The final arrangement is very satisfactory. A Cardwell Trim-Air condenser is stripped of all but two plates and these are spaced somewhat wider than originally. The stator plate is then cut in two leaving about $1/8$ inch between the halves. The cut edges are well rounded. The condenser is so placed that only $1/4$ inch of lead is used to the grid and plate terminals, connections being made *right at the tube, not on the circuit end of the socket terminals*. Such an arrangement permits a range of approximately 72 to 76 cm.

The transformer, T1, operates from the detector plate to the pentode grid in the "Receive" position and from the single button microphone to the audio grid in "Transmit" position. The transformer, T2, is a regular speaker output transformer in "Receive" position and serves as a conventional Heising choke when transmitting. Two secondaries are provided, a 2000-ohm phone or magnetic speaker winding, and a 10-ohm dynamic speaker winding. The 10-ohm output could be made to feed a low impedance phone and has been so used with very satisfactory response.

There is plenty of leeway allowable in constructing this transceiver. However, certain rules must be obeyed. The Cardwell condenser must be placed just above the grid and plate terminals to permit the very necessary short leads (remember—the inductances are $3/4$ -inch wires) and to get it out of the field of the single turn circuit as much as possible. The photograph cannot tell the whole story but can be useful. Note that the acorn socket "sits" on the sub-panel and supports the loop. A large hole is cut out of the sub-panel to allow plenty of "breathing space" for those valuable 75 cm. milliwatts. The mica-lex socket, although a very low-loss support, is slit with a hack-saw between grid and plate just in case . . . and no sacrifice is made in mechanical strength. The socket being right on the sub-panel and the condenser being just above it, the shaft and dial positions are fixed, no alteration being permissible. The Yaxley switch must be close to the antenna lead-in bushings and must be so placed that the leads are short and direct to the coupling loops. This makes

* Amateur Station W2BRB.

for a neat system with not too much stray field. Porcelain insulators (the same as the lead-in bushings) take the 4-loop leads through the sub-panel. The r.f. chokes should be directed away from the oscillating coil and supported on tiny insulators. The small wire used hasn't much mechanical strength but cannot be made larger for fear of increasing the distributed capacity and thereby reducing the choking action.

In conventional apparatus the single point grounding system is considered best practise. At these frequencies, however, this is not necessarily true because the length of lead necessary to reach that common ground point may act as a series choke—and does! The point where the cathode lead is attached to the base is made the pseudo-common ground point. Holes are drilled under the cathode and heater prong screws to prevent any grounds at these points. All wiring, except leads to the switches, is put beneath the sub-panel. Wires in the vicinity of the oscillating circuit are as short as possible and run right against the sub-panel as a protection against interaction. The 41 socket could have been sub-panel mounted. In mounting the micro-mite insulators it is well to put paper or lead washers under them to prevent cracking when mounting.

While this outfit was supposed to be used with a 6-volt storage battery and 135 to 180 volts of B battery, the heaters may be run from a 6.3-volt a.c. source and the plates from any suitable B supply, vibrator or a.c. type. The microphone must then be fed from a separate source which may be a 4½-volt C battery. It is important to use a plate milliammeter while tuning up and the meter might well be retained. It should show only the 955 plate current rather than the total B battery drain, and should be connected at point X in the diagram. After testing the filament circuit, the heater switch should be opened and the B supply connected. Now turn on the heaters again and watch the plate meter. In the "Transmit" position, it should rise and then dip sharply once, while in the "Receive" position, it should dip twice, indicating super-regeneration. This is very im-

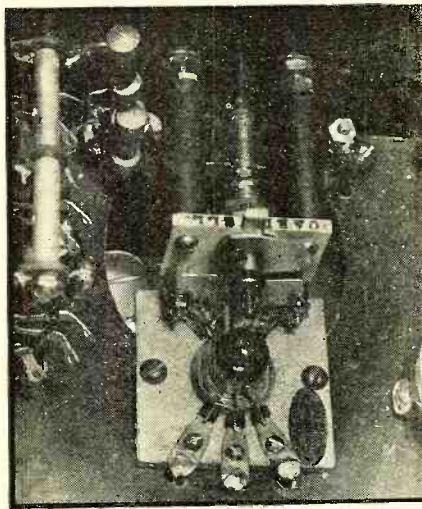

CLOSE-UP UP TUNED CIRCUIT

portant. The test should be made with the antenna connected as the loading will have a great effect. While there is little trouble in getting the set working, many hours can be spent on any 75 cm. rig in squeezing out every bit of power available and in tuning the antenna, or tuning the set to the antenna and getting proper coupling in both positions. A Yagi or other directional antenna such as described in last month's RADIO NEWS might as well be used at first, although until some Lecher wire wavelength measurements are made, a 14-inch antenna fed by a 2-wire line spaced about 1-inch will suffice. The line should be tapped on the antenna about 1½ inches each side of the center, forming a "Y" type impedance match.

In the "Receive" position two adjustments can be made to get the familiar rushing sound of super-regeneration, the length and position of the cathode impedance wire and the amount of antenna coupling. The coupling should be increased until the smooth hiss gets rough, then decreased slightly. The hiss may not be uniform throughout the frequency range but should cover a large portion of the dial. Now investigating the "Transmit" position, watch for that second dip! If it occurs, increase an-

tenna coupling. If this won't cure it maybe some antenna adjustment will. As a last resort, decrease the transmitter grid leak to 10,000 ohms. When testing for oscillation, the plate prong will be "hotter" than the grid prong, hence touch the plate prong with the finger and watch for a rise in plate current.

The frequency should be adjusted by varying the length of L3 and L4, ¼ of an inch at a time! In the "Receive" position, couple a pair of Lecher wires, (described in the May and June issues) to the oscillating circuit very loosely so as to introduce as little error as possible. The antenna should be connected. Slide a rigid bar along the wires and note the points at which the rush is reduced. The distance between two such points is ½ wavelength. The tuning range should be found while the Lecher wires are connected. If it exceeds a few centimeters, it might be well to increase the condenser plate spacing, for there is no need to cover a lot of territory and make adjustments harder. A variation of frequency when shifting from "Transmit" to "Receive" position can be compensated for by sliding the coupling loop of the higher frequency circuit toward the high r.f. voltage part of the circuit (toward the tube) and so introducing a proper amount of capacity coupling. This can be done without changing the amount of total coupling although a few trials may be necessary.

A volume control may be used across the secondary of T1 in place of the ¼-megohm fixed resistor if a pair of headphones are used. With a handset, it is unnecessary. If the microphone gives too high a level on 6 volts, the voltage may be reduced, a few hundred ohms may be used in series or the mike may be fed to a 400-ohm potentiometer connected across the transformer input. The completed transmitter may be tested by using a crystal detector (of 1920 vintage) across a pair of phones, a short wire connected to the crystal being placed near the antenna. The receiver may be tested by listening to car ignition or, better, by picking up harmonics of a nearby 5-meter transmitter—or even a 20-meter phone. Of course, a single transceiver (*Turn to page 55*)

TOP VIEW

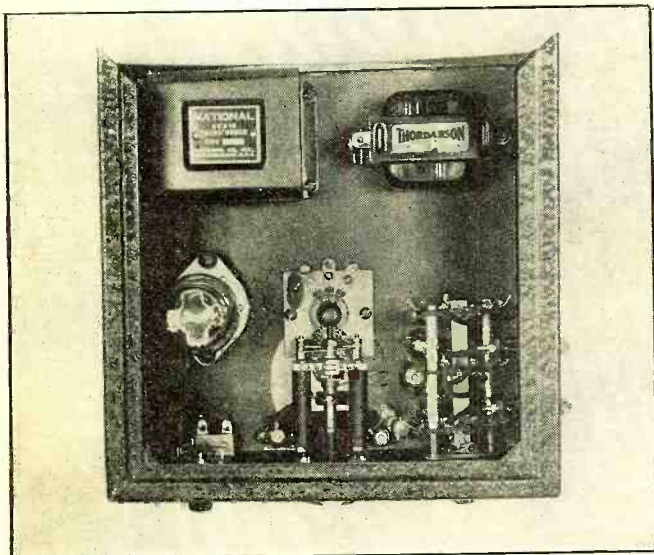

BOTTOM VIEW

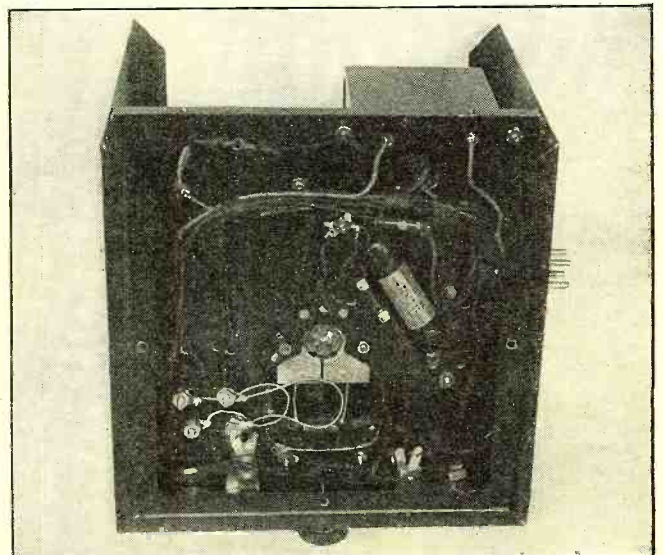

EDUCATION

"MAKING



MAKING RADIO ENGINEERS

Studying modulation with an oscillograph at C.R.E.I. Below: class at the National Radio Electrical School.



WE would venture to define the engineer as a practical technician who possesses a thorough insight into the science in which he specializes, and into closely related sciences. By a thorough insight, we mean a fundamental—a mathematical insight.

THE natural phenomena which underlie all sciences can only be perfectly understood, controlled and operated upon, by mathematical dissection. It is not sufficient to appreciate the simple arithmetical fact that to secure the greatest power output from a given "machine"—from an electric motor to a vacuum tube circuit—that the load impedance must be equal to the internal impedance. The fundamental mathematics of maxima and minima must be understood to remove the last vestige of parrot-like comprehension, so that the theory may be applied to different but analogous conditions.

You may be told that higher mathematics are not essential, that they are never employed in every day engineering, and that the college trained engineer

WORKING "ON HIS OWN"

The student getting the "feel" of modern broadcast equipment under the eye of a Coyne School Instructor.



The Radio Engineer

How to get the training necessary to secure and hold the position you want in radio. This month's installment includes the general problems of student engineers who have written to the Editor for advice.

forgets his math in the first year out of college. Such statements are particularly insidious, because they sound logical enough, and have in them some element of truth. No mind or memory is perfect. Something must be forgotten.

The point is, that some math is necessarily forgotten. Hence the desirability of a bit of surplus. But no engineer ever forgets his essential math. Any engineer, worthy of the name, keeps up-to-date by reading his journals, technical papers and attending engineering meetings. And the engineering presentation—aside from occasional non-technical papers—that can be assimilated without knowledge of calculus and the mathematics of complex quantities (which involve imaginaries) is rare indeed. As a matter of fact, no real engineering text, the comprehension of which is essential to engineering students, can be intelligently studied without a thorough groundwork in higher mathematics. The prospectus of the R.C.A. Institute courses in mathematics rightly observes that—The mastery of calculus stamps the student as ready to be an engineer rather than an ordinary technician.

If you would be an engineer, you simply cannot get away with the mathematics that suffice for servicing and operating jobs. This does not mean that various "engineering courses," which imply that higher math is not essential, do not provide engineering training. They may merely be deficient in this one respect, and the desideratum must be compensated by the student by independent and outside study of higher mathematics.

Having established more or less of a definition of what constitutes an engineer, we may consider the methods by which the student attains that dignity. Most of our engineers are college-trained men, and there are very few persons who will not concede that the standard 4-year college course, with the usual majoring, provides the best primary training for the engineer. Such courses are thorough, the student is not rushed, he is given an excellent and highly desirable general science background, while math is even more than

for A LIVING in RADIO"

Zeh Bouck

Part Three

adequately covered in the curriculum.

It is maintained, by many, that our average 4-year college course features curricula not at all essential to the engineer and by eliminating the same, an adequately-trained engineer can be turned out in two years—as is done in some colleges. True enough—but such subjects as foreign languages, medieval history, economics, English literature, etc., if they can be afforded, should not be discarded as “unessential.” The engineer has an excellent start toward the attainment of any heights to which he may aspire. In the process of his advancement, and in the maintenance of his ultimate status, he will be confronted with social and cultural problems as well as technical ones. Successful engineers are usually men of versatile accomplishments, whose imaginations are by no means circumscribed by a book of log tables or the slide-rule. Many of them can tack a Ph.D., along with lesser degrees, after their names.

Degrees are conferred on the completion of all 4-year college courses. While there are many engineers, fully worthy of the name, who do not possess this distinction, the degree is a genuine attribute. True, alone it cannot make a good engineer, but it immediately identifies the possessor as one who has been adequately trained. It is a matter of credential, which facilitates the securing of a position and the entrance to the higher grades in engineering societies.

The 4-year college course is recommended only to the youthful student, fresh from preparatory school. He should take the science course, and major in electrical engineering. Upon being graduated he will be entitled to either a B.Sc. or an E.E. degree—or both. To the best of the writer's knowledge, no college gives a degree of “radio engineer.” However, the electrical engineering student, desiring to specialize in radio, is usually permitted to devote his last college year to the study of that branch of electrical science.

No specific recommendation of colleges can be made. The college is always a matter of convenience, personal inclination and finance. In passing, however, it may be said that there are colleges giving free engineering courses and scholarships are available for practically all universities. Arrangements can occasionally be made whereby the student can work for part, or all, of his tuition.

For the man who is already established in the radio field—an ambitious serviceman, for instance, who has saved or otherwise acquired sufficient financial resources—and who desires to progress in the engineering direction, a two-year course, such as those provided by Tri-State College and Indiana Tech, is highly recommended. While the entrance requirements normally stipulate high-school graduation, it is not absolutely essential, providing the student is willing to make up the deficiency by taking extra courses. Students may matriculate at the beginning of any of the four annual terms—winter, spring, summer and fall. These courses provide an excellent general science background through the study of physics and chemistry, and the student is carried well into the intricacies of differential equations. Upon graduation, a degree of Bachelor of Science in Radio Engineering is conferred. It is estimated that \$1500.00 should see the economical student through the entire two-year course—covering living expenses, tuition, incidentals and a reasonable amount of recreation.

For the student (Turn to page 57)

GETTING LAB PRACTICE

This is the transmitting laboratory, containing various types of modern transmitters, at the RCA Institutes.

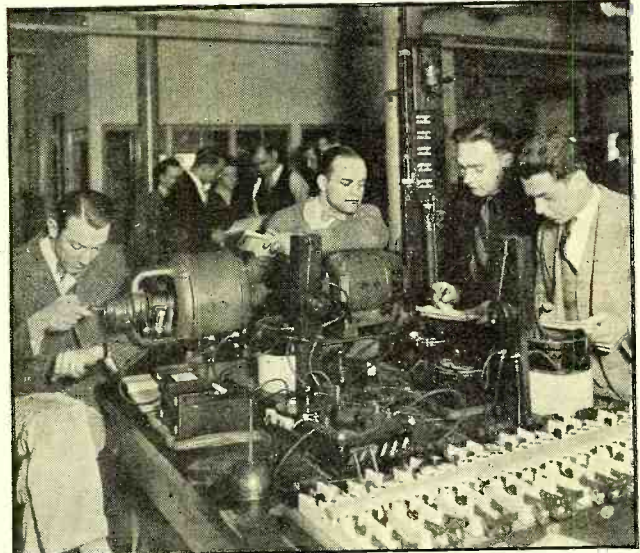

LEARNING THE FUNDAMENTALS OF RADIO

Getting an insight into the electrical phenomena underlying Radio engineering, at the Bliss School. Below: a set-up at Port Arthur College, where the student operating-engineer learns his “stuff” from practice as well as from theory.

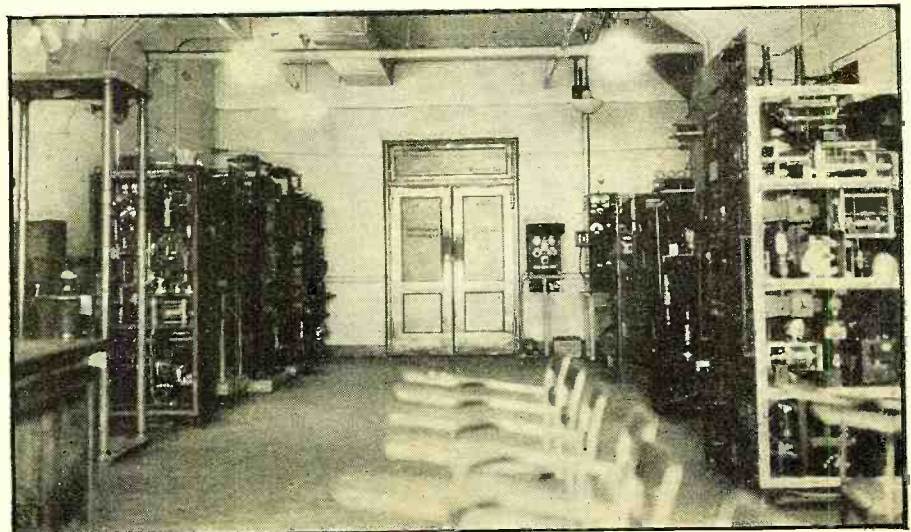
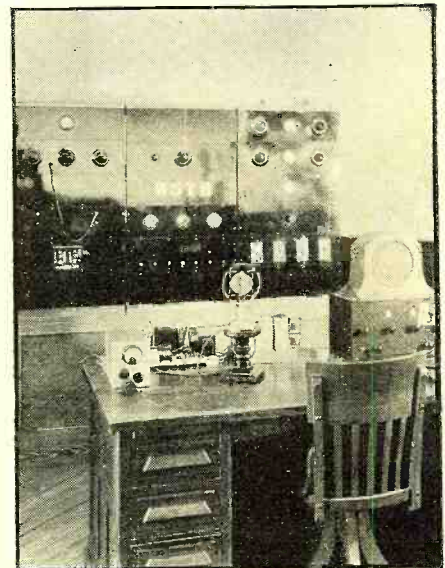

How to Build the "PERPETUAL" TUBE CHECKER

Verne V. Gunsolley
Part Two

IN the previous installment the principles of the tube checker were discussed and the article closed with the details of the automatic switch. Now we continue with the construction data on the co-ordinate switching system.

IF the tester is to be used for rack-and-panel mounting, a larger panel than specified will be used, giving plenty of room for the switch assembly. In this case considerable labor may be saved by using ordinary toggle switches for contactors here described. Figures 2, 3, 6, 7 and 8 are to be studied for this description. To make the keys, 1/4-inch bakelite rod is cut up into 3/4-inch lengths, rounding and polishing one end before cutting each. For 1/8 inch from the opposite end each key is filed down 1/8 inch on opposite sides, as shown in the detail of Figure 8. A 1/8-inch hole is drilled 1/8 inch from the polished end. Cut 24 lengths of hard drawn No. 16 copper wire. Insert one in the hole of each key and with the wire projecting equally from both sides, bend around the key in opposite directions so the wire forms an S shape. This wire forms a pin and bearing to prevent the key slipping out of the panel and is shown plainly in Figure 8 between the panels on all keys.

Put a sheet of writing paper between the 7- by 10-inch panel and the 6 3/8- by 2 3/4-inch subpanel to keep them from slipping and clamp them together with C clamps in the position shown in Figure 8. Drill all the keyholes with an F drill (.257 inch), also drill the four corner holes for the 6-32 oval-head mounting screws. Remove the sub-panel now and drill the holes for the terminal screws. These should be just large enough so that the round-headed 4-32

brass screws will form their own thread; that is, just screw in snugly without necessity of threading the hole. Put 3/4-inch screws in all these holes, which are indicated by the small open circles, Figure 8, and which form the vertical-bus terminal posts, and put 1-inch screws in all the holes indicated by the small closed circles. To these 1-inch screws the spiral ends of the contact springs are heavily soldered, and they form the horizontal bus terminal posts. Use No. 16 hard drawn copper wire for the busses and solder to the screw ends as shown, thereby forming the horizontal and vertical busses shown in the figures. There is insufficient room for the end terminal posts as seen at the bottom of Figure 8. Simply drill a hole here to fit the bus wire, insert it and bend over as shown. The photographs show the entire construction of this tester to have been by this method. In place of screws, the bus wire was used, drilling the panel for a force fit. This requires a little more patience but is just as good. The contact springs are formed on a fixture made of nails driven in a board so that after the wire is wrapped around them it assumes the proper shape when released. The wire is No. 22 phosphor bronze. (No. 20 is satisfactory, but No. 22 is large enough and gives easier operation of the keys.)

After the sub-panel is complete and the busses and springs installed, insert

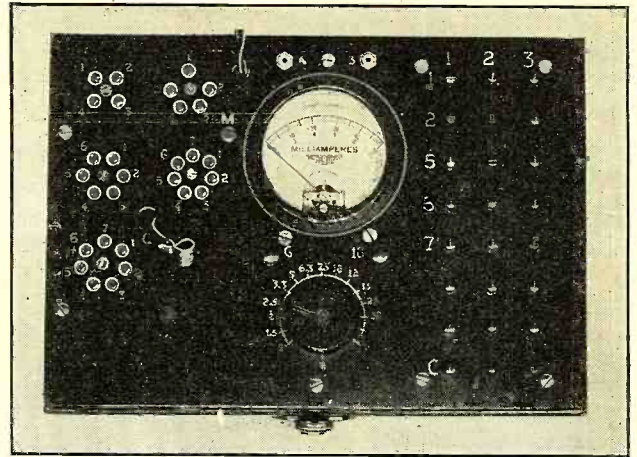

PANEL VIEW

Figure 6. In order to save space, the sockets are of the wafer type, cut down and mounted with but one screw; home-made keys, as shown in Figure 8, are used for switches.

all keys in the sub-panel and then place in the main panel, with one 6-32 nut used on the corner mounting screws as a spacer. With all keys in the open position, engrave vertical lines and fill with white wax or paint as shown in Figure 6. When the key is closed, the vertical line turns horizontal, indicating contact. Figure 8 shows the same keys closed as in Figures 6 and 4 (in the previous installment) by the heavier lines representing the springs.

The transformer is of the conventional type offered by several manufacturers for the purpose. The filament readings appear on the face of the panel shown in Figure 6.

The meter used in this tube checker was a dual-range milliammeter with ranges of 0-10 and 0-50 ma. The button "10" serves to cut out the shunt. The reader could employ a single-range 0-10 milliammeter and make his own shunt for the 50 ma. range.

Test Data

The readings for the various tubes are not given, as they will vary with the type of equipment with which the tester is constructed. Usually the constructor will make (Turn to page 58)

SWITCH WIRING

Figure 7. The actual arrangement of switches. Constructional details are shown in Figure 8.

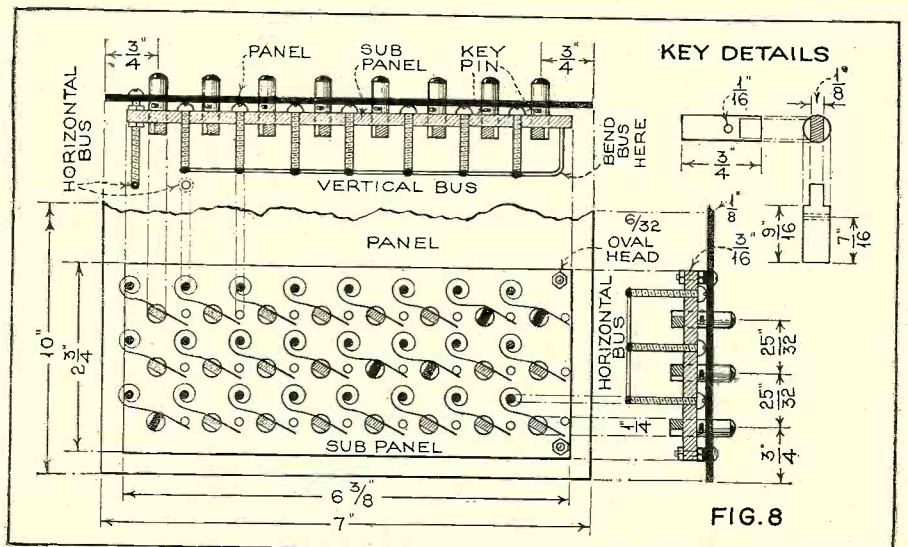
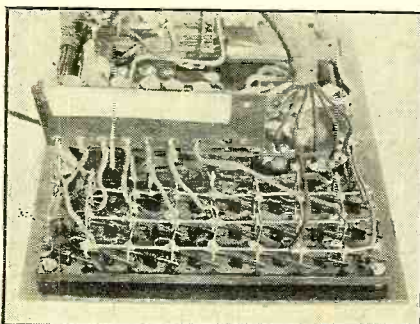
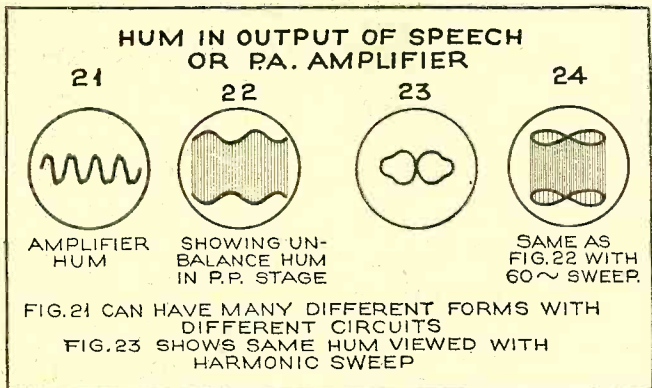

FIG. 8

Using the CATHODE-RAY OSCILLOGRAPH (Analyzing Distortion and Hum)

Kendall Clough

Part Three



IN previous installments (May and June issues) the author explained the fundamentals of the cathode-ray oscilloscope and showed the traces of perfect sine waves, with a linear and with a harmonic sweep. This third part tells how the cathode-ray tube is used to analyze distortion in amplifiers and to trace hum.

CONNECTING the output of the amplifier to the vertical deflecting plates and employing a linear sweep circuit, adjust the sweep frequency to one-half the frequency of the signal passing through the amplifier, then turn the potentiometer up until the pattern takes on one of the form shown in Patterns 13 to 15. These are the distorted forms of the pure sine waves shown in Pattern 6 last month.

Three common cases of distortion are illustrated by these patterns. Pattern 13 shows flattened crossings at the zero of the wave and is commonly formed with an amplifier of the Class B or AB type in which the bias shifts to a value too high when driven to full output. With this abnormally high bias, the zero of the wave is passed by the signal voltage below the plate-current cut-off, or so low that the slope of the plate-current voltage is less than normal. This results in the plate current not rising in proportion to the change in grid voltage over a small interval.

Pattern 14 shows an amplifier in which a single-ended tube is incorrectly biased, or is too small to carry the signal voltage at full output. Note that the wave is sinusoidal on the lower side and cut off on the upper side. With such a pattern it sometimes is helpful to remove the upper plate of the oscilloscope from the output stage and connect back to the preceding plate circuit in order to locate the offending stage.

Once located, it is a guess, with a pattern such as this, whether the flattening of the wave was due to too little bias, causing the tube to draw grid current on positive peaks; or too much bias, causing the plate current to swing below cut-off on negative grid peaks. A slight

readjustment of the bias one direction or the other will determine which cause is responsible.

Pattern 15 shows a flattening on both positive and negative peaks. This may be caused by one of several circuit defects, but is most likely in a push-pull stage. This pattern, in comparison with Pattern 14, illustrates an important rule to bear in mind: In general, distortion exhibited on one side of the wave indicates circuit difficulties in connection with a single-ended amplifier stage, while distortion which is symmetrical on both sides indicates circuit difficulties in a push-pull stage.

Thus Pattern 15 might be caused by a push-pull stage improperly biased so that grid current was drawn by one tube on each half cycle, or it might be due to a Class B stage operated from a power supply of such poor regulation that adequate voltage is not supplied for the peaks of the cycle. It could also be due to incorrect driver transformer ratio. The important point is that the difficulty is indicated and the results of each circuit change can be observed on the screen of the cathode-ray tube.

It is a little more difficult to recognize the various forms of distortion when the linear sweep is dispensed with and the harmonic sweep is used. With a little careful analysis, however, all forms of distortion can be detected. By way of illustration, the distortion Pattern 15 has been redrawn in Pat-

terns 16 to 20 to show how this distortion appears for various phase relationships between the input and output voltages of the amplifier.

By comparison of each of these patterns with those shown last month, the effect of distortion on the pattern as observed with the harmonic sweep will be made clear. In some similar manner, the types of distortion in Patterns 13 and 14 will reshape the true straight line, ellipse or circle which should show on the screen if there is no distortion in the amplifier.

Hum can be observed with the linear sweep circuit. It is convenient to connect the control circuit of the sweep to the power line in order to maintain a constant pattern. The input to the amplifier is now reduced to zero. Due to the many circuit elements in an amplifier which contribute to the hum, particularly in high-gain types, the hum output is seldom a simple sine wave, but is usually more complex. Pattern 21 illustrates such a hum with the sweep rate set at 60 cycles. Note that at this sweep rate the trace crosses the zero axis four times, indicating that the principal component of hum is 120 cycles. This is evidence that the hum is probably set up in a poorly filtered full-wave rectifier circuit or is caused by induction from a power choke to an input transformer. 60-cycle hum would be traceable to a poorly filtered half-wave rectifying circuit or to induction from a power transformer to the input circuits.

The same type of hum pictured in Pattern 21 with the linear sweep would appear as Pattern 23 if the harmonic 60-cycle sweep were used. Here the "figure 8" characteristic indicates that the basic hum frequency is 120 cycles. A distorted closed single loop would indicate a strong 60-cycle component of hum.

Measurements across the filter condensers of a power pack can frequently give desirable information when made in this same way. For this, a condenser of proper voltage (Turn to page 60)

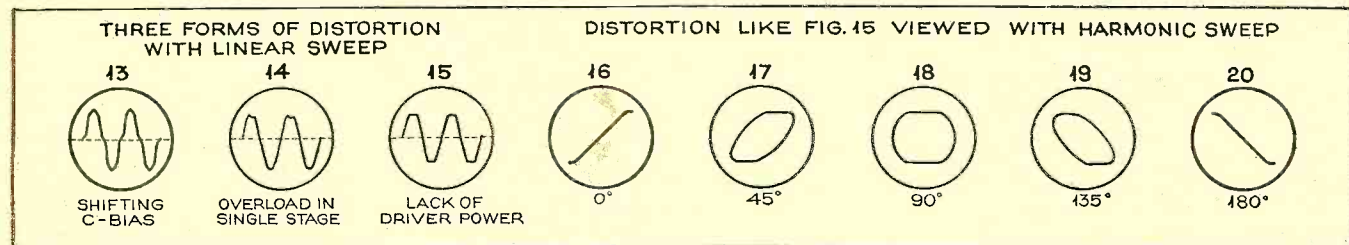

For Servicemen—A New ALL-PURPOSE TESTER

(Supreme "385 Automatic")

Floyd Fausett

Part Two

A SIMPLIFIED arrangement of the "Quality Test" tube-checking circuit of this instrument is indicated in Figure 7, in which it is observed that the direct current passed by the tubes is measured by one of the meters, and that the current is limited by the tubes and by the resistors R1, R2 and R3. The value of the resistor R2 is predetermined for each type of tube, and the corresponding control-knob setting is included in a "Tube List" card which accompanies each tester. The resistance values are determined by the factors of (1) the range of the internal tube resistance values, (2) the necessity of protecting the meter against short-circuited tube overloads, and (3) a desirable ballast effect to minimize the slight variations which may exist between different brands of tubes. The circuit constants are such that all tubes are tested at more nearly normal rated loads than is usually the case with commercial tube testers, thereby assuring a correspondingly greater degree of accuracy in the classification of tubes.

The "grid shift" method of testing tubes is well known, as it has been used for several years. It is wrong, however, to refer to a "grid shift" test as being a mutual conductance test, unless rated d.c. potentials are applied to the tube during the tests. Any variation from rated d.c. potentials will produce corresponding variations in mutual-conductance ratings. This is proved by a casual observation of a table of tube characteristics such as that published by any tube manufacturer. An actual mutual-conductance tube tester, made up as a single unit, would be quite complicated in its design and operation and would be too expensive for practical commercial purpose.

The high cost and operating complications of a true mutual conductance tester have resulted in efforts on the part of testing equipment design engineers to make such compromises as are necessary to strike a balance between absolute accuracy and practical utility. Such a practical compromise involves (1) a commercially acceptable selling price, (2) a reasonable degree of simplicity of operation, and (3) a practical degree of accuracy. This results in a departure from the use of the various rated d.c. values to a compromise of a few average values which can be supplied to all tubes alike, thereby lowering the number of controls and providing the desired elements of relatively low cost and

simplicity of operation, with an accuracy in the order of 90%.

The "grid shift" tester with its compromise of applied potentials was simple enough until the sudden avalanche of about 150 types of new multiple-element tubes, when the simple "grid shift" tester had to take on a larger number of sockets, or a larger number of controls, or both, with additional compromises in accuracy. It was then that the design engineers began to study the possibilities of other types of testers which could be designed to combine operating simplicity with practical accuracy.

As a result of the practical necessity for eliminating the "grid shift" tester for general tube-testing practices, the emission tester came into favor, because it was found that a well-designed emission tester is more accurate than a poorly-designed "grid shift" type. After all, about all that can happen, within the realm of probability, to a radio tube after the tube is placed in service, is a depreciation of the emitting qualities of the cathode element, so why not test a tube by measuring the emission current?

It is the purpose of Figure 8 to indicate the circuit arrangement for indicating leakage between the heater and the cathode, or one of the other elements of a tube. It is observed that a 110-volt a.c. potential is applied in series with a neon glow lamp, a blocking capacitor, C1, and the tube under test. A tube cannot rectify the applied potential because of the blocking capacitor (C1), which will not allow a continuous passage of unidirectional current, but which will pass alternating current only. However, an alternating current cannot pass through the tube unless there be leakage through it, in which case the neon glow lamp will indicate the passage of a.c. leakage current by a glow of both elements of the neon lamp.

The reader may now ask the purpose of the C2 capacitor in Figure 8, and the answer is found in the fact that the sensitive neon glow lamp would indicate leakages far beyond the permissible range of leakages if some means were not provided for reducing the sensitivity of the lamp. This is done by means of the C2 capacitor in parallel with the lamp.

It is generally agreed that a leakage resistance value below 100,000 ohms between the cathode and the heater elements is detrimental (Turn to page 58)

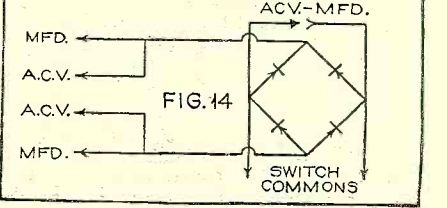
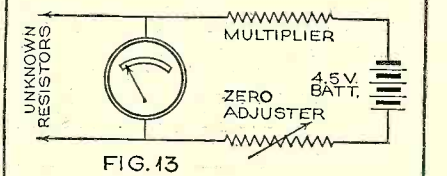
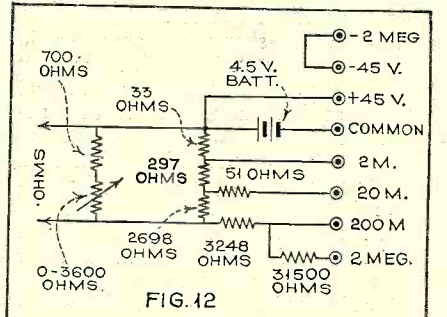
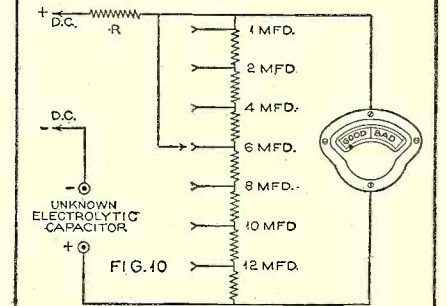
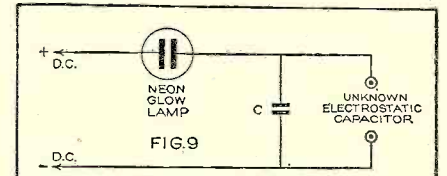
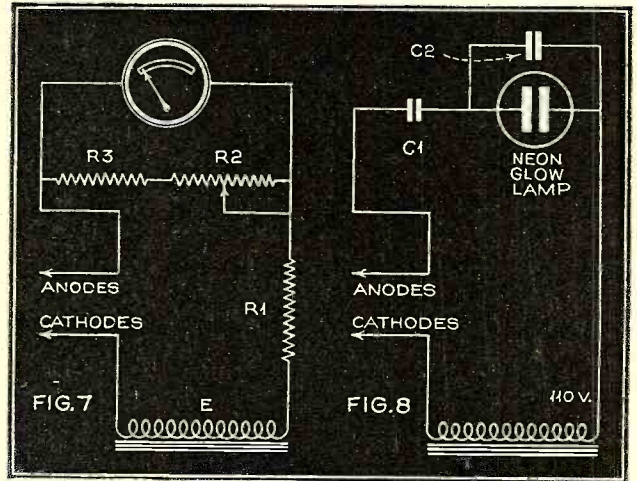

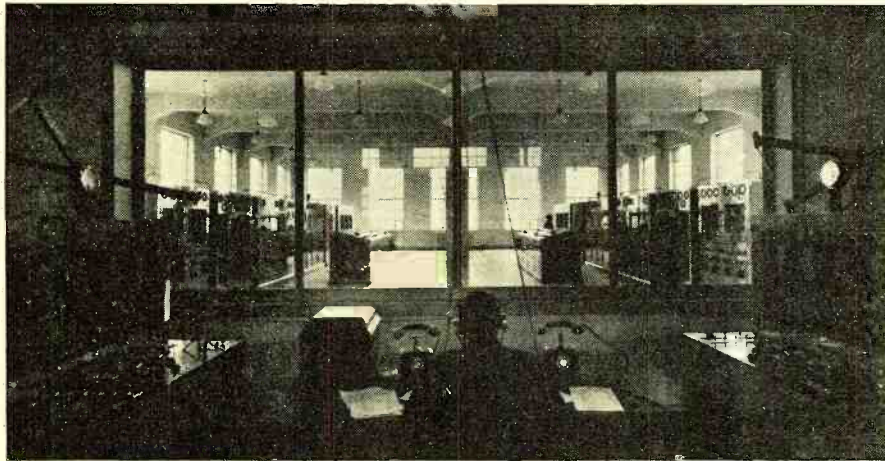

BRUSSELS 2
The transmitter and control room of the famous Belgian station offers an excellent example of modern European transmission equipment and layout. An outside view of this station is shown on the next page.

Photos courtesy Observer P. H. Robinson

THE DX CORNER

(For Broadcast Waves)

S. GORDON TAYLOR

THE short waves offer broadcast-band DX'ers an opportunity for a great deal of enjoyment during the next few months. For the most part, broadcast band DX is out of the question, but on the other hand, short-wave reception will be at its peak during the summer months. If you have an all-wave receiver, play around with its low wave ranges. You will find the short waves more interesting than ever before. If you do not have an all-wave or short-wave receiver, the RADIO NEWS Short-wave Converter, which was described in the April, May and June issues, is inexpensive and can be hooked ahead of your broadcast-band receiver with exceptional results.

Tuning the Antenna

The attention of all broadcast-band DX'ers is called to the article on the RADIO NEWS Trap-circuit Tenatuner described in this issue. This unit is simple and inexpensive to build, will function either as an antenna tuner or a wave trap, and will provide a surprising increase in signal

strength on weak DX stations. Hooked ahead of your broadcast receiver, it will in many cases provide loudspeaker reception of stations which otherwise would be barely audible—if at all.

Register of DX Clubs

As announced last month, this department will be glad to run a monthly Register of DX Clubs. Club executives are invited to submit information on their organizations, for publication.

That Mystery Broadcast

Some months ago a "mystery" broadcast was announced to take place on March 17th. No information was given on the station except that it was one which had never been reported by an American listener. Between the date of the announcement and the date of the broadcast there were rumors afloat to the effect that the broadcast had been called off. It now appears that the broadcast did take place as scheduled. Two of our Observers have written in concerning it.

Observer Kalmbach (New York) writes: "Here's the information I have concerning the Mystery DX which took place March 17th from 4:13-5:47 a.m., EST. Reports were received from New York, New Jersey, Connecticut, and several other cities, but the location of this station will remain a mystery. The only way anyone will ever know the location of this station will be if Mr. 'X' tells."

Observer Botzum (Pennsylvania) writes: "In the June issue of RADIO NEWS I read Observer Kocsan's (Pennsylvania) report, and noticed his question regarding that 'mystery' station DX broadcast scheduled for Sunday, March 17th. Also read your Editor's Note regarding same. That same morning, Sunday, I had very good reception, so I tried for that 'mystery' station—although I had read in my Canadian DX Relay Bulletin that program was off. But at 4:19 a.m. I really believe I had it."

"This station was received on about 985 kc. and was held until 4:31 a.m. EST at R4 and QSA2-3. The program I heard featured a man singing (in English) and was accompanied by guitar or mandolin music. After each selection the announcer and singer talked together. Once the announcer gave the location and call letters. While this was too weak to understand, the last word he said was 'America.' I tried my best to get the location, etc. It simply couldn't be done. I can't figure what station that was. I had it announced over Station KDKA DX period by Joe Stokes but so far no other DX'ers has replied to my report over KDKA. Perhaps you have received other reports on this broadcast. I thought I would write you about my reception regarding that 'mystery' anyhow."

Apparently this station remains a "mystery" station. This is unfortunate because there were undoubtedly many DX'ers who tried hard to hear this station and it seems only fair that in return for this effort they at least should have the satisfaction of knowing who the station was. For these listeners, this episode carries all the dis-

AN ILLINOIS LISTENING POST

Observer Ray E. Everly and his Scott '31 super. Above he poses with his mascot—perhaps it's a DX hound.



Official RADIO NEWS Broadcast Band Listening Post Observers

United States

- California: Roy Covert, Bill Ellis, Randolph Hunt, Warren E. Winkley
- Connecticut: Fred Burleigh, James A. Dunigan, Philip R. Nichols, R. L. Pelkey
- Georgia: W. T. Roberts
- Illinois: Herbert H. Diedrich, Ray E. Everly, H. E. Rebensdorf, D. Floyd Smith
- Indiana: E. R. Roberts
- Iowa: Lee F. Blodgett, Ernest Byers
- Kansas: Vernon Rimer
- Maine: Danford Adams, Steadman O. Fountain, Floyd L. Hammond
- Maryland: Louis J. McVey, William L. Bauer, William Rank, Henry Wilkinson, Jr.
- Massachusetts: William W. Beal, Jr., Walter C. Birch, Russell Foss, Simon Geller, Robert A. Hallett, Evan B. Roberts
- Michigan: John DeMyer, Howard W. Eck
- Minnesota: F. L. Biss, Walter F. Johnson
- Missouri: Dudley Atkins, III.; T. E. Gootee, C. H. Long
- Montana: R. W. Schofield
- New Jersey: Henry A. Dare, Jack B. Schneider, Alan B. Walker
- New York: Jacob Altner, Ray Geller, Edward F. Goss, Robert Hough, Robert Humphrey, John C. Kalmbach, Jr., Harry E. Kentzel, Maynard J. Lonis, R. H. Tomlinson
- North Carolina: Marvin D. Dixon
- North Dakota: O. Ingmar Olsson
- Ohio: Stan Eicheshen, Donald W. Shields, Richard J. Southward
- Oregon: David Hunter, Walter Weber
- Pennsylvania: Robert W. Botzum, Robert Hoffman Cleaver, Edward Kocsan, J. Warren Routzahn, Joseph Stokes
- Texas: E. L. Kimmons
- Virginia: C. C. Wilson
- Washington: John Marshall, Junior High School Radio Club
- West Virginia: Clifford Drain
- Wyoming: J. H. Woodhead

Foreign

- Alaska: S. A. Tucker
- Australia: Albert E. Faull, Victoria; George F. Ingie, New South Wales; Aubrey R. Jurd, Queensland
- Canada: William H. Ansell, Saskatchewan; C. R. Caraven, British Columbia; Claude A. Dulmage, Manitoba; C. Holmes, British Columbia; Philip H. Robinson, Nova Scotia; Art Ling, Ontario
- England: R. T. Coales, Hants; F. R. Crowder, Yorkshire; George Ellis, North Stockport
- Irish Free State: Ron. C. Bradley
- Newfoundland: A. L. Hynes, Clarendville
- New Zealand: L. W. Mathie, Hawke's Bay; R. H. Shepherd, Christchurch; Eric W. Watson, Christchurch
- Philippine Islands: George Illenberger
- South Africa: A. C. Lyell, Johannesburg
- Sweden: John S. Bohm, Malung
- Switzerland: Dr. Max Hausdorff, Vi-ganello

appointment of becoming intrigued in a mystery story only to find that the last pages disclosing the solution have been torn out of the book.

RADIO NEWS Special from IOAK

From all reports reaching this department, it would appear that the special program put on by IOAK on April 14th and dedicated to RADIO NEWS was most successful. Joe Dorland, the Master of Ceremonies writes that the number of reports received was unusually high—especially in view of the fact that it was the last DX program to be put on by this station this season. At the RADIO NEWS Broadcast Band Listening Post here in New York City nothing could be heard. This may have been due to the high static level or to the fact that the station was not operating on the announced frequency. Reports from readers who heard the broadcast do not seem to agree as to the frequency actually used and vary all the way from 1140 kc. to 1190 kc. In connection with this broadcast, the DX

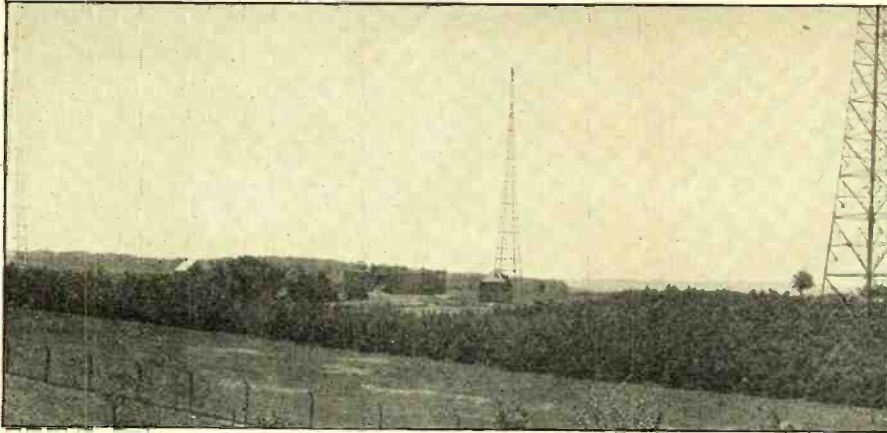

Corner offered two free subscriptions to RADIO NEWS, one to the listener submitting the most complete report and one to the most distant listener. It is a pleasure to announce herewith that the former prize goes to John Clarke, 387 14th Street, Buffalo, N. Y. He submits a 3-page typewritten report in which he quotes every announcement in detail and mentions every musical selection by name.

The prizes for the most distant listener goes to John W. Ker of Sardis, B. C., who submitted a detailed report covering the program from 2:00 to 2:30 a.m. PST.

The Editor wishes to express his appreciation to this station, to Joe Dorland and to Observer Stan Elcheshen, who arranged the broadcast.

Periodic DX Broadcasts

The following list shows periodic DX broadcasts (E.S.T.) which have been brought to the attention of this department by observers or by the DX clubs or broadcast stations participating.

- Tuesdays, 12-12:30 a.m., CFQC, Saskatoon, Sask., 840 kc., 1 kw. (DX tips)
- Thursdays, 12-12:30 a.m., CFQC, Saskatoon, Sask., 840 kc., 1 kw. (DX tips)
- Fridays, 7:45-8 p.m., WORK, York, Pa., 1320 kc., 1 kw.
- Fridays, 11:30 p.m., KLZ, Denver, Colo., 560 kc., 1 kw. (DX tips)
- Saturdays, 12-12:30 a.m., KDKA, Pittsburgh, Pa., 980 kc., 50 kw.
- Saturdays, 12-12:30 a.m., CFQC, Saskatoon, Sask., 840 kc., 1 kw. (DX tips)
- Saturdays, 12:50-1 a.m., WLAC, Nashville, Tenn., 1470 kc., 5 kw. (DX tips)
- Saturdays, 12:15-12:30 a.m., CKCK, Regina, Sask., 1010 kc., .5 kw. (DX tips)

- Saturdays, at sign-off, WCCO, Minneapolis, Minn., 810 kc., 50 kw. (DX tips—CDXR)
- Saturdays, 2:30 a.m., KFI, Los Angeles, Calif., 640 kc., 50 kw. (DX tips)
- Sundays, 12-12:30 a.m., KQV, Pittsburgh, Pa., 1380 kc., .5 kw. (DX tips)
- Sundays, 2-4 a.m., CMQ, Havana, Cuba, 840 kc., 5 kw.
- Sundays, 1-3 a.m., XEWZ, Mexico City, 1150 kc., 1 kw.
- Sundays, 12:45 a.m., WTCN, Minneapolis, Minn., 1250 kc., 1 kw. (DX tips)
- Sundays, May 5th, May 12th, 4-5 a.m., KXL, Portland, Ore., 1420 kc., 1 kw. (CDXR)
- Monthly (the 28th) 4-5 a.m., WKAQ, San Juan, P.R., 1240 kc., 1 kw.
- Monthly (second Sunday), 2-4 a.m., WNEL, San Juan, P.R., 1290 kc., .5 kw.
- Monthly (fourth Sunday), 5-7 a.m., WNEL, San Juan, P.R., 1280 kc., .5 kw.

F.C.C. Monitor Schedules

The complete schedule of monitor transmissions was given in this department in the March issue. Following are the changes which bring that schedule up to date as of April 22, as supplied from Washington.

Add

- Monday: 2:40 a.m., 1310 kc., WMFF, Plattsburgh, N. Y.; 3:40 a.m., 1420 kc., WLEU, Erie, Pa.; 4:00 a.m., 1310 kc., WHAT, Phila., Pa.; 7:40 a.m., KRLC, Lewiston, Idaho.
- Wednesday: 5:40 a.m., 1370 kc., KPRO, Longview, Texas.
- Thursday: 3:30 a.m., 550 kc., WKRC, Cincinnati, Ohio; 4:20 a.m., 1420 kc., KABR, Aberdeen, S. Dak.; 4:40 a.m., 1310 kc., KIUF,

U. S. Station Changes

Kc.	Call	Locations and Changes
550	KTSA	San Antonio, Tex. Granted change in freq. from 1290 kc. to 550 kc. and power to 1 kw. night, 5 kw. day.
560	WNOX	Knoxville, Tenn. Granted extension of authorization to operate on frequency of 560 kc. to October 1, pending commencement of program tests of Station WIS.
580	KMJ	Fresno, Cal. Granted increase in daytime power from 500 w. to 1 kw.
580	WILL	Urbana, Ill. Granted authority to change freq. from 890 to 580 kc.; change power to 1 kw.; daytime hours. Granted authority to operate on 890 kc. with power of 250 w. daytime, 1 kw. night, sharing time with KUSD and KFNF to Sept. 1. Suspended grant to change freq. from 890 to 580 kc., daytime, 1 kw.
580	WIBW	Topeka, Kans. Granted license, 1 kw. night, 5 kw. day, sharing with KSAC.
610	WDAF	Kansas City, Mo. Granted license to cover CP authorizing changes in eqpt. 610 kc., 1 kw. night, 5 kw. day; unlt. time.
620	KGW	N. Portland, Ore. Granted increase in day power to 5 kw.; 1 kw. night, unlt. time.
700	WLW	Mason, Ohio. Granted authority to use 500 kw. from LS to 6 a.m., using directional antenna.
780	WMC	Memphis, Tenn. Granted authority to operate with 1 kw. night, 2.5 kw. day to Sept. 1.
780	KGHL	Billings, Montana. Granted authorization to continue operation on 780 kc. to June 30.
880	WPHR	Petersburg, Va. Granted license, 880 kc., 500 w. daytime.
890	WMMN	Fairmont, W. Va. Granted CP to increase power to 1 kw. day, 500 w. night.
890	WJAR	Providence, R. I. Granted use of 250 w. additional nighttime power to Sept. 1.
900	Frederick, Md. Granted CP for a new station to operate on 900 kc., 500 w. day. Daytime hours.
1010	WIS	Columbia, S. C. Granted authority to increase daytime power from 2.5 to 5 kw.
1180	WMAZ	Macon, Ga. Granted license covering CP, move of transmitter, incr. power from 500 w. to 1 kw. ltd. time.
1200	WMPC	Lapeer, Mich. Granted CP to increase day power to 250 w.
1200	KOOS	Marshfield, Ore. Granted license, freq. 1200 kc., 250 w. day.
1200	KGVO	Missoula, Mont. Granted CP to move transmitter, and to operate unlimited time with 100 w. power.
1200	KFJB	Marshalltown, Ia. Granted change in hours of operation to unlt., 100 w. night, 250 w. day.
1210	WGCM	Mississippi City, Miss. Granted change in hours of operation from specified to unlt.
1220	WDAE	Tampa, Fla. Granted authority to operate with 1 kw. night, 2.5 kw. day, unlt. time, to Oct. 1.
1220	KWSC	Pullman, Wash. Granted CP to increase day power from 2 kw. to 5 kw.
1240	KTFI	Twin Falls, Idaho. Granted use of 500 w. additional night power to Oct. 1.
1280	WIBA	Madison, Wis. Granted authority to operate with additional power of 500 w. nighttime to July 1. Granted increase in power from 500 w. night, 1 kw. day, to 1 kw. night and day.
1290	KTRH	Houston, Tex. Granted CP to change freq. from 1330 to 1290 kc. and

Kc.	Call	Locations and Changes
1290	WEBC	Superior, Wis. CP to increase day power from 2.5 kw. to 5 kw.
1310	KIUF	Santa Fe, New Mex. Granted license to cover CP authorizing new station 100 w. unlt. time.
1310	WCLS	Joliet, Ill. Granted application for unlimited daytime operation.
1310	WBOW	Terre Haute, Ind. Granted CP to change power to 100 w. night, 250 w. day, unlt. time. Suspended grant to increase power from 100 w. day and night to 100 w. night, 250 w. day.
1310	KIT	Yakima, Wash. Granted license to cover increase in day power from 100 to 250 w., 100 w. night, unlt. time.
1310	KFPM	Greenville, Tex. Surrendered license to operate on 1310 kc., 15 w.
1310	KFPL	Dublin, Tex. Granted CP to increase day power from 100 to 250 w.
1310	Lafayette, La. Granted CP for new station to operate on 1310 kc., 100 w. unlt. time.
1320	KGMB	Honolulu, T. H. Granted CP to move transmitter locally and increase power from 250 w. to 1 kw.
1350	KWK	St. Louis, Mo. Granted license to cover increase in day power to 5 kw., 1 kw. night, unlt. time.
1350	WAWZ	Zarepath, N. J. Granted license to increase power from 250 w. night, 500 w. day to 500 w. night, 1 kw. day.
1360	WGES	Chicago, Ill. Granted authorization to operate with 1 kw. from local sunrise to local sunset on Sundays.
1370	WOC	Davenport, Ia. Granted CP to increase day power from 100 to 250 w.
1370	KSLM	Salem, Ore. Application granted to change hours of operation from daytime to unlt. Power 100 w.
1420	WELL	Battle Creek, Mich. Granted CP to move transmitter locally and increase power from 50 to 100 w.
1420	WTAX	Springfield, Ill. Granted change in hours of operation from sharing with WCBS to unlt.
1420	KGIW	Alamosa, Colo. Granted change in hours of operation to 7 a.m. to 4:30 p.m. daily and 6 to 9:30 p.m.
1420	KIDW	Lamar, Colo. Granted change in hours of operation to 7 a.m. to 6 p.m. daily; 9:30 p.m. to 12 midnight.
1420	WJBO	Baton Rouge, La. Granted change in hrs. of operation from 100 w. day to 100 w. night and day, unlt. time.
1420	KRLC	Lewiston, Idaho. Granted license freq. 1420 kc., 100 w., unlt. time.
1420	WPRP	Ponce, Puerto Rico. Granted authority to operate 20-watt portable transmitter on 1420 kc. in the vicinity of Ponce, P. R., between 1 and 6 a.m. AST, for a period ending Aug. 18.
1420	WCBS	Springfield, Ill. Suspended grant to change freq. from 1210 kc. to 1420 kc.
1460	KSTP	St. Paul, Minn. Granted permanent authorization to operate with 25 kw. from 6 a.m. to 12 p.m.
1470	KGA	Spokane, Wash. Cancelled special authorization to operate on 900 kc. and ordered back to 1470 kc. to operate with 5 kw.
1500	KPQ	Wenatchee, Wash. Granted license freq. 1500 kc., 100 w. night, 250 w. day, unlt. time.
1500	WKEU	Griffin, Ga. Granted license to cover move from LaGrange to Griffin Ga., and change hours to daytime only, 100 w.
1500	WPGA	Rome, Ga. Granted change in hours of operation from specified to unlt., 1500 kc., 100 w.

Santa Fe, N. Mex.; 4:50 a.m., 1370 kc., KFGQ, Boone, Iowa; 5:10 a.m., 1370 kc., WPAV, Portsmouth, Ohio.
Friday: 5:00 a.m., 1430 kc., KSO, Des Moines, Iowa.

Delete

- Monday: 2:50 a.m., 1310 kc., WHAT, Phila., Pa.; 4:30 a.m., 1200 kc., WNBO, Silverhaven, Pa.
- Thursday: 5:10 a.m., 1370 kc., WHBD, Mt. Orab, Ohio.
- Friday: 5:00 a.m., 1430 kc., KWCR, Cedar Rapids, Iowa.

Changes

- Monday: 2:50 a.m., 1420 kc., WHDL, Olean, N. Y., changed location from Tupper Lake, N. Y.; 4:20, 1260 kc., KGVO, Missoula, Mont., frequently changed from 1200 kc.
- Tuesday: 2:00 a.m., 1210 kc., WPAX, Thomasville, Ga., call changed from WQDX; 3:00 a.m., 1370 kc., WMBR, Jacksonville, Fla., location changed from Tampa, Fla.
- Wednesday: 2:50 a.m., 880 kc., WPHR, Petersburg, Va., frequency changed from 1200 kc.; 3:10 a.m., 1420 kc., KGIW, Alamosa, Colo., location changed from Trinidad, Colo.; 5:30 a.m., 900 kc., WTAD, Quincy, Ill., frequency changed from 1440 kc.
- Thursday: 4:30 a.m., 1500 kc., WKBZ, Muskegon, Mich., location changed from Ludington, Mich.; 4:40 a.m., 1420 kc., WCBS, Springfield, Ill., frequency changed from 1210 kc.
- Friday: 3:30 a.m., 1200 kc., KGEK, Sterling, Colo.; location changed from Yuma, Colo.
- Saturday: 3:00 a.m., 1200 kc., WJBC, Bloomington, Ill., location changed from LaSalle,

CDXR Convention

Observer Kalmbach calls attention to the fact that the First Annual Convention and Banquet of the Canadian DX Relay is to be held at St. Catharines, Ontario, on Saturday, August 31, 1935. On behalf of this organization he extends an invitation to all DX'ers to attend. There will be a sightseeing trip during the afternoon, speeches from club officials, a display of cups and prizes, etc.

A descriptive folder telling all about the convention may be obtained by writing to Albert Sandham, 99 Page Street, St. Catharines, Ontario.

Verifications

Observer Rank writes as follows—and what he has to say is well worth the serious attention of DX'ers:

"Please advise DX'ers not to send money to foreign stations. Tell them to get an International Reply Coupon or else get the country's stamps from the International DX'ers Alliance's stamp exchange. I hear the cry from some DXing friends, 'I sent data to Australia—so and so station, and never got a veri. I sent

them a dime also.' All the foreign stations can do with American coins is to make souvenirs of them, and Lord only knows they probably have a bushel of American dimes and nickels."

Paraguay Stations

Following is the official list just received from V. Berton, Chief of the International Postal and Telegraph Service of Paraguay:

Kc.	Watts	Call	Location
700	10	ZP15	Villarrica
736	45	ZP4	Asuncion
810	100	ZP1	Asuncion
885	1500	ZP9	Asuncion
1050	100	ZP7	Asuncion
1250	10	ZP6	Asuncion
1376	15	ZP5	Asuncion
1429	10	ZP13	Asuncion

DX'ers Lament

The following notes taken from a letter from Observer Tomlinson describe an experience that we have probably all suffered at one time or another but which is always humorous—when the joke is on someone else. His remarks are quoted as follows: "The T.P.'s have proven a flop to most of us in this district. They started out with a bang but between high static and local noise one cannot get a decent report on them. However, on April 15th at 3:00 a.m. several of the T.P.'s were above the static and at 3:30, 1YA, 2YA, 3YA, 4YA, 2CO, 2BL, 2UE, XGOA and JOHK could be copied nearly solid, so picked out the best at 3:35 which was 3YA and got busy, intending to take them in turn each 25 minutes. I copied 3YA until 3:52, which is my last notation in log. The next thing I knew it was 7:30 a.m. and the wife was shaking me. I had fallen asleep in the chair with the set on, thereby missing the best T.P. morning yet and the only time I had a Jap or Chinese station which I could really copy. This is what I call a break. I got the 3YA report off, though."

Our Readers Report—

Observer Covert (California) offers some problems in which perhaps other DX listeners can help him. He writes: "For two nights now, I have heard a Spanish speaker with band music at 10:30-11:00 P.M. on 706 kc. I think he is the same one who was coming in smack on top of WLW several weeks ago. Who could he be? His heterodyne with KMPC is something terrible. I also heard a queer intermittent signal on 695 or thereabouts, which I cannot identify. I believe that CJCJ was heard last night on 690 kc., but it seems incredible. I heard something which sounded like "This is KFBR" or KSCJ, which led me to believe that maybe I had landed CJCI. I am still wondering whether the very loud Cuban (Havana) on 1105 was CMCY or not."

Observer Nichols (Connecticut) reports that heavy static in his locality has made DXing all but impossible. He sends in a bit of interesting information concerning CTIGL and CTIGO, as follows: "Captain Jorge Bothello Moniz, President of the Radio Club Portuguese, CTIGL and CTIGO, writes me that his club has 6400 members in it, being some 20% of the listeners in Portugal. They are very pleased with results of their DX broadcasts this past season and will be glad to put on more next season for DX'ers over here."

Observer Diedrich (Illinois) sends in a list of 40 trans-pacific stations tuned in by him during March and April. He also reports: "Listening conditions on week-ends, when most people do their DXing, have been terrible for the last two weeks, either raining or snowing, causing a lot of static. The TP signals have not increased with the coming of Spring in proportion to what they were in the Winter months."

Observer Rebsdorf (Illinois) reports that he has logged 602 stations to date, of which 401 are verified. His recent reception, like that of so many other Official Observers has been practically ruined by the high static level. In spite of this, he has been able to hear 1YA several times, and also reports KGMB heard during April.

Observer Smith (Illinois) reports that his log shows reception of 13 T.P.'s this Spring. He advises all DX'ers to keep their ears open for several new American stations which are now on the air or shortly will be put into operation.

Observer Byers (Iowa) lists the following stations which he has tried for frequently but has never succeeded in hearing. He feels that these are good stations for DX'ers in his locality to shoot for: KGLX, Las Vegas, Nev., 1420 kc.; KGNO, Dodge City, Kans., 1340 kc.; WKAR, East Lansing, Mich., 1040 kc.; WIOD, Miami, Fla., 1300 kc.; KGW, San Jose, Calif., 1010 kc.

Observer Hammond (Maine) reports some luck with the T.P.'s and S.A.'s during March and April in spite of almost continuous bad static conditions. He also reports: "Got my prize veri from 7UV, Ulverston, Tasmania, 300 Watts, 1450 kc. They enclosed a verification card and two-page letter giving information on their station, and time table."

Observer McVey (Maryland) who is also a Super Ace of the Newark News Radio Club, is the proud possessor of over 600 verifications in

spite of the fact that he has never made any conscious effort to see how high he could run the total. He has heard every continent on the broadcast-band. One of his proudest accomplishments this season was to tune in CTIGL from 1:16 to 2:20 a.m. while WTIC was still on the air (up to 2:00 a.m.). He wonders how many other DX'ers, especially in the Eastern part of the United States, were able to hear this Portuguese station through the interference of WTIC.

Observer Bauer (Maryland) reports 610 stations heard with 450 verifications and 20 reports out to Mexican stations and a number to European stations. Judging from the number of verifications held by Observers Bauer and McVey, it would seem that Maryland is more or less a garden spot for DX'ers.

Observer Geller (New York) reports that he has logged 400 stations and has had 360 verified. These include European and S.A. stations. He has also heard a number of T.P.'s but not well enough to verify.

Observer Southward (Ohio) reports that static and local QRM were so high during the Spring that he was unable to accomplish any worth while T.P. reception except on two days. On these two days he picked up 5 Australians and 2 N.Z.'s. He also reports hearing 10AK, the little 15 Watt Ontario station, during their broadcast of March 31st. At the time they were operating on 1180 kc. instead of 1200 kc.

Observer Hunter (Oregon) offers the following list which he believes will be useful to other DX'ers in his locality as it includes the stations which he hears regularly weekday mornings.

Kc.	Call	Hours P.S.T.
560	KTAB	12:00—1:00 a.m.
600	KFSD	12:00—12:05 a.m.
640	KFI	12:00—12:05 a.m.
710	KMPC	12:00—1:00 a.m.
710	KPCB	12:00—3:30 a.m.
760	KXA	12:00—1:00 a.m.
780	KTM	All night
900	KHJ	12:00—1:00 a.m.
930	KROW	12:00—2:00 a.m.
1040	KWJJ	12:00—3:15 a.m.
1070	KBS	All night
1100	KGDM	All night
1200	KGJF	All night
1300	KFAC	All night
1330	KGB	12:00—1:00 a.m.
1420	KBPS	12:00—12:30 a.m.

Observer Kocsan (Pennsylvania). "10AK was also heard and verified this past month. It sure puts in a nice signal down here. KGU comes on the air at 6:30 (Honolulu time) a.m. with a 15-minute period of Sunrise Melodies, and signs off at 10:30 p.m. with a program from the Hawaii Speedway—a half hour of Midget Auto Racing. For the fifth consecutive month the following stations failed to come through on their frequency checks: WDAH; KFXJ; KGGM; KGIK; KGU; KMLB; KGEZ; KGBU; KPO; ICGY; and KRKO. I've received all the others assigned to monthly frequency checks."

Observer Drain (West Virginia). "I hear 1YA, 2BL and 4RK occasionally about 5:00 a.m., EST. On two occasions I had a trace of 3LO, Melbourne, Australia, but they were not of verifiable strength. Trans-pacific reception on the broadcast band has been a bust around here. In addition I heard LR4 on 990 kc., and I held them for an hour. I had them at 2:00 a.m. I tuned in HHK also, near 4:00 a.m., and 10AK at 5:00 a.m."

Observer Jurd (Australia) reports reception of ten U.S.A. stations, one Russian and four Indian stations and practically all of the Chinese and Japanese stations. He further reports that from 2:15 to 6:00 a.m. on March 3rd he logged 47 European stations at one sitting. His report goes on: "In your issue of January, 1935, Official L.P.O. Ansell, Regina, Saskatchewan, writes: 'Another station which I have been unable to identify after 3 weeks endeavor is coming in on 980 kc., which I believe to be that new Aussie—4AY, Aylbury.' I may correct him here. This is 4AY, Ayr, near Townsville, N.Q., and only 50 miles from my own home."

Observer Shepherd (New Zealand) states that 4BC, Brisbane, has changed from 1145 kc. to 1035 kc. This is perhaps a temporary change as the new frequency assignments which go into effect on September 1st show that 4BC will operate on 1120 kc. after that date. He further reports: "A new station, 2TM, Tamworth, New South Wales, is now operating on 1490 kc. power unknown, but probably 100 watts. Another Australian station, government-owned, will probably be testing shortly on 630 kc. call unknown, but power will be 5 or 10 kw."

Observer Watson (New Zealand) lists the following Americans heard best in New Zealand: KTAB, KMTR, KHO, XEPN, KFSD, KFRC, KFI, KPO, WLW, WSB, WBBM, KGO, WCCO, KGA, KHJ, KNX, KMOX, KFSG, KSL, KVOO, KFOX, KFAC, KGB, XENT, KSTP.

Observer Lyell (South Africa) reports that reception conditions in his locality continue to be most disappointing. Improved conditions usually anticipated in February did not materialize although the veil was lifted for a short time about 4:00 a.m. one morning which enabled him to tune in 17 European stations, 7 S.A.'s and 3 U.S. stations,—the latter being KSL, WTAM and WTIC.



BRINGS YOU
The Delightful New
HIGH FIDELITY PROGRAMS

A NEW RADIO THRILL
Yours through
TRIPLE REPRODUCTION and SUPER-POWER!

This latest advancement of radio science brings in the real high fidelity programs. Ordinary radio receivers reproduce up to 4,000 cycles... regular high fidelity receivers up to 7,500 cycles... Only the SCOTT covers full tonal range of the new high fidelity broadcast stations from 25 to 16,000 cycles, permitting real enjoyment of every note and delicate overtone.

Brand new scientific developments... typical SCOTT accomplishments that again lead the radio field by years... supply a marvelous triple reproduction system that, for the first time in radio history, permits you to hear everything in music and speech via the radio. The higher harmonics and overtones that give character and musical instruments their real character are never heard in ordinary radio reproduction. The new SCOTT makes music and speech actually live and sparkle with the reality your ear recognizes when heard in person. This takes tremendous super-power amplification... better than six times that of average receivers. The SCOTT has full 35 watts absolutely undistorted class "A" output and up to 50 watts class "A" prime... which is vitally necessary to care for "peaks" when full orchestration crashes in a fortissimo passage or a singer's voice soars high.

UNEQUALLED DISTANCE
There are no distance boundaries for SCOTT owners! This phenomenal new receiver gives world wide reception on every channel between 13 and 550 meters, and picks up stations in the most remote spots of the globe, bringing them in with clarity and delightful tone that will amaze the most critical listener. Extraneous noises—the bugbear of foreign short wave reception—in the new SCOTT are very greatly reduced. Only the new SCOTT provides... in one receiver... a combination of full range high fidelity and razor-sharp selectivity constantly variable to meet every reception condition. Custom-built, to most exacting laboratory standards, the new SCOTT is sold (in the U.S.A.) from the laboratory on a 30-day home trial basis.

WE PROVE IT TO BE THE WORLD'S BEST RADIO!

PROVE every claim by our Comparative Check List that makes it easy to learn the truth about the performance of any radio.

E. H. SCOTT RADIO LABORATORIES, Inc.
4440 Ravenswood Ave., Dept. 5M5, Chicago, Ill.

Send at once full details about the new SCOTT receiver, PROOF of its marvelous performance, and your COMPARATIVE CHECK LIST.

Name _____
Address _____
City _____ State _____



"FIBBER MCGEE AND MOLLY"

LEFT:
GOGO DE LYS



BENAY
VENUTA



LEFT.
ETHEL MERMAN

BACKSTAGE IN BROADCASTING

LENNIE HAYTON, the young maestro who soared to the radio fore in recent seasons, is conductor of the 45-piece dance orchestra presented on "The Hit Parade," sponsored by Lucky Strike cigarettes on NBC Saturday nights. The aim of the program is to present the fifteen "leading" song hits of the week on each program. To decide on just which are "leading" the sponsor will have agents in New York, Chicago and Los Angeles check on the public's preferences. Sheet music and phonograph record sales, requests received by prominent radio, night club and hotel orchestras, and the number of times a selection is played on the air will be tallied to determine the nation's song hits. Gogo DeLys, Kay Thompson and Johnny Hauser, were assigned the vocal solo spots on this important week-end feature.

RADIO'S noted headline hunter—Floyd Gibbons—absent from the air for a spell, is once again back on NBC's wavelengths reporting the progress of recovery for the radio audience for the third time. Floyd covers the battlefield of the depression for his old sponsor, the Johns-Manville Corporation on Thursday nights. Floyd's swift-fire descriptions are based on the national administration's "attack on

FLOYD GIBBONS



Samuel Kaufman

the forces of the depression," according to a network announcement.

RADIO'S newest comedy team is that of "Fibber McGee and Molly" who, in real life are Marian and Jim Jordan. The pair are featured on the new Johnson's Wax program of NBC, Tuesday nights. Marian and Jim have been in radio ten years, but this is their first real break on a sponsored chain feature. Fibber and Molly are supported on the new series by Ulderico Marcelli's Orchestra, and Ronnie and Van, comedy vocal duo.

BENAY VENUTA, CBS's new songster, is a native of San Francisco who started her stage career at the age of four. At the age of thirteen—that was ten years ago—she sang in a Fanchon and Marco production. After some European schooling, she appeared in vaudeville and picture houses. She made her microphone debut in San Francisco in 1930. The same year she wrote continuities and did production work on KFRC. Now at WABC, key of the CBS, she seems destined for a stellar radio career.

ETHEL MERMAN, prominent stage, screen and radio vocalist, has been awarded the distinction of occupying the CBS Sunday program spot vacated by Eddie Cantor. Under the sponsorship of

Lehn & Fink, Miss Merman is heard weekly with Al Goodman's Orchestra and Ted Husing, the announcer. Ethel's vocal bits are the highlights of each show but she also engages in amusing verbal tilts with Husing. Short dramatic sketches by Everett Freeman are also worked into this variety half-hour. Al Goodman, now one of the busiest baton-wielders on the air, was recently assigned the conductor's post of NBC's Thursday Palmolive Beauty Box Theatre. Incidentally, the latter show is now well into its second year and deserves a round of listener applause for consistent good program fare.

SOME queries have recently reached us regarding the chain of four stations known as the Mutual Broadcasting System. The hook-up, which is co-operative, includes WGN, Chicago; WLW, Cincinnati; WXYZ, Detroit, and WOR, Newark. Commercial as well as sustaining features are routed over the permanent wire-lines linking the four well-known stations. Such prominent network names as Singin' Sam and Arthur Tracy ("The Street Singer") are included in the Mutual schedule. A representative of the combine tells us that the four transmitters adequately serve the major population centers east of the Rockies. As an economy measure, he said, there is no special Mutual staff, the individual station personnel handling all of the chain's details. W. E. MacFarland, of WGN, is president of the four-station

LENNIE HAYTON

AL GOODMAN

ALFRED J. McCOSKER





KAY THOMPSON

chain, while Alfred J. McCosker, of WOR, is chairman of the board of directors.

MRS. GERTRUDE BERG, creator of the erstwhile NBC script act known as "The Goldbergs" has returned to the network's roster as author and star of "The House of Glass," presented Wednesdays under the sponsorship of the Colgate-Palmolive-Peet Company. The program deals with daily events in the lives of the Glass family and the guests at their Catskill Mountain hotel in the imaginary town of Glassburgh, New York. Mrs. Berg, who had the role of Molly Goldberg in her previous series which had a five-year run, is the mother of two children and divides her time between her home and the studios. The new series' cast also includes Joe Greenwald, Paul Stewart, Bertha Walden, Helene Dumas, Arline Blackburn and Celia Babcock.

ANNE CAMPBELL, the "poet of the home" featured on CBS, was born on a Michigan farm, attended a rural school, and began writing poetry almost as soon as she could hold a pencil. She finished her education in Detroit and joined the staff of a farm magazine where many of her rural poems were published. After marriage, she forsook her professional career for that of homemaking. Her occasional writings, though, attracted the attention of a Detroit editor who requested a poem a day for his paper.

GERTRUDE BERG

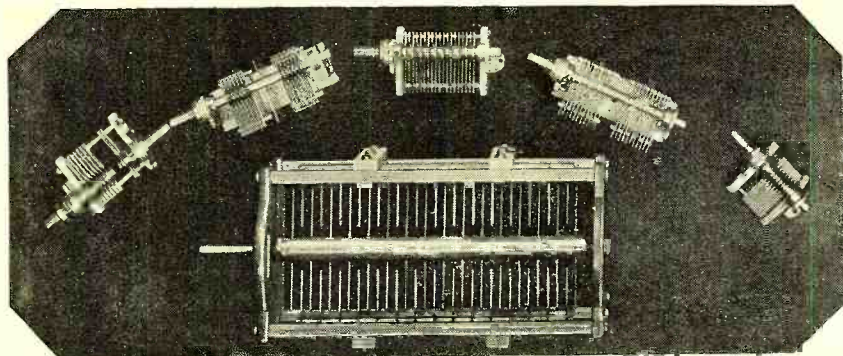

HAMMARLUND CONDENSERS

Made in
18 TYPES
For Every Radio
Purpose

WHATEVER your condenser need may be—for transmitting, receiving, trimming, balancing, padding, antenna tuning, etc., Hammarlund makes it in the required capacity rating.

Eighteen different types for every radio purpose—priced at 30 cents to \$18.00 list.

And as to QUALITY—practically every amateur and professional operator, and every radio manufacturer throughout the world, since 1910, has respected Hammarlund prestige.

But talk is not proof. Put Hammarlund Condensers to the severest tests and let experience demonstrate how greatly they improve the performance of any circuit.



Write Dept. RN-7 for Details

HAMMARLUND MFG. CO.
424-438 W. 33rd Street
New York, N. Y.



KILL SHORT-WAVE NOISE

G-E

V-DOUBLET ALL-WAVE ANTENNA

The direct result of years of transmitting-antenna experiments at G-E short-wave stations W2XAD and W2XAF. Reduces man-made noise to the minimum. Can be installed at a distance from the set, remote from interference source. The unique coupling system provides maximum signal pick-up with minimum noise—the nearest approach as yet to short-wave antenna perfection. Automatically adjusts itself to broadcast reception.

Price completely assembled, \$5.95.

For complete technical data, write today to Section R-167, Merchandise Department, General Electric Company, Bridgeport, Conn.

GENERAL ELECTRIC

RADIO

MERCHANDISE DEPARTMENT
GENERAL ELECTRIC CO., BRIDGEPORT, CONN.

Public Address

.. get set for the Summer rush...

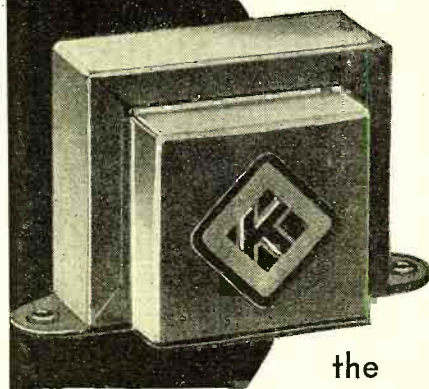

the "SILVER GROUP"

and a complete line of Public Address Kits are now available.

Bulletin C-1 describes the new Silver Group Units in detail and shows many practical amplifier applications. If your local Radio Parts dealer cannot supply you, write direct to:

KENYON TRANSFORMER CO., INC.
800 Barry St. New York, N. Y.

New



**ELECTRAD
VOLUME CONTROL**

**Guaranteed
QUIET**

BUILT on a radically new engineering principle, and *individually tested for noise*, the Electrad is the smoothest, quietest, longest-lived volume control ever devised.

Get the *facts* and you'll prefer the Electrad Volume Control to any other.

175 Varick St., New York, N. Y.
ELECTRAD
MAIL COUPON FOR
1935 CATALOG

ELECTRAD, Inc.
175 Varick St.,
New York, N. Y.

Please send new Resistor Catalog... Check here for folder on new QUIET Volume Control.

Name.....
Address.....
RN-7

**AMERTRAN
TRANSFORMERS**
For Public Address



**BETTER QUALITY AT
A MODERATE PRICE**

AmerTran SilCor Components are designed to meet requirements in public-address amplifiers. All audio types are liberally designed to offer frequency characteristics uniform within ± 2 db from 60 to 8000 cycles; filter types give full inductance with rated d.c. flowing; and power transformers have better than 10% regulation. They are, indeed, thoroughly dependable amplifier parts offered at a moderate price within the reach of all.

Ask for Bulletin No. 1002
**AMERICAN TRANSFORMER
COMPANY**
177 EMMET ST. NEWARK, N. J.

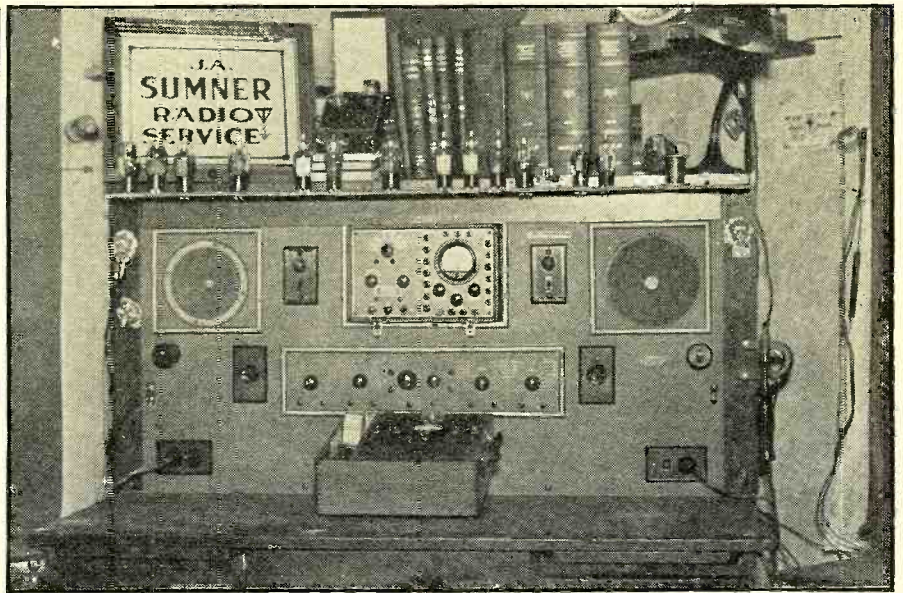

THE SERVICE BENCH

ZEH BOUCK

SAVING MONEY BY RE-WINDING SPEAKER FIELD COILS

WITHIN reasonable limits the less dependent the serviceman is upon the parts supply houses, the better service he can render his customers and often at greater profit to himself.

MR. WILBUR W. WORLEY, of Shreveport, La., who looks cordially at us from Figure 1, has solved the speaker-field problem to his own satisfaction and to that of his clients. Concerning the winding device shown in Figure 2, he writes: "The idea occurred to me during a rush business in repairing open fields. I got in touch with a machinist and *traded him radio service work* for the gadget illustrated. Since I have had the machine in my shop, I have not had to buy a single coil. I have accumulated quite a few coil forms, and make up special ones as the necessity arises. The electric drill is a $\frac{1}{4}$ -inch size of popular make. It can be readily demounted from the winding frame and used for its more conventional purpose. The drive shaft, of course, fits the chuck, and carries a 1-inch gear. The driven gear is $3\frac{3}{8}$ inches in diameter. The coil and form on the machine, as photographed, are for the R32 Victor speaker. The drill is operated in series with a 150-watt lamp, or equivalent, which provides a comfortable winding speed."

FIGURE 2

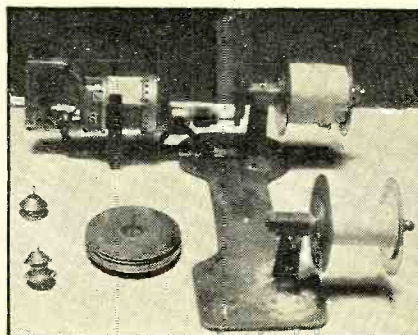

THIS MONTH'S SERVICE SHOP

Roll top desks have gone the way of the horse and buggy, and such relics can often be picked up at second-hand furniture stores and auctions for a song. They are readily convertible into excellent service benches, as will be observed from the photograph in our heading this month, which bears tribute to the ingenuity of J. A. Sumner, New Bedford, Mass. The roll top, front sides and pigeon-holes were removed—a matter of elementary carpentry. Symmetrically arranged on the "prestwood" panel are the following: Upper right-hand corner, a.c. dynamic speaker; upper left, d.c. dynamic; center top, a Philco 048 tester; center, a resistance and capacity substitution panel. A tube rack borders the top of the panel, behind which can be seen Rider's manuals and a Tobe condenser tester. The portable equipment on the bench is a Supreme type

FIGURE 1





FIGURE 4

85 tube tester. Adequate lighting, plenty of outlets and the very convenient drawers that are so generously a part of the old-time desks, complete the efficient picture.

Radio Accounting for Servicemen

An excellent 27-page booklet on "Radio Accounting and Records" has just been issued by the National Radio Institute,

Washington, D. C., as a part of their regular course. It is being distributed in individual copies, however, by National Union, and can also be secured from the N. R. I. directly for thirty cents. This book tells the serviceman, or the proprietor of any one-man business, all that he needs to know on the subject of book-keeping.

THIS MONTH'S SERVICE-SALES TIP

The photo of Figure 3 shows a display board conceived and executed by the management of Hertel's Radio Store, Clay Center, Nebraska, in the successful effort to build up a side-line trade in electrical parts. This exhibit is particularly helpful to amateur electricians, who rarely know the exact names of the parts required and whose description of the same are seldom accurate enough to provide identification. (Turn to page 61)

V-Antenna

(Continued from page 25)

with a straight feeder, and the signal strengths of the signals were only reduced a moderate amount over a straight antenna without a noise-reducing lead-in. The V doublet operates on the broadcast band as a straight T-type antenna. Signals on 16 and 19 meters were easily pulled in from Europe. The 25-meter range was excellent. Australian signals were received with exceptional clarity from all three stations on 31 meters. The 49-meter band was also found free from inductive interference and especially was this useful in connection with the reception of the South American stations.

In the third location where the antenna was tested a transmission line ran along in front of the house and a pole nearby contained what we believe to be a leaky circuit causing extremely loud noise (with an ordinary antenna) which not only interfered with the very short-wave stations but also extended up to the police band. When properly lined up to "point" at this source, which was unsuspected before the installation was tested, the noise disappeared and short-wave reception was thereafter possible. We find the claims of the manufacturer well supported and this antenna is very easy to put up and install complete. We feel that it makes an ideal installation for any home installation for short-wave reception. One recommendation that should not be forgotten is to install the antenna as far in the open as possible, even if a 100- or 200-foot feeder pair is used.

A
Statement
about
METAL TUBES
by
R. L. Triplett



R. L. Triplett, President, Triplett Electrical Instrument Co.

"FROM the many letters and telegrams that have come to my desk within the past few weeks, I have noticed that the most widely discussed topic in the radio industry today, is that of the new Octal metal tubes and what effect they may have on testing equipment.

"I want to take this opportunity to assure all servicemen that the Triplett Electrical Instrument Company has been at work on the development of their test equipment for some time, and that Triplett engineers have responded to the new requirements immediately, covering the advent of the new Octal tubes.

"The Triplett 1210 and 1220-1166 Testers are the only Triplett instruments that require 8-prong sockets and adapters to take care of the new Octal metal tubes. Adapters offer no complications and are already available at your jobbers, enabling you to modernize these instruments quickly if you are using them in your service work. For information, consult your jobber or write directly to me."

Triplett Electrical Instrument Co.
154 Main Street,
Bluffton, Ohio

Mr. R. L. Triplett: Please send me complete information on Triplett Testers for testing the new Octal tubes and circuits.

Name.....
Street.....
City.....State.....

Cash Prizes for Servicemen

EVERY radio service business, no matter how successful in a financial way, can jazz up the "tune of the cash register" through the application of ideas that will pull in extra customers. These extra customers may be gotten through new ideas in receiver servicing, in sound-system installation or rental, in the novel display or presentation of new receivers for the home, automobile or boat. The trick in all this is to get the necessary ideas which can be capitalized!

Every serviceman from time to time works out some idea which proves to be a business getter and brings in extra dollars. It is felt that through an exchange of such ideas servicemen readers of RADIO NEWS can cash in handsomely, and so RADIO NEWS plans to publish tried and proved suggestions along this line. To further this end, five cash prizes will be awarded each month, beginning with the August issue, for the most practical ideas submitted. The prizes are as follows:

FIRST PRIZE, \$10

SECOND PRIZE \$5 FOURTH PRIZE \$5
THIRD PRIZE \$5 FIFTH PRIZE \$5

In addition to the prize-winning ideas, a consolation prize of \$2 will be paid for each idea published. To enter this contest it is necessary only that you be actively engaged in some branch of radio service work. You can submit as many ideas as you want. Describe each one briefly and clearly on a separate sheet of paper and address them to the Service Contest Editor, RADIO NEWS, 461 Eighth Avenue, New York City.

RADIO PHYSICS COURSE

ALFRED A. GHIRARDI

Lesson 42. Self-inductance

As we shall now see, the self-induced e.m.f. set up in any inductor connected in an alternating-current circuit not only "impedes" or opposes the current flow, but also makes the variations in the alternating-current flow lag behind the corresponding variations in the applied e.m.f.

Let the diagram at the left of Figure 1 represent an inductor connected across an alternating source of e.m.f. Let us suppose for simplicity, that the wire of which this inductor is made does not have any resistance whatsoever, so that any opposition offered to the flow of current is due solely to its self-inductive effects.

Let curve (A) at the right of Figure 1 represent the sine-wave voltage applied to the inductor. The current flowing as a

may be constructed as shown through points D-E-F-G-H-I-J-K-L.

Examination of these curves shows that when the applied e.m.f. starts at the instant O and increases in strength from O to P, the current is not yet flowing. In an inductive circuit it takes a definite time, perhaps a small fraction of a second, for the current to reach some steady value. After the applied e.m.f. has gone through one quarter of a cycle from O to P the current is just beginning to flow at D. Now as the applied e.m.f. decreases from P to R, the current starts to increase from D to F. Therefore the changes in the current lag the changes in the applied e.m.f. by one quarter of a cycle, or 90 electrical degrees. This is an important characteristic of an alternating-current circuit in

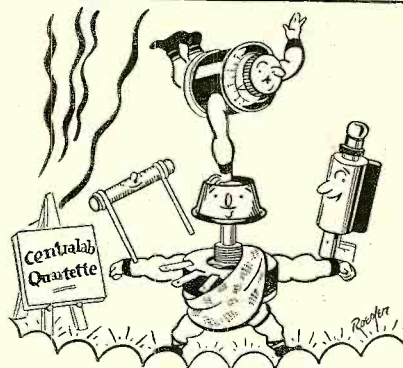

Here's a "Troupe" that Wows 'Em!

FOUR husky boys, these, that have been on most of the world's best circuits.

Fathered by old man Radiohm himself, he and his three sons Kid Suppressor, Kid Resistor and the new member of the team, Big Boy Sound Projection Control, are in the spot light of popularity with servicemen and experimenters everywhere. How these boys can work! It's a pleasure to watch 'em . . . smooth, efficient, noiseless and each performance as reliable as the next.

Note: Mr. Trouble Shooter . . . stock up with Centralab Replacement parts . . . the cheapest in the long run.

CENTRALAB

Division of Globe Union Mfg. Co. Milwaukee, Wis.

Radiohms—Suppressors Resistors

Earn Money with this WONDERFUL NEW INVENTION!

Real Money Maker for Part or Full Time AGENTS!

Make quick PROFITS with new, patented invention—sells on "flash" demonstration. Main or side-line. Big, new market.

Soldering Iron and Blow Torch IN ONE! Light, portable. Eliminates pump, pressure system, stove, charcoal—ALL!

PROOF IT SELLS!—Agent Rowland earned \$300 a month. — Ware sold 60 irons while stopping in hotel! "Going like hot cakes," says Bailey.

WRITE quick—get established for EXCLUSIVE territory. A postal will do!

JUSTRITE MFG. CO., 2061 Southport, Dept. B100 Chicago

TELEVISION

Complete training in all branches of RADIO including Television. Also full Electricity Course without extra cost. Earn room and board while learning. 30,000 graduates. Coach R. R. fare allowed to L. A. Write for Free Book.

NATIONAL SCHOOLS
Dept. 7-RN 4000 S. Figueroa, Los Angeles

AMERICA'S First Complete TRAINING COURSE now ready

"SCOUT" ONE TUBE Shortwave Kit

Can be assembled by anyone. Complete with blueprints. Uses one 230 tube.

Complete Kit with one coil. . . \$1.95
R.C.A. Licensed 30 Tube.40
Set of three extra coils.50
Wired extra.50

TRY-MO RADIO CO. INC.
85 Cortlandt St., 179 Greenwich St. N.Y.C.

WRITE IN FOR DETAILS OF SPECIAL RADIO REFERENCE SERVICE

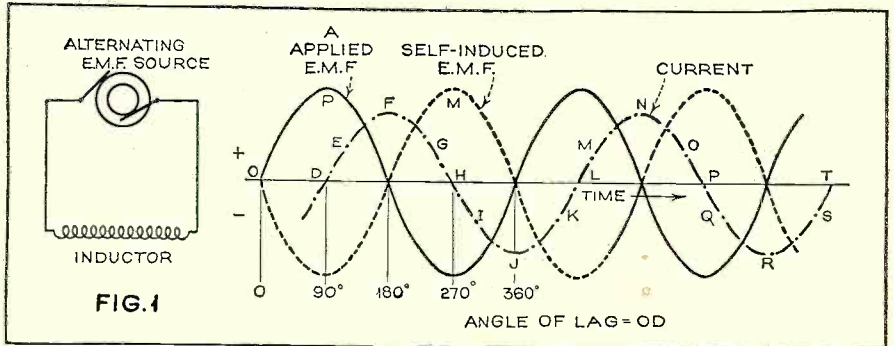

result of the application of this e.m.f. to the circuit produces a varying magnetic field around the inductor which sets up in it a self-induced e.m.f. which is opposite in direction and value to the applied e.m.f. at every instant (Lenz's law). Therefore this e.m.f. also varies exactly as the applied e.m.f. does, but since it is always opposite in direction its curve may be drawn as shown by (B).

Since the value of the self-induced e.m.f. induced in the inductor at any instant is proportional to the rate of change of the current flowing through the inductor at that instant, it will have its maximum value when the current is changing fastest in value (not when the current the current is greatest) and will have its minimum value when the current is changing slowest. When the current flow, and therefore the magnetism, is at the maximum value in either direction, as at points F and J, its strength varies very little within a given momentary period of time, as indicated by the fact that the curve is almost horizontal at these points. Consequently the self-induced e.m.f. is zero at the moment the current and magnetism are at maximum value. When the current flow and therefore the magnetism is going through its zero value as at point H, it is changing in strength rapidly (as shown by the fact that the slope of the curve is steep at this point) so the self-induced e.m.f. is at maximum value. Therefore at the point R, when the self-induced e.m.f. is zero and just about to increase in the positive direction, the current must be maximum (minimum rate of change) at point F, and just ready to decrease down to zero value. Likewise at the point M, when the self-induced e.m.f. is maximum and just about to decrease, the current must be at minimum value (maximum rate of change) at point H, and just ready to increase in the opposite direction. Thus the current wave

which pure inductance is present. As we shall see later, if resistance or capacitance is also present in the circuit, the amount of lag of the current variations depends upon the relative values of the resistance, inductance and capacitance. It may be less than 90 degrees, or the current variations may not even lag at all, but may lead those of the voltage.

The Valentine "Superhet"

(Continued from page 7)

The only major circuit difference between this tuner and the original relate to the use of a 56 connected as a diode second detector, and a 56 as audio amplifier. A 2A7 was tried as a mixer and oscillator, and rejected in favor of the 57 detector and 56 oscillator. The degree of coupling can be controlled better by using two tubes.

An attempt has been made in the preceding paragraphs to give a general description of the V-8 and the reason for its particular characteristics. A more detailed analysis of its construction and circuit will be given in an article to follow. Some hint has been given as to its capabilities and although not built primarily with the idea of attaining extreme DX reception, the attention which has been bestowed on both electrical and mechanical details has given it a degree of sensitivity greater than was hoped for, and capable of meeting the demands of the most rabid DX'er. Full compensation for the labor involved is obtained in the delightful tonal results, free from extraneous noise, (atmospheric, etc. conditions being right) which can be had when it is used in conjunction with a good amplifier and reproducer.

The "Ham" Shack

(Continued from page 29)

their equipment in order that the other fellow might see what "the other fellow is doing." RADIO NEWS will pay \$1.00 to cover printing and mailing costs for each photo published in this department, or \$2.00 for photos including a clear view of RADIO NEWS Magazine in the picture. Clear glossy prints are essential.

Danford Adams, a short-wave listener at Kakadjo, Maine, calls attention to the excellent manner in which a group of 75-meter 'phone stations handled the news of the Macon disaster between Hollywood, Cal., and Lakehurst, N. J. The stations relayed the news with accuracy and speed that was equal if not superior to commercial communication practice. The stations who participated in the emergency relay include W6CNE, W9MM, W7BCU and W6BIG. A number of other stations co-operated by way of clearing a channel through from coast-to-coast. It was an excellent piece of work, and only one of many examples of what amateurs can do when called upon to assist in an emergency.

Calls Heard

By Francis D. Gilliland, 3621 Sutherland Road, Shaker Heights, Ohio, on 40-meter C.W.: K6LBB, CM6GT, K5AM, C8SAG, K4BU, EA4AC, VK2AZ, VK2NS, VK2ZC, VK2YC, VK2ED, VK5XU, VK4FD, VK2TK, VK3KN, VK3EG, CM7CR, K4BRN, K6JFV, VK3DD, X1BC, NY2AB, X1AA, X1AL, NY1AA, K5AG, EA8AF, VK2OJ, VK2XJ, VK4UU, VK2DU, VK3HN, CM2PW, K4AAN, CM2AN, VK7NL, EA8EG, CM8AF, EA4AO, VK7RC, VK2QP, ZL3AL, VK5LP, X2AD, X2N, X2C, EA7BE, CT1GU, VK2DA, VK3GO, VK3YP, VK3ML, VK3WY, VK5FM, VK2PT, K6KEF, VK3YO, VK2FN, VK2QN, VK3UH, ZL1HY, CM2JM, VK2YP, VK2XC, VK2FX, VK7JB, K6ESU, ZL3AN, ZL4AL, VL2GO, ZL2BN, VK3XQ, VK3DP, K4RJ, K6HZI, VK3MR, K2EL and VK3OC. On 20-meter C.W.: K5AA, PY1DI, LA1G, G8NI, G2BY, G5BJ, ON4AU, ON4DX, G5BY, VP5PZ, ON4RX, F8WB, ON4DS, F8PC, F8EX and ON4MX. On 40 meter 'phone: H17G.

By N. C. Smith, Forge House, High Street, Foots Cray, Sidcup, Kent, England, on 20-meter 'phone: W3MD, W8AVB, W2DCR, W1GPE. On 20-meter C.W.: W2FF, W3S1, OH1NR, W2BSR, LA4W, W2BSK, W1BEQ, SM6UA, W4CFD, W2DTB, W2HHE, W3DSY, ZB1E, W2AG, W1BBK, W1BX, W2AQH, ZT6M and VE1EX. On 40 meter C.W.: CN8MP, K4RT, VS7GJ, W1SL, YL2CG, SX3A, FMSENG, ZB1E, Y1PR, U5KN, VK2ER, VK3MX, ZB1C, SU1RO, VK3FD, U6AH and YR5BB. On 40-meter 'phone: EA7BE and EA7AI. On 80-meter C.W.: NY1AA, W1BIC, W2NC, W4KV, W3SN, W1IDM.

By Ronald G. Thatcher, 5 Webster Street, Middleboro, Mass., on 40-meter C.W.: VK2XJ, VK2EO, VK2WV, VK2WV, VK3DP, VK4GU, VK4FB, VK4KO, VK4JU, VK4AP, VK5FG, VK5FM, VK5MD, VK5GL, VK7JB, VK7NC, and VK7NL.

By R. W. Evans, 832 Richie Avenue, Lima, Ohio, on 40-meter 'phone: X1HA, 2RC and K1K.

By L. M. Jansen, Box 512, Lovell, Wyo., on 75-meter 'phone: Thursday morning club including W6HXP, master of ceremonies; K6MC, K6LD, W4NN, W9OK, VE2ER. Club members operate on 3,965 kilocycles.

By Ron. C. Bradley, 38 Upper Fitzwilliam Street, Dublin, I.F.S. On 20-meter 'phone: W9BK, W2BC, W3ABN, W1AAY (or I), W1AJZ, W3DBO (or W3BBO), W8GOY, W3MB (or W3MD), W3QV, W9AAO, W2JM, W2EDW, W3EHY, W2BK and W4CVN.

* Amateurs in the United States are not permitted to use telephone transmission on 30 meters.

By N. C. Smith, Forge House, Footh Cray, Sidcup, England, on 20-meter C.W.: CT3AB, W1KMN, ON4CJ, W4CQD and W2AFU. On 40-meter C.W.: VK3MR, VU2DB, VK5SU, ZL4CK, SU5NK, ZL4AL, VK4GK, W04CRL, VK2FK, V56AH, VK2DA, VK4RB, VU2IP, VU2IL, K4BRN, W4NP, W1CSC, VU3LL, VK4EI, VK5KL, VK3VW, VK3FB, U4LH, CT2BB and W1GVK.

On 80-meter 'phone: VE1EI, W4ACV, W4EUL, W1ADM and W2AIP.

On 80-meter C.W.: W3CBF, W2BMB, W1CKD, W2HVM, and W3SN.

By Albert E. Emerson, 1049 East 147th Street, Cleveland, Ohio, on 20- and 75-meter 'phone: VE1CI, VE1EX, VE1DC, CO2WZ, CO2JM,

CO2RA, W6DTX, W6IRX, W6ERT, W1KJ, W2CMJ, W2DW, W4ALO, W4CZG, W4UP, W9KVI, W7BWD, W7ARK, W5BMN, W5UN, W9GGY and W9BPK.

By Danford Adams, Kakadjo, Maine, on 20-meter 'phone: W7BNG, W6WP, W6GLI, W5BOP, W4CU, W6BYW, H17G, CO2WZ, W5BDB, G5VL, X1W, VP5PA, W6ZH, W5ZS and K4SA.

On 75-meter 'phone: W6CRX, W9PH, W5EFV, W4DU, W4BAN, W5ETF, W6HXP, W6CNE, W5BBE, W3ALI, W6BIG, W7BCU, W3UD, W3ASH and W9MN.

By Clifford Pryor, 2261 Sacramento Street, San Francisco, Cal., on 20-meter 'phone: W2HFS, W3EHS, W3ACK, W5AYF, W5ECL, W5IC, W5ZS, W5AFO, W5FJ, W5BYJ, W5EUB, W5ANU, W5DCP, W6AND, W6BOW, W7OC, W7ARK, W8GLY, W8WA, W9HV, W9ADW, W9NNO, W9FJ, W9BIF, W9DKU, W9LNB, W9MIO, W9ARK, W9LD, W9JGA, W9JOT, W9JRY, W9JLR, W9FCI, VE5HA, K6JEF, K6JFJ, CO2RA and X1AL.

By John Wojtkiewicz, 4523 St. David Street, Philadelphia, Pa., on 20-meter 'phone: CO2WZ, CO2HY, CO2LH, CO2RA, CO2KC, CO6OM, VP5PA, K6KEF, K4SA, X1W, X2AH, VE1DC, W6CNE, W6FFN, W6CQG, W6ERT, W6CRG, W6ATR, W6CIN, W6ZH, W6PT, W5BMM, W5BDB, W5ZS and W7BCL.

On 160-meter 'phone: W9BHO, W9LLX, W9MEL, W9TNY and W9DXI.

The Code Guild

(Continued from page 29)

W5DDC Herbert Leo, 1420 Hawthorne, Houston, Texas
W5BRT Ralph Cordell, Box 27, Francis, Oklahoma
W5CPV Grady L. Hardin, 132 Oak St., Hot Springs, Ark.
W6BTW John K. Maybee, 713 S. Davis St., Santa Rosa, Calif.

W7DBP F. W. Stuart, R. F. D. No. 2, Boise, Idaho
W7WE Loren C. Maybee, 3516 Hudson St., Seattle, Wash.
W7AHC C. J. Sligar, 1719 Carlisle, Spokane, Wash.
W7DAV Dewaine Hardin, Box 706, Nyssa, Oregon
W8FYS Harry Dollings, 1743 E. Main St., Columbus, O.
W8LZT Theo. Campbell, CCC-373, Camp S-119, Phillipsburg, Pa.

W8KGM Edw. J. Goodison, 300 E. Edward St., Union, N. Y.
W8EEZ Tauno M. Alanen, 512 New St. Fairport Harbor, Ohio

W8EQY Earl Gaesser, 33 Buchan Park, Rochester, N. Y.
W8FQS Philip McMunn, 29 Ramble Ave., Chautauque, N. Y.

W8MCP Charles Hedrich, 30 DeKalb St., Tonawanda, N. Y.

W8HKT F. T. McAllister, 719 Wayne St., Saint Joseph, Mich.

W8KSG Carl T. Sheaks, 404 Highland Ave., Turtle Creek, Penna.

W8MHE Charles L. Gibson, 9 Sycamore St., Natrona, Pa.
W9TE Arthur L. Braun, 5211 Brookville Rd., Indianapolis, Ind.

W9HHW Denzel Begley, Box 46, Fort Meade, S. Dak.
W9RPD A. J. Lawrence, Co. 765, CCC, Schley, Minn.
W9NIE Walter Anderson, 303 E. 18th St., Lockport, Ill.
W9LKK Sidney Schulz, 3132-4th St. S. E., Minneapolis, Minn.

W9CWA Charles J. Piconne, Mancos, Colorado
W9LUS Clarence W. Read, 3401 S. Parnell Ave., Chicago
W9RVM Frank O'Neill, 5469 Beacon Ave., St. Louis, Mo.
W9OKS F. G. Ludvik, 307 Railroad St., Eau Claire, Wis.
W9GYP J. N. Kessler, 2412 Edina Blvd., Zion, Illinois

Press Schedules

The following stations transmit press on regular schedules. Copying them is the best form of practice for speed and copying behind, especially if you use a "mill" and can step along with them. Just to listen to any of these stations, without copying, is fine reading practice.

GMT Call	Kc.	Place
0000	WFD	10460 New Orleans
0100	WPN	8690 Garden City, L. I.
0300	KUP	6440 San Francisco
0330	VAS	8410 Louisville, N. S.
0415	WSC	8430 Tuckeron, N. J.
0530	KUP	6440 San Francisco
0600	KFS	8370 Palo Alto, Cal.
0800	KUH	8345 Manila
0900	KUP	6440 San Francisco
1200	GIC	19640 Rugby, England
1300	KTK	6400 Mussel Rock, Cal.
1330	WFD	10460 New Orleans
1600	RKD	10657 Moscow
1700	KUH	8345 Manila
2000	GIC	8640 Rugby, England
2030	DIS	10150 Nauen, Germany
2148	GIC	8640 Rugby, England
2230	KTK	8640 Mussel Rock, Cal.
2230	ZLW	5700 Wellington, N. Z.
2350	DIS	10150 Nauen, Germany

Walter Germann, 905 E. 169th St., N. Y. C., reports the latest schedule of WCX as follows: 7810 kc.—14:00, 17:30, 22:00 and 01:30, G.M.T. This is a good px stn for all you fellows in the East, or anywhere, as for that.

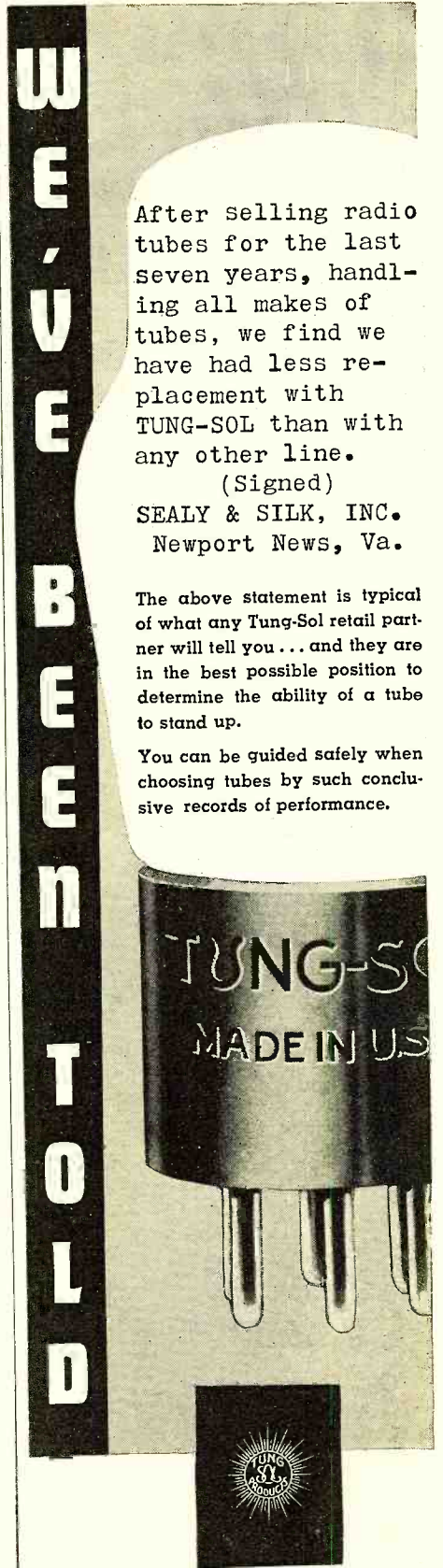

After selling radio tubes for the last seven years, handling all makes of tubes, we find we have had less replacement with TUNG-SOL than with any other line.

(Signed)

SEALY & SILK, INC.
Newport News, Va.

The above statement is typical of what any Tung-Sol retail partner will tell you... and they are in the best possible position to determine the ability of a tube to stand up.

You can be guided safely when choosing tubes by such conclusive records of performance.

TUNG-SOL

Tone-flow radio Tubes

TUNG-SOL RADIO TUBES, Inc., Newark, N. J.
Atlanta, Boston, Charlotte, Cleveland,
Chicago, Dallas, Detroit, Kansas City,
Los Angeles, New York

WHAT'S NEW IN RADIO

WILLIAM C. DORF

USE

Real TONE and "SOCK" for Outdoor Amplification!

Type 26-B "U-S-E" Amplifier is standard everywhere for handling large outdoor crowds. Recently installed in Braves' Field, Boston, and University of Minnesota Stadium. Carried by major carnival companies because of its sturdy construction and high power output.

What-ever You Need

— from transformer kits to rack assemblies and Cathode Ray test instruments.

Write for our new literature and prices.

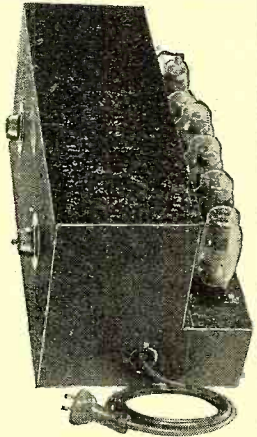

UNITED SOUND ENGINEERING CO.
Manufacturers of Specialized Sound Equipment
2229 University Avenue, Saint Paul, Minn.

Train for RADIO IN 10 WEEKS AT COYNE

The great Coyne Shops in Chicago have a world-wide reputation for training ambitious fellows for this big-pay field in only 10 weeks. Then they get behind you to assure success by giving you life-time employment service. By my new plan YOU can take advantage of their wonderful method of learning-by-doing NOW—no need to lose time and money while you strive and save to raise the necessary tuition.

I WILL FINANCE YOUR TRAINING



You can get your training first—then I'll give you over a year to pay me back in small monthly payments starting FIVE MONTHS from the date you start school. If you will write to me at once I will send you complete details of this sensational new plan, together with the Big Free Illustrated Book telling all about COYNE and how many earn while learning and training you can get there without book study or useless theory.

H. C. Lewis

COYNE RADIO & ELECTRICAL SCHOOL
500 S. Paulina Street, Dept. B5-3K, Chicago, Illinois

MR. H. C. LEWIS, President
500 S. Paulina St., Dept. B5-3K, Chicago, Ill.
Tell me how you will finance my training at COYNE and send me the BIG FREE Illustrated Book on RADIO.

NAME _____
ADDRESS _____
CITY _____ STATE _____

The New EXPLORER All-Wave Power Converter

Brings in foreign short wave stations on the loud-speaker of ANY regular broadcast receiver with amazing volume! New "A. M. O." circuit (described May "Radio News") operates as combined converter and pre-amplifier. Covers 4 bands from 15 to 200 meters. Features include signal indication, dual regeneration, headphones outlet. Users report powerful world-wide reception where expensive all-wave sets fail! Sold on money back and foreign reception guaranteed. Price, less tubes, \$10.95. Literature FREE.



RIM RADIO MFG. CO. 691 Grand Street, Brooklyn, N. Y.

Thermometer-Hygrometer

This Muter "Telaire" device was developed primarily for use in schools, offices and homes where, for reasons of comfort and health, it is desired to maintain a check on both temperature and humidity.

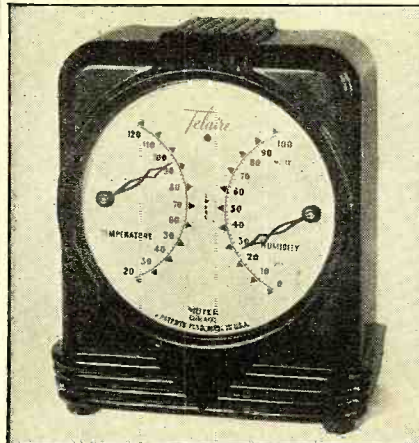

In the radio field this instrument finds two applications: (1) for DX'ers who wish to include a record of weather observations in their reception logs, and (2) as a gauge of artificial weather conditions developed to test the ability of receivers and parts to withstand extreme variations of heat and humidity. The attractive combination instrument is of the spring type, and is housed in a bakelite case with a convex glass face.

New Set With Dual-Wave Coverage

The Howard 6-tube "World Wide" two-band receiver employs the following tube equipment: one 6C6, one 76, one 6D6, one

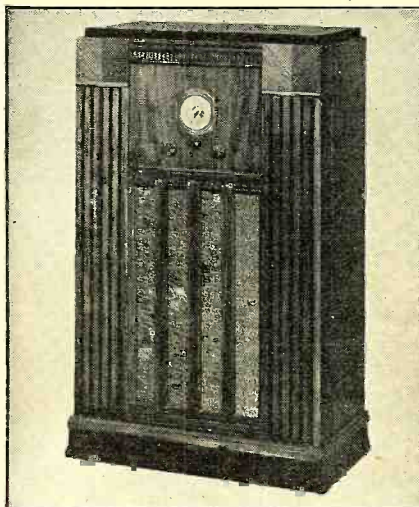

75, one 42 and one 80. In addition to covering the regular broadcast and upper police bands, it provides reception on the short-wave ranges from 15 to 55 meters.

Portable Mobile P. A. System

Announcement is made of the new Operadio model 62 mobile 6-volt, storage-battery-operated sound reproducing system, with the amplifier, turntable and controls all enclosed in a single carrying case. Using Class A audio amplification, it has

a power output of 18 watts and the tube equipment comprises two 76's and two 2B6 type tubes. A sound system of this kind

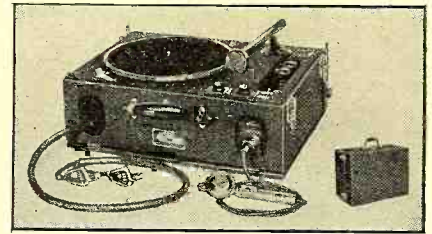

should have wide application, i.e. in rural dance halls, picnics or other gathering places where electric line supply is not available.

Replacement Vibrators

An announcement of interest to dealers, servicemen and owners of auto-radio sets was recently received from P. R. Mallory and Company, that their new line of replacement vibrators for motor-car B eliminators is now complete with many new



types, available at new low prices, to meet every auto-radio receiver replacement vibrator requirement. The motor-car sets used in the Buick and Ford, also the Crosley and Zenith sets, are just a few of the motor-car receivers taken from a long list for which the new replacement vibrators are now available.

Eight Watt Amplifier

The new 6-tube Radolek amplifier designed for medium-sized public-address installations is provided with two input

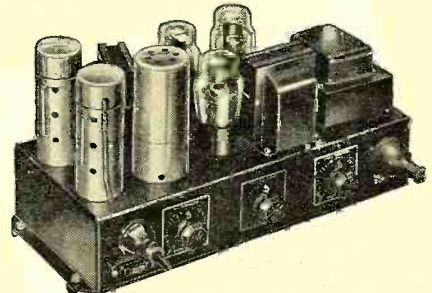

channels with mixing and fading equipment and is suitable for operation with as many as 7 dynamic type speakers. Low hum level, fine quality and rigid mechanical construction are among the features of this new equipment.

Auto-Radio Vibrator Tester

The Electronics Laboratories recently announced a new instrument for testing all makes of motor-car radio vibrators. The instrument is direct reading and rates vi-

brator performance as either good or bad. Another unique feature is a frequency indicator lamp that glows if the vibrator under test is producing undue r.f. interference.



The tester may also be used to test the buffer condenser used across the secondary of the transformer and type 84 rectifier tubes.

New Short Wave Converter

A 4-tube short-wave converter of new design is now being produced under the

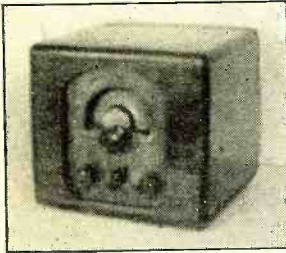

name of "Receptor" by Wells-Zimmer Company. The whole unit is contained in an attractive wooden cabinet measuring 8 by 9 by 8 inches. The tuning range is from 18 to 80 meters in three separate bands. The features of the Receptor are: simplified band-spread, all-band calibration on a single dial and the use of super-regeneration.

Doublet Antenna Kit

The new Brach "Pur-A-Tone" all-wave aerial kit contains all the necessary parts for a complete doublet antenna with twisted wire transmission line. The kit comprises 60 feet of No. 7-24 stranded



antenna wire, 50 feet of stranded rubber-covered twisted and braided lead-in wire and coupling transformers for both the antenna and receiver ends of the transmission line. The necessary hardware is also included.

Portable Recorder

This portable sound recorder made by the Radiotone Recording Company is an instantaneous recording unit designed to meet special requirements of broadcast stations, recording studios, for recording

sound effects, and many other applications. Some of the features incorporated in the recorder are: belt-driven positive overhead screw feed mechanism, an adjustable cut-

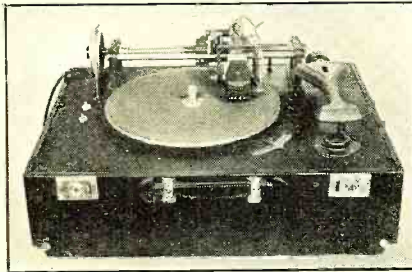

ting head carriage, counterbalanced cutting head and special positive-speed recording motor. The dimensions are 23 by 18 by 12 inches and the weight 45 pounds.

Cathode-Ray Oscillograph

A new cathode-ray oscillograph type TMV-122B has recently been placed on the market by the RCA Mfg. Company. It includes two power supplies (one for the cathode ray tube and one for the amplifier) a vertical and a horizontal amplifier, a saw-tooth frequency generator and six tubes including the 906 type 3-inch

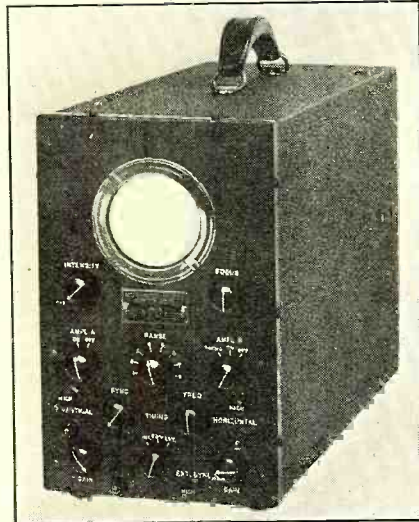

cathode-ray tube. The frequency range extends from 20 to 15,000 cycles and permits the examination of a single cycle image at frequencies up to 15,000 cycles or a multiple image up to the limit of the amplifier—90,000 cycles.

A.C.-D.C. Personal Receiver

For semi-portable use, American Bosch offers the model 402 receiver, a 5-tube universal superheterodyne. In its attractive wooden case it measures only 10½ by

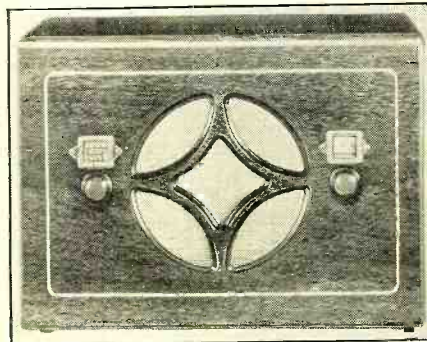

7½ by 5¼ inches overall. A built-in an-
(Continued on page 64)

"That Sylvania Manual is swell . . . glad I bought it"



Take a tip from this radio man . . . send for your copy of this handy service booklet today . . .

That's right . . . just a dime for this valuable booklet that's crammed with useful information for every radio service man. 35,000 have sent for it already and a lot of them have written in to tell us that this is one coupon they're certainly glad they clipped.

Sylvania has compiled this book for service men . . . men who know radios, but who are always ready to learn more about them. 104 pages of information about tubes . . . descriptions of them, with complete circuit applications. Helps you recognize problems that you might run into any day . . . and helps you solve them.

Don't wait . . . send your dime with this coupon today, and you'll see what a gold mine of information this book is.

Hygrade Sylvania Corporation. Makers of Sylvania Tubes, Hygrade Lamps. Factories at Emporium, Pa., Salem, Mass., and St. Mary's, Pa.

Sylvania
THE SET-TESTED RADIO TUBE

10c.—Technical Manual—10c.

Hygrade Sylvania Corporation Emporium, Pennsylvania A-24

Please send me the new Sylvania Technical Manual. I enclose 10c in stamps.

Name

Address

City State

Train Now for New RADIO Opportunities

Get Into a Line Where There's Action—Every Day—And a Payday Every Week—You Be the Boss!

Analyzer & Resistance Tester—Latest Design—Yours Without Extra Cost

Right now while hundreds are looking for work where there isn't any, the radio service field can use trained men. With the proper training and the necessary equipment, you can enter this field and make a comfortable living. We include with our course this modern set analyzer and trouble shooter without any extra charge. This piece of equipment has proved to be a valuable help to our members. After a brief period of training, you can take the set analyzer out on service calls and really compete with "old timers." We show you how to wire rooms for radio—install auto sets—build and install short-wave receivers—analyze and repair all types of radio sets—and many other profitable jobs can be yours. Teaching you this interesting work is our business and we have provided ourselves with every facility to help you learn quickly yet thoroughly. If you possess average intelligence and the desire to make real progress on your own merits, you will be interested.

ACT NOW—MAIL COUPON

Start this very minute! Send for full details of our plan and free booklet that explains how easily you can now cash in on radio quickly. Don't put it off! Write today! **Send Now!**

RADIO TRAINING ASSN. of AMERICA
Dept. RN 57, 4513 Ravenswood Ave., Chicago, Ill.
Gentlemen: Send me details of your Enrollment Plan and information on how to learn to make real money in radio quick.

Name.....
Address.....
City..... State.....

THE Only 100% RADIO CATALOG

IT'S **Free** 1935 **RADIO** CATALOG

THOUSANDS OF PARTS
SET-BUILDING KITS
TEST INSTRUMENTS
PUBLIC ADDRESS
SHORT WAVE GEAR
ALL-WAVE AUTO
BATTERY RADIOS

PARTS—TUBES
TEST EQUIPMENT
SERVICEMEN'S SUPPLIES, ETC.
ENROLL

ALLIED RADIO CORPORATION

833 W. Jackson Blvd., Chicago, Ill., Dept. M
Send me your FREE Spring & Summer Catalog.

Name.....
Address.....

NEON

TATTELITE TESTER "tells the tale"

Tests for blown fuses, condensers, or resistors, r.f. peaks and wave length, polarity, open circuits, live lines, defective spark plugs, etc. 100 uses—pocket size. With instructions—postpaid, a \$1.00 bill.

Send 10c for catalog of other Tattelites, Instrument, Aircraft and High Voltage Littelfuses, Radio Fuses, Mtgs, etc.
LITTELFUSE LABS.
4521 Ravenswood, Chicago, ILL.

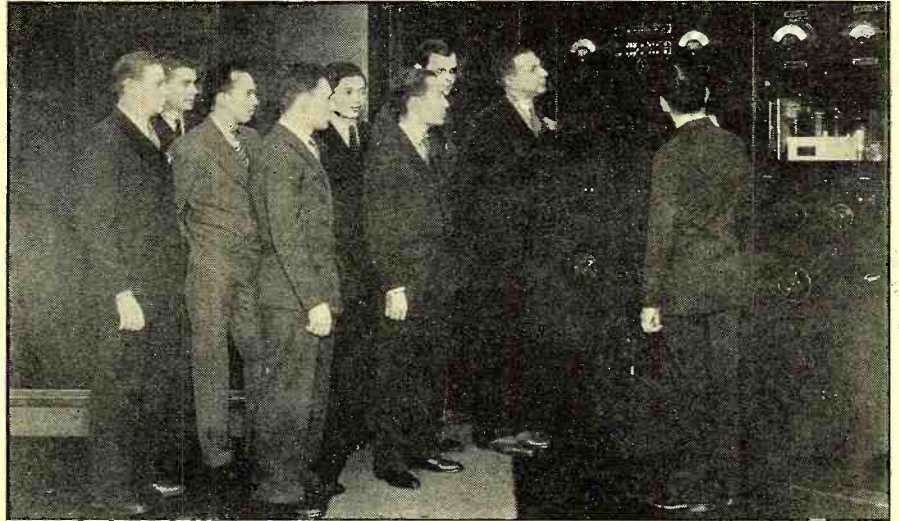
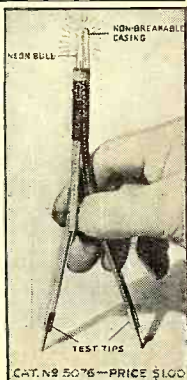

QRD? QRD? QRD?

CONDUCTED BY GY

THE ultimate possibility of flashing entire pages of hand or typewritten letters by radio facsimile was discussed in the annual report of the RCA. Progress in the facsimile transmission has reached a stage where communication by the square inch instead of the traditional Morse code method of dots and dashes on a word basis has been achieved and demonstrated in the experimental stage. This development promises new point to point communication services and new broadcast services to the home of pictures, printed matter and other visual material.

DAVID SARNOFF, in commenting on high speed facsimile, said recently: "Today we see radio stepping into a new field of expansion . . . micro-wave facsimile. And I believe the day is not so far distant when radio will dip into the mail bag. If a letter is worth the time required for dictation, for the stenographer to write, for re-reading by the sender, then the stamp and let us say a month for arrival in Australia, then it is worth a little more to flash it across the world for quick delivery and an answer. I believe thousands of facsimile letters and messages will fly between cities and from country to country by facsimile radio." He emphasized that he was talking about ultimate prospects, not immediate plans. Facsimile on normal short waves already has proved its usefulness in flashing news, pictures and printed matter across the ocean. It is commonplace now for pictures of news events in Europe to appear in American newspapers a few hours after their occurrence. Micro waves, so small that they are measured in inches, are practically free from static. Quasi-optical in character, they carry about as far as the eye can see. That means that from the top of a sky-scraper they will reach to the theoretical horizon. Relay stations shunting the signals on automatically are depended upon to overcome this limitation of distance. It can be seen that the real mystery of radio still lurks in the ether, not in the man-made apparatus. As we learn more about the medium through which radio waves travel, improvements follow in transmitting and receiving apparatus. Some operators will take this foregoing to mean that it is the handwriting on the wall. Others, less informed, will forget that anything like this was ever mentioned, if and when telegraph

becomes a thing of the past by replacement with newer methods.

Referring to our heading this month, the illustration shows a group of well-known radio editors being shown around the new 50 kw. WOR equipment and plant by Charles Singer, Engineer (standing with his back to the camera). In the group are, left to right: Melvin Spiegel, J. K. Lagemann, Fred Sammis, E. A. Grunwald, Sam Kaufman (know him???), A. Stein, E. V. Heyn, Ed Lewis and—Mr. Singer.

It looks like Merv Rathborne is not going in for national acclamation, as his recent letter stating his withdrawal from nomination for secretary-treasurer of the ARTA shows. He states that the action has been carefully considered. It is taken to permit him to run for secretary of the San Francisco local. All we can say in this matter is that the organization is losing an able worker and an honest man.

Well, more raises in salaries have come about, with the Grace Line making a minimum wage of \$100, and all passenger ships are included in the three-man, eight-hour day set up. The Grace Line has always been fair in its dealings with operators and there is no doubt it must be getting 100% cooperation from its operators.

One of our major radio companies recently discharged a marine superintendent as a result of evidence produced by the ARTA proving the official guilty of selling jobs to marine radio operators. He worked his system by asking operators for a loan, but these so-called loans were never repaid.

Brother Chester Maik, after a trip ashore, returned to the Trawler Shawmut, relieving Bro. Donny Thomas, who sailed for New Orleans on a Greyhound bus. He is to take a job with the Southern Harvester Company of Memphis. Although Donny claims he is quitting the sea for good, he expects to keep in touch with the boys. And as for the trawlers, he sez that even if they haven't got the wooden ships of the past, they still have the iron men on the fishing fleet out of Boston. Good for you, Donny, and keep the rudder dead center in the future. . . .

There has been no appreciable change for the better in the shipping world at this port, our Southerner advises us. The Todd

Drydock Company seems to be bringing more ships to this port since they took it over, but most of them are Standard Oil ships and have East Coasters aboard.

Mr. A. P. West is an operator with about nineteen years' experience. He is minus a right arm, but is considered to be a first-class man and able to copy WNU press on the mill with his left hand. Nevertheless, West got into bad standing with the radio companies by getting into trouble on some of his vessels. Some time ago he was in a destitute condition and some of the boys helped him with a few to get him going again. The last he was heard from was in Savannah, Georgia, where he sez he turned down about ten offers to "scab" on Merchant & Miners S. S. Co. ships. He sez that from eleven P.M. until nine A.M. he was beset with fanciful offers of employment to board one of the vessels. He was the only man with a First Class ticket around at the time. But Brother West, although in dire need of a job, steadfastly refused to align himself with that blacklist of scab operators. A good man, what say?

Brother T. R. McElroy, who set a world's speed record by receiving 56½ words-per-minute in Chicago in 1933 recently outdid himself at a professional showing by officially receiving 77 words per minute. He copies this on a mill from a sealed tape and was checked by three members of the Cape Cod Radio Club. He copied this tape of plain language for three minutes without error and also transmitted perfect signals for five minutes at a speed of forty-seven words per minute. That is stepping some!

In reference to this column's remarks anent radio ops and SOS transmission, Mr. H. N. Umbarger of Mansfield, Ohio, tells this one which we think will interest all . . . "Your article makes me think of another angle—where the op holds off sending the SOS after the Captain had ordered it dispatched. This actually happened on Lake Huron in 1914. Herb Rodd was operator on an old passenger-packet steamer which proceeded to go aground one night not so far from Alpena, Mich. He was told to send out a call for help, but was not worried and apparently thought the skipper yellow and just put it off. The call was finally sent out about 2:00 A.M., and do you suppose it was heard by any American ops? Heck, no, they were all asleep, but the Canucks snapped right back. Nothing serious developed, as she was lightered and released by the wrecking tub, *Favorite*, on which I was stationed."

Another fan writes in . . . "I have often wondered if all skippers throughout the world have been as antagonistic to radio as have the majority of skippers in the Lakes district. I recall going aboard a newly-equipped freighter and being informed on the first pay-day that it was a lot of foolishness to have a radio, that I wouldn't be there next season, etc. . . . I answered that I probably wouldn't, but that the equipment would remain as the owners had signed a 3-year contract. . . . Late that same season I copied an NAA weather report and storm warning for the entire lake region and handed the copy to the skipper just as we were nosing out into the lake, bound north. He read it skeptically, but condescended to have a look at the barometer. Discovering that the bottom had dropped out, he whistled, but said, "Well, we'll keep going." We did, that is, part of the night, when we were blown around for the third time and they couldn't get nosed into wind again.

A break in the snow storm at daybreak disclosed a shore line and by dint of three anchors and a "full astern" engine, we managed to stop, possibly a quarter mile from a nice, smooth, rocky bottom Grindstone Point. I think he changed his mind that time, though.

And that, me hearties, is the general consensus of opinion. That the skipper is a law unto himself, without benefit of aid from any quarter except in dire distress and that of God. The modern and well-read skipper of the present is not that way, but the old-timers are and live in a haze of reminiscences of the past with wooden ships, etc. . . . In every ocean there swim different kinds of fish and in the radio operating profession there are a few bad, so if their experience has been with a bad one, should all be condemned? Nay, nay, but it requires technique to cure them of this, and who wants to go to that extreme, and anyway the skippers won't read this blurb, so what . . . so adios and ge . . . 73 . . . GY.

Dots and Dashes

(Continued from page 3)

the Radio Corporation of America with the flight's sponsors in equipping the gondola with two-way voice equipment.

Special radio equipment designed by RCA-Victor and the Radiomarine Corporation, similar to the NBC equipment of the 1934 flight, will be built. An 8-watt transmitter will be used in the gondola.

Captains Albert W. Stevens and Orville Anderson will attempt to take the balloon up 75,000 feet to a new record. Stevens and Anderson both participated in the 1934 flight with Major W. E. Kepner.

The new balloon will be 25 percent larger in cubic contents than the ill-fated "Explorer" used last year. Also, helium will replace hydrogen for inflation of the 3,000,000-cubic-foot balloon. The new gondola will be eight inches larger in diameter, allowing more space for scientific equipment.

The balloon will be taken to the strato bowl during May and various preliminary broadcasts will originate at the site between that date and the flight.

Listening post observers will also have an opportunity to stand by for signals from two experimental ultra-short wave transmitters which will send out continuous signals from the balloon to further study the theory of distance covered by ultra-high frequencies. These two sets will be self-contained and suspended about 100 feet below the gondola. Their respective frequencies will be 56,000 kilocycles (5½ meters) and 112,000 kilocycles (2.7 meters). Both of the outgoing signals will be modulated.

A New Station in Afghanistan

KABUL, AFGHANISTAN—Two new broadcast stations have been under construction here for some time. Finally it has been established that these two transmitters will not be sufficient and it was decided to build an additional more powerful station.

Jeloy Changes Its Frequency

OSLO, NORWAY—The well-known Norwegian short wave station LKJ1 at Jeloy, has changed its frequency from 9540 kc. to 9572 kc. in order to avoid interference with the new German short wave station DJN. LKJ1 works on this frequency in the morning.

NATIONAL XR-20 COIL FORMS

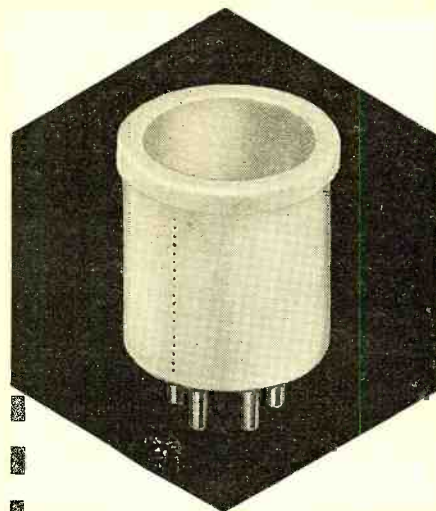

For short-wave receiver construction and experimental work when a small coil form at a low cost will fill the requirements. The XR-20 Coil Forms are made of Steatite, well known Low Loss National Dielectric. They are drilled for leads and left unglazed to provide a tooth for coil dope. Diameter 1½". Made with 4, 5 or 6 prongs and fit standard Tube-Sockets. List Price, XR-20, \$.35.

NATIONAL R-39 COIL FORMS Machinable and drillable because made of R-39, outstanding exclusive National Dielectric. Length 2¼". Diameter 1½". In 4, 5 or 6 prong types. List Price, XR-4, XR-5 or XR-6, \$.75 each.

List prices subject to 40% discount when purchased through an authorized NATIONAL Distributor.

USE COUPON BELOW

COUPON

National Company, Inc.
Malden, Massachusetts

Gentlemen:
Please send me your new catalogue No. 240. I enclose 6c to cover mailing costs.

Name

Address

.....

RN-7-35



NO WORSE THAN BEING WITHOUT RIDER'S MANUALS

Equipment! You can't catch whales with angle worms; you can't do this servicing job RIGHT, without the best Manuals... RIDER'S... remarkable for their complete coverage. More solid, usable dope... and it's permanent, not transitory!

- Vol. I.....1000 pages...\$7.50
- Vol. II.....800 pages...6.50
- Vol. III.....1070 pages...7.50
- Vol. IV.....1060 pages...7.50
- Vol. V.....1200 pages...7.50
- Servicing Superheterodynes.....1.00

NEW

Rider's Auto Radio Manual VOL. II IS READY, with 416 pages of specialized dope, including nearly 70 manufacturers. No duplication 'twixt this and Vol. I. Get No. II, servicemen! Vol. I, 350 pages Vol. II, 416 pages
\$3.50 \$3.50

The Cathode Ray Tube At Work

Can you afford to service modern sets by antique methods? Up-to-the-minute data, showing all the ins and outs for using the cathode-ray oscilloscope and making greater profits from servicing... It's Rider's.
 320 pages
 6 x 9 inches **\$2.50** postpaid

FREE—"Successful Servicing," our 8-page monthly house organ. Are you on our mailing list?

JOHN F. RIDER, Publisher
 125 W. 40th St., New York City

WHEN CHOOSING A RADIO SCHOOL

RCA Institutes, with its reputation firmly established by 26 years service, is an institution recognized as an important factor in the radio industry.

Whether elementary radio principles or advanced subjects, sound applications, mathematics or practical radio engineering, RCA Institutes is prepared to give you the instruction you need.

Resident Schools at New York and Chicago

Modern Apparatus and Laboratory Equipment—Conveniently Located—Day and Evening Classes—Tuition Rates \$3 to \$10 Weekly.

Extension courses for home study on convenient "no obligation" plan. Examination and technical advisory services. Free post-graduate practical training at resident school with modern equipment under instruction of engineers.

Write for Catalog.

RCA INSTITUTES, Inc.

Dept. RN-35

75 Varick Street
 NEW YORK

1154 Merchandise Mart
 CHICAGO



Recognized Standard in Radio Instruction Since 1909



THE TECHNICAL REVIEW

CONDUCTED BY ROBERT HERTZBERG

Review of Articles in the April, 1935, Issue of the Proceedings of the Institute of Radio Engineers

The Application of Superheterodyne Frequency Conversion Systems to Multi-Range Receivers, by W. A. Harris. The effects of coupling between oscillator and radio-frequency circuits are considered, it is shown that such coupling may occur as the result of space-charge variations in the converter tube. The use of r.f. amplification to reduce noise is suggested.

A Study of Television Image Characteristics, by E. W. Engstrom. This paper discusses the determination of "frame frequency" in terms of flicker characteristics. Conclusions are reached regarding several means of minimizing flicker.

General Considerations of Tower Antennas for Broadcast Use, by H. E. Gihring and G. H. Brown. A series of measurements using small models of actual antennas resulted in interesting data, which checked very closely with the performance of the full-sized structures. Several types of recently installed antenna towers are shown to be less effective than expected, particularly with regard to reduction of sky wave and fading.

Experiments with Directivity Steering for Fading Reduction, by E. Bruce and A. C. Peck. This paper describes experiments made with a "steerable" directive antenna during reception of transoceanic short-wave signals. The results demonstrate that sharp, angular discrimination is a sound method of combating fading that is due to phase interference.

Steel-Cylinder Grid-Controlled Mercury Arc Rectifiers in Radio Service, by S. R. Durand. The use of mercury seals in this type of rectifier is described, and the operation of various auxiliaries, such as vacuum pumps, vacuum meter and ignition-excitation equipment, dealt with.

The Quadrature Oscillograph, by Jesse B. Sherman. This is an electro-mechanical oscillograph galvanometer which is capable of deflection along two mutually perpendicular sets of coordinate axes.

Review of Contemporary Literature

A 50-KW. Radio Transmitter of High Quality, by J. C. Herber, and *Controlled Radiation for Broadcasting*, by J. F. Morrison. Bell Laboratories Record, April, 1935. Both these articles deal with the new WOR transmitter.

Seven-Meter Broadcasting—One Year's Experience. Electronics, April, 1935. The station referred to is WBEN-WBXXH, operated in Buffalo. The station is described, and the importance of antenna height is emphasized.

The Inductive Glow-Discharge Oscillator,

by Winston E. Kock. Radio Engineering, April, 1935. An analysis of the intermittent-glow discharge oscillator, with inductance inserted in the condenser arm and operating in the neighborhood of resonant frequency, is presented.

Class AB Amplifier Design, by Maurice Apstein. Radio Engineering, April, 1935. The author states that primary consideration should be given to the design of the components and less attention to the circuit.

Do You Want a Kilowatt? by Don H. Mix. QST, April, 1935. A high-power band-switching 204A amplifier requiring only 50 watts for excitation.

The Elimination of Interstation Interference, by J. Robinson. The Wireless Engineer, April, 1935. A system is described which employs a series of aerials with highly selective reception at each aerial, the rectified effects being combined at a convenient point. The idea is applicable to both short and long waves.

Voltage Dividers, Their Application and Design; Calculating the Current-Carrying Capacity of Resistors; Condenser Leakage and Its Effect. These three articles, appearing respectively in the January, February and March, 1935, issues of the *Aerovox Research Worker*, are of value to servicemen, amateurs and experimenters. They are clearly written and contain useful information for everyday applications.

Noise-Suppression Antennas, by William F. Osler. Service, April, 1935. An explanation of how a twisted-pair transmission line, used with a doublet antenna, reduces noise in the receiver.

Free Radio Log for the "Hams"

Amateurs will be glad to know that the Weston Electrical Instrument Corporation has just brought out a handy Radio Log for amateur stations. The book contains the new system for reporting signals, a Time Chart and also some notes on transmitting circuits. This valuable log book is available only to licensed amateurs. Address requests to RADIO NEWS, 461 Eighth Avenue, New York City.

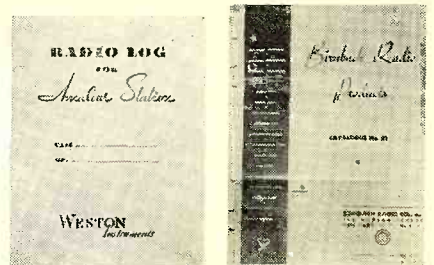

New Parts Catalog

A new 16-page catalog which features the complete Birnbach line of all-wave receiving and transmitting antenna equipment. The book gives detailed descriptions with illustrations on their large variety of antenna insulators, aerial and hook-up wire of all sizes and descriptions, shielded microphone cables, auto accessories, and hundreds of other items for the serviceman, ama-

teur, manufacturer and experimenter. Through a special arrangement these catalogs are made available, free to our readers. Simply address requests to RADIO NEWS, 461 Eighth Avenue, New York City.

Vacuum-Tube Voltmeter Measurements

Servicemen and experimenters who are not familiar with the vacuum-tube voltmeter will find an excellent explanation of its operation in this 8-page folder published by the Clough-Brengle Company. Diagrams and detailed procedure for using the vacuum-tube voltmeter for various radio purposes are included. Readers can obtain a copy of this bulletin free of charge by writing to RADIO NEWS, 461 Eighth Avenue, New York City.

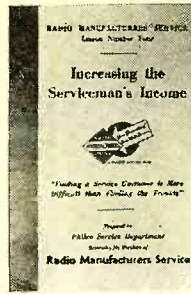

Valuable Information for the Serviceman

Through the courtesy of Philco Radio & Television Corporation, servicemen can obtain a copy of a book entitled "Increasing the Serviceman's Income." This is a subject in which all men engaged in service work will be interested. The only requirement necessary in obtaining this book is that all requests be written on letterheads indicating that the reader is a bonafide radio serviceman. Address requests to RADIO NEWS, 461 Eighth Avenue, New York City.

Transformer Bulletin

RADIO NEWS offers through the courtesy of the American Transformer Company a 32-page booklet which lists the complete line of AmerTran



De Luxe audio and power transformers and numerous other products. It contains diagrams and useful technical data. To obtain this catalog simply send in your request to RADIO NEWS, 461 Eighth Avenue, New York City.

Radio Booklet Offers Repeated

For the benefit of our new readers we are repeating below a list of the valuable technical booklets and new 1935 radio manufacturers catalog offers which were described in detail in the June 1935 issue. These booklets (J1 to J9) are available to our readers without charge. Simply ask for these booklets by code designation and send in your request to RADIO NEWS, 461 Eighth Avenue, New York City. The list follows:

- J1—Information on the Cornish Wire Company "Noise-Master" Antenna Kit. Free.
- J2—Booklet describing the technical features of the Hallicrafters' "Super-Skyrider" short-wave superheterodyne. Free.
- J3—New 1935 catalog of the Hammarlund Manufacturing Co. Free.
- J4—Resistor catalog of Electrad, Inc. Free.
- J5—Booklet on tube testing prepared by Supreme Instruments Corp. Free.
- J6—"Practical Mechanics of Radio Service," issued by F. L. Sprayberry. Free.
- J7—New 1935 parts catalog of Alden Products Co. Free.
- J8—Practical ham antenna design folder and leaflet on a new auto-radio under car antenna system, published by Arthur H. Lynch, Inc. Free.
- J9—Information on new radio courses given by the Capitol Radio Engineering Institute. Free.
- J10—"Radio Noises and Their Cure." A 75-page book. Price 50 cents.

Import Duties in Liberia

MONROVIA, LIBERIA—Effective February 1st, 1935, the new Liberian Customs Tariff increased the duties on a large number of commodities, but removed the duty on radio receivers and accessories.

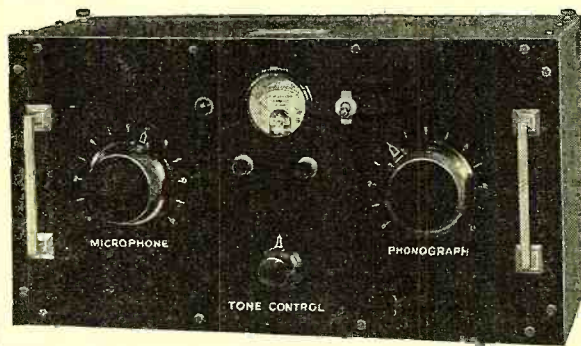

NEW!
Amplifiers
Complete
in One Unit!

Series A-30 and B-50

Now! You can save time—effort—make more money—with these NEW Amplifiers, for large outdoor or indoor installations. High output! Tone quality! Performance! Power output—A-30, 30 watts; B-50, 50 watts.



NEW
Catalog
Send
for
Copy

More Jobs! More Profits!
No fuss. No bother. Webster advanced engineering design simplifies sale and installation. All accessories totally enclosed in well ventilated, attractive case. New products—new features of design—have been added to the Webster-Chicago line. Write for Details—Today!

THE WEBSTER COMPANY

3826 West Lake St.
CHICAGO, ILL.

THE Crystal

CONTROLLED

7-TUBE SHORT WAVE RECEIVER

The finest short wave equipment that can be built. The CRYSTAL FILTER CIRCUIT, controlled by a variable knob on the front of the set, gives absolute one signal selectivity—without affecting sensitivity! PLUS the drastic reduction of man-made static. It is revolutionary! Write for details.

THE HALLICRAFTERS, INC.
3001-H Southport Ave., Chicago, U. S. A.

THE Super SKY-RIDER

TURN SCRAP INTO MONEY

The new and revised edition of "Auto Power" with all the original specifications and ten new ones is now off the press. Convert old generators into A. C. and D. C. generators and motors with voltages of 6 to 406 volts, for power, light, welding, and radio operation. Create new generators adaptable for home, automobiles, or trucks. They can be driven by fan belt, wind or water. This book, with complete illustrations, tells you how easily and economically these changes can be made. Also instructions for rewinding auto armatures. 350 definitions of electrical terms, etc. Already used and endorsed by thousands. Price \$1.00 postpaid.

AUTO POWER Dept. A 414 S. Hoyne Ave. Chicago

INTERNATIONAL DX

3-tube AC-DC ALL-WAVE **6.75**

Complete kit with speaker, coils 13-220 and diagram. Wired, extra... 1.75

Matched tubes... 2.25

Broad-band coils... .75

Metal cabinet... 1.95

Excellent foreign reception

EXPERIMENTAL RADIO LABS.

LITTLE CHUM

Single-tube AC-DC-Battery all-wave kit with cabinet, coils 40-500 and instructions

Send 10c for Data, Diagrams, etc. **4.99**

Wired, extra... 1.25

Elect. or Batt. tube... 1.00

Earphones... 1.50

168 Washington St.
NEW YORK, N. Y.

PORTABLE

Mr. G. D. Quill, 650-6 Ave., San Francisco: I received the International DX and am more than pleased as I receive JYN Tokyo, etc. Mr. Van B. Conner, 5150 Pleasant Run Blvd., Indianapolis: The International DX is sure a fine kit. I received Europe, Asia, S. A., etc.

RADIO or MORSE

Codes are easy to learn when you have an INSTRUCTOGRAPH Automatic Code Teacher. Book of Instructions explains each step, just as an instructor would do. Machines for sale or for rent at very attractive terms. Write TODAY for full details. No obligation.

Instructograph Company, Dept. NR-7
912 Lakeside Place, Chicago, Ill.
Representatives for Canada—Toronto
Radio College of Canada, Ltd., 863 Bay St.

MAKE EXTRA MONEY
INSTALLING EARPHONES
for the **HARD** of **HEARING**
in Churches, Theatres, etc.

WRITE **TRIMM** RADIO MFG. CO.
Dept. RN7
1528 Armitage Ave., Chicago, Ill.



5-10-15-20 Watt
RESISTORS

... smaller than a Cigarette!

Genuine wire-wound vitreous-enamelled units reduced to most compact dimensions. Nothing sacrificed except troublesome bulk. Another Aerovox engineering achievement!

Quality wire... crack-proof refractory tubing... precisely wound. Wire ends brazed to lugs... pigtailed soldered to terminal bands... stiff wire leads. Heavily coated with vitreous porcelain enamel

... permanent seal... moisture proof and damage-proof. Conservatively rated... adequate heat dissipation... longest service life. Just install them and forget them!

Get the Facts! New 1935 catalog for complete resistor and condenser line. Also sample copy Research Worker. Remember, AEROVOX means more quality for less money.

AEROVOX

78 Washington St. CORPORATION Brooklyn, N. Y.

NEWER THAN TOMORROW!

Leading the parade of all wave receiver development, the MASTERPIECE is the most advanced radio receiver in the world. It has vitally important engineering features found in no other receiver whatsoever. As for results, it has conclusively proved itself the champion of champions.

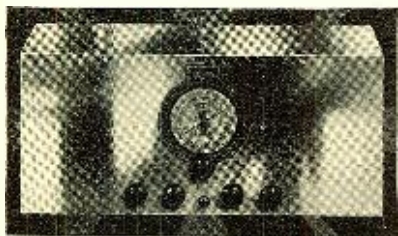

But why remain in the dark... send for complete technical, performance, and free trial guarantee details of the most modern receiver in the world... get the "why" of MASTERPIECE leadership... the facts that have made it the choice of experts, engineers, universities, and DX fans the world over.

McMURDO SILVER, INC.

3352-G N. Paulina Street Chicago, U. S. A.

McMURDO SILVER, Inc.
3352-G N. Paulina St., Chicago, U. S. A.
Please send me complete description of MASTERPIECE III and details of your FREE TRIAL offer.

Name.....
Street.....
City..... State.....

The OSCILLATOR as a SERVICE TOOL

O. J. Morelock, Jr.

Part Two

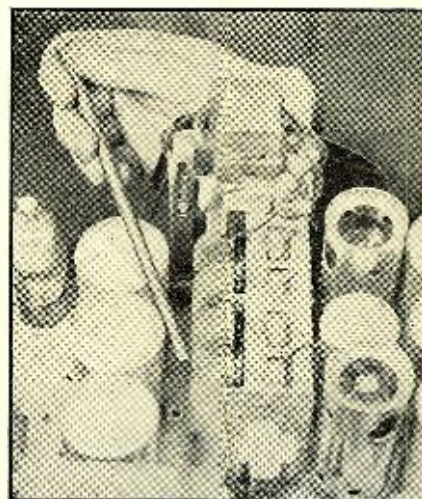

THE alignment procedure in the case of superheterodyne receivers is somewhat more involved than in the case of tuned-radio-frequency sets. The general procedure as outlined in the following paragraphs should be followed as closely as possible to obtain the best results.

The first thing to determine is whether or not the receiver is equipped with automatic volume control, and if so, whether or not it is controlled by a separate tube. If the latter arrangement is used, removal of this tube will simplify the alignment. The operator should be sure however, that the same tube does not perform some other function such as detection or amplification. If automatic volume control is combined with detection or amplification as in the case of the type 55 tube, then the set must be aligned with the automatic volume control functioning.

At the start, the antenna and ground posts of the receiver are short-circuited. In those sets where a separate oscillator tube

is used, the oscillator tube is removed from the receiver. Connections are then made from the service oscillator to the grid of the first detector tube and the chassis. After the output meter has also been connected, the set is turned "on" and the oscillator tuning controls adjusted for the intermediate frequency specified by the manufacturer. The exact control setting for this intermediate frequency is indicated by the calibration curve supplied with the test oscillator. The oscillator is then turned "on" and its output increased until a reading is indicated on the output meter connected to the receiver. Sometimes no indication shows on the meter, even when the oscillator attenuator is turned up all the way. This usually means that the intermediate-frequency transformers are out of alignment. In such a case, the oscillator tuning control should be left at the specified (Cont. on next page)

The Future of Short Waves

(Continued from page 27)

next few years, thus insuring secrecy. Already many of the telephone circuits employ scramblers (speech inverters) which make a telephone conversation non-understandable to outside listeners. This is quite important as most people do not care to talk over a circuit with the ears of the world listening in, even though the federal laws do impose rigid restrictions upon any one listening in on these conversations *not to divulge anything overheard!* Police calls, too, must come to some such sort of system, as this remains one of the greatest barriers to the most effective usefulness of the police networks, although it is not denied that they have accomplished a great amount of good in the apprehension of criminals. Police systems will also employ international circuits that will make it hard for a criminal to find a hiding place anywhere in the world.

Another thing that we undoubtedly have to look forward to is some sort of a system of universal news broadcasting direct from the scene of interest. Events of major news importance will then become available to the whole world simultaneously through a network of criss-crossing international circuits, set up expressly for this purpose, so that within a few minutes of an event transpiring it will be known throughout the world. I am sure public interest will eventually demand such a system, although just how it will be handled or by what parties I will not hazard. We hardly need to peer into the

future to find such a condition, as hardly a day goes by but what we are permitted to listen-in on some unexpected drama of life or politics that has happened on the spur of the moment and that has been brought immediately before the microphone. We all know the excitement of such moments as this! The whole world waited with bated breath during the broadcast of a recent stratosphere flight, as the pilots, falling through space in a doomed balloon, dropping like a plummet, stuck to their guns (or to the microphone in this case) and calmly told what was transpiring even up unto the moment when they were forced to bail out. I also listened to the broadcast, direct from the schooner "Effie Morrissey" through its transmitter W10XDA, which was moored at Hope-dale, Labrador. Captain Bartlett had brought to the microphone a group of Eskimos from the nearby mission school and there, amidst their rude surroundings, they sent out onto the ether a simple program of native folk songs which sent quite a thrill through me. Another broadcast was intercepted from the top of Jungfrau, in the Swiss Alps. The crunching of the feet could be heard in the crisp frozen snow and one could almost breathe the mountain atmosphere as a group of Swiss yodelers sent their songs ringing out with crystal clearness through the rarified atmosphere. Hardly a day goes by but what some new drama of the ether is unfolded and, to me, it is this unexpected and dramatic interest that makes short-wave reception so exhilarating. Although we are not all privileged to "sail the seven seas," we can all be transported, at least for a time, far from the hum-drum realities of our everyday existence by sailing the ether lanes on our present-day short-wave radio receiver.

The Oscillator

(Continued from page 52)

intermediate frequency setting, and adjustments made on the transformers until a signal is noted on the output meter.

Once the signal is obtained with the test oscillator set at the required intermediate frequency setting, the secondary trimmer condenser on the intermediate-frequency transformer directly preceding the second detector should be adjusted to give a peak indication on the output meter. This same procedure should be repeated for each intermediate frequency transformer, working back to the first detector.

If the automatic volume control of the receiver under test operates in conjunction with some other function, as in the case of double-function tubes, the oscillator attenuator should be turned down until a very low volume signal is fed to the receiver during alignment. If the settings far out of alignment, a preliminary trimming of all the intermediate frequency transformers may be necessary to obtain sufficient sensitivity to align with this low volume signal. Only after making sure that this signal remains below the level at which the automatic volume control starts to function, should the final trimming operation be carried out on each intermediate frequency transformer working back to the first detector circuit.

Where the operator is interested in quality of reproduced programs rather than sensitivity, the intermediate frequency transformer should be "flat-topped" for best fidelity. This procedure involves the staggering of the intermediate frequency transformers so that a band width of approximately 5 kilocycles is obtained throughout the i. f. amplifier.

This completes the alignment of the intermediate frequency amplifier, and the operator should next concern himself with the radio frequency and oscillator adjustments. As it is practically impossible to cover exactly radio-frequency and oscillator adjustments on all types of receivers, suggestions from this point on are necessarily of a general nature. Connect the test oscillator directly to the antenna and ground posts of the receiver. Turn on the oscillator and adjust the frequency to approximately 1,400 kilocycles. Remove the short-circuiting clip from the receiver oscillator gang section and tune in the signal on the receiver obtaining a peak reading on the

meter. (The receiver dial should be readjusted at this point, if it has slipped out of calibration on the condenser shaft.) The high-frequency trimmer on the condenser section tuning the mixer circuit should then be adjusted for maximum output, followed by the trimmer for the radio frequency section. Having aligned the radio frequency and mixer trimmers, the next step is adjustment of high-frequency trimmer of the receiving oscillator. All of the above adjustments should be made without changing the position of the gang condenser. These adjustments will suffice to align the gang condenser at the high-frequency end of the broadcast band. For high-frequency adjustment of the short-wave bands, individual trimmers are sometimes used on each coil, these should be left untouched until alignment is made on each of the short-wave bands.

To align the low frequency end of the band, tune the test oscillator to approximately 600 kilocycles and adjust the receiver dial until a peak indication is obtained on the output meter. If the receiver is equipped with low-frequency trimmer condensers, they should be adjusted on the r. f. and mixer sections for maximum output reading. If slotted end plates on the condenser sections are available instead, then the slotted sections of these end plates that are in mesh with the stationary plates should be bent in and out, using an insulated tool for alignment.

The low frequency trimmer or the slotted end plates on the oscillator condenser section should be adjusted while rocking the main condenser control back and forth, noting which adjustment of this trimmer gives a maximum output, irrespective of the receiver dial setting. As this oscillator trimmer practically controls the frequency setting of the entire receiver, the tuning of the main condenser dial will vary with this adjustment.

If there are separate trimmer condensers on the various short-wave coils these can now be re-aligned for the short-wave bands covered. All the adjustments made up to this time on the high and low frequency trimmers and oscillator padders should remain fixed, and all additional adjustments made on these high frequency coil trimmers only.

As the circuits used in short-wave receivers vary widely in design and operation, detailed instructions for aligning these bands are usually supplied by the manufacturer with the receiver. Such instructions should be obtained by the serviceman either from the owner of the receiver or from the manufacturer if a satisfactory job is to be done in all cases.

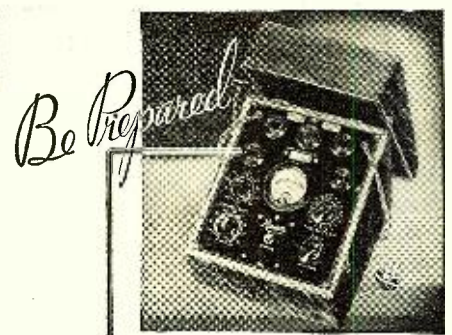

Be Prepared

...To Test The New METAL TUBES!

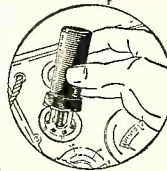

THE tubesituation has changed! Metal tubes are here! Will you be prepared to test the new Octal metal tubes when you

are called upon to do so—or, will you have to tell your customer: "Sorry, Mr. Jones, my equipment is not capable of handling the new tubes."

Be prepared! See the new *Readrite* Model No. 430 Tube Tester . . . at your jobber's. It has been especially designed to handle every type of tube—both with metal or glass envelope . . . accurately and speedily. Constructed with sloping panel and removable cover for either counter or portable use.

The model No. 430 has five sockets, that are flush with the panel. One socket is equipped to test the new 8-Prong Octal metal tube. Another feature of this new tester is the shadow-type line voltage meter . . . located directly above the moving-coil type instrument used for testing Good and Bad tube values. Direct reading. Controls are simple and positive in action. This new all-type tube tester makes every inter-element short and leakage test, which is instantly convincing to the customer.

F. E. Wenger, Radio Engineer of the Readrite Meter Works, says: "The question of servicing the new type Octal metal tube is important to every service man. Readrite tube testers, now in service, can easily be adapted for the new Octal tubes."

Simply get in touch with your jobber, or communicate directly with the Readrite Meter Works for full information of this newest testing equipment.

Readrite Meter Works
160 College Ave., Bluffton, Ohio

RUSH COUPON FOR DETAILS

Readrite Meter Works
160 College Avenue,
Bluffton, Ohio

Gentlemen: Send me literature on your new *Readrite* Tube Tester No. 430.

Name.....

Street.....

City.....State.....

A 5-tube Set

(Continued from page 26)

cycle, 110-volt alternating-current lighting lines.

One of the surprises in testing the set at the listening post was the fact that at this location, which is in the suburbs, it worked better without an aerial than with one. The instructions that go with the set show a number of ways in which it can be used: With a very short antenna of 25 feet or less (using one antenna lead and a ground); with a short antenna alone; with a ground alone; and with certain other combinations. The best way to use the set for short waves as well as the log broadcast band (at the location mentioned) was by connecting the radio antenna lead directly to a ground and with no other connections to the set the receiver pulled in world-wide short-wave reception without a bit of trouble and with only a moderate amount of noise. On the broadcast band, the ability to receive over long distances was limited due to the fact that the tests were made in the summer season when there was no international broadcast-band DX possible. Stations at Chicago, Memphis, Texas, Minneapolis, Kansas City can be mentioned as receivable during the evening hours.

One of the surprises of the set was its high sensitivity on the 16-meter band. Such stations as DJE, PHI, GSG can be mentioned on this frequency as practically locals. After testing on the amateur band (on 20 meters), such amateur transmitters as W1EJK, W2FBB, W3AWP, W4LG, W4AH, W4CJ, W5BDB, W5ZS, W5DDP, W8HHH, W9BJ, W9LD, W9PEO, CO2SE, CO2KC, CO2HY, HI7G, were picked out of our logs as representative amateurs heard more or less regularly. On the 19-meter band the log shows such stations identified as

PCJ, GSF, FYA, W2XE, W8XK; on the 25-meter band—GSD, W8XK, W2XE, DJD, FYA, PHI, CMS (code), HJ4ABA, CJR; on the 31-meter band—HP5J, I2RO, HBP (37 meters), COH, VK3ME, EDZ (code), PRF5, GSC, PZB (code), DJN, W2XAF, CT1AA, EAQ (30 meters), V2KME; on the 49-meter band—W8XAL, YV3RC, W8XK, YV2RC, GSL, XEBT, COC, HJ4ABL. After these tests our operators suggest that the receiver would be an excellent one for Listening Post Observers "on vacation." In other words, here is a surprising little set that will pick up short-wave reception in a suburban or country neighborhood, entirely without an aerial, and this would give the observer a chance to hear short waves during his holiday in the country, without a lot of expense in making an efficient antenna installation. Another use for the set that should be mentioned would be in cities where an aerial of regular dimensions cannot be set up. It will bring in the regular broadcast bands excellently with only a short antenna of 10 to 25 feet, or, by a special connection, without any antenna at all.

Presidential Messages Via Radio

WASHINGTON, D. C.—When President Roosevelt desired the attention of the country, he makes his wishes known to the three great networks, A.B.S., N.E.C., and the Columbia. The President sits at his own desk, the people listen in at their homes. His last 27-minute address was calculated to have been heard by fifty million persons! Between Sept. 3 and Sept. 23, 1919, Woodrow Wilson travelled almost 10,000 miles, making 23 speeches on the League of Nations issue. It was then estimated that 750,000 persons heard him on this speaking tour. Times do change.

Now—a high-powered—

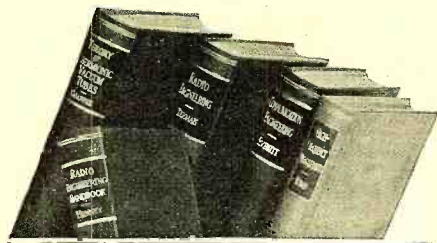

Radio Engineering Library

—especially selected by radio specialists of McGraw-Hill publications

—to give most complete, dependable coverage of facts needed by all whose fields are grounded on radio fundamentals

—available at a special price and terms.

These books cover circuit phenomena, tube theory, networks, measurements, and other subjects—give specialized treatment of all fields of practical design and application. They are books of recognized position in the literature—books you will refer to and be referred to often. If you are practical designer, researcher or engineer in any field based on radio, you want these books for the help they give in hundreds of problems throughout the whole field of radio engineering.

5 volumes, 2981 pages, 2000 illustrations

1. Everitt's COMMUNICATION ENGINEERING
2. Termer's RADIO ENGINEERING
3. Chaffee's THEORY OF THERMIONIC VACUUM TUBES
4. Hund's HIGH-FREQUENCY MEASUREMENTS
5. Henney's RADIO ENGINEERING HANDBOOK

10 days' examination. Special price. Monthly payments. \$26.00 worth of books cost you only \$23.50 under this offer. Add these standard works to your library now; pay small monthly installments, while you use the books.

SEND THIS ON-APPROVAL COUPON

McGraw-Hill Book Co., Inc.
330 W. 42nd St., New York, N. Y.

Send me Radio Engineering Library, 5 vols., for 10 days' examination on approval. In 10 days I will send \$2.50, plus few cents postage, and \$3.00 monthly till \$23.50 is paid, or return books postpaid. (We pay postage on orders accompanied by remittance of first installment.)

Name.....
Address.....
City and State.....
Position.....
Company.....RN 7-35

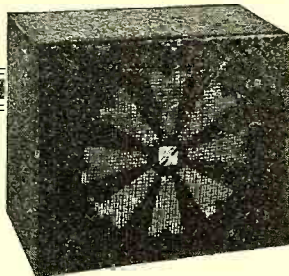

Model 980

for Amateur and Experimenter

New Wright-DeCoster metal cabinet and 8-inch speaker with universal transformer to operate with all output tubes . . . \$9.80 list.

Model 1000-B for Browning 35 sets, \$10.00 list.

Model 1000-A-S for All Star Sr. & Jr. Sets, \$10.00 list.

DeLuxe wood cabinets slightly higher.

Write for dealer's discount, catalog and name of nearest distributor.

Our distributors are anxious to cooperate with you.

WRIGHT-DECOSTER, Inc., 2255 University Ave., St. Paul, Minn.

RADIO SERVICING

Residence course, 6 months, modern methods, new courses, special work on service equipment and superheterodyne servicing; instruction on public address systems, photo cell and cathode ray tubes included. Other courses obtainable: Radio Engineering—9 months; Marine Radio—6 months; Morse telegraphy—6 months. School est. 1874; All expenses low. Catalog free.

DODGE'S INSTITUTE, Eleventh St., Valparaiso, Ind.

The DX Corner for Short Waves

(Continued from page 21)

YNBA, Managua, Nicaragua, 48 meters, reported on the air 7-10 p.m., E.S. (Villar.)

HRP1, San Pedro sula, Costa Rica, is soon to be on the air on a new wavelength of 49 meters. (Manuel Escoto, owner.)

HH2R, Port-au-Prince, Haiti, reported testing on approximately 9560 kc., 10:50-11:20 p.m., E.S.T. (Duncan.)

CMJQ, a Cuban station reported on the short waves by Alan Smith, 7 p.m., E.S.T. Who knows wavelength and other data?

PIIJ, Dordrecht, Holland, now transmitting on 42.35 meters, 7082 kc., from 16:10 to 17:10, G.M.T. (Norman Smith.)

LKJ1, reported now transmitting on about 42 meters. (Friedl.)

DIQ has been heard rebroadcasting German programs on 10285 kc. (Chambers, Westchester.)

DJR, Zeesen, Germany, 19.56 meters, 15340 kc., reported heard 8-11 a.m., E.S.T. (Waters Eisler.)

CMHB, Sanctus Spiritus, Cuba, is the long-wave call of a station that has been testing on 10.2 and 10.4 megacycles, on 24.4 meters and 29.73 meters, according to reports, from 3:30 to 10:30 p.m., E.S.T. (Kentzel, Winand, H. T. N., J. H. Miller, Chambers, Twomey, Lee Davis, Gallagher, Alan Smith Bower, Hall, Myers, Hamilton.)

CO5RY, Matanzas, Cuba, reported testing on about 7150 kc. after 10 p.m., E.S.T. (Peters.)

CO9GC, Santiago de Cuba, 48.78 meters, 6150 kc., reported on the air 8:30-10 a.m., 12 a.m.-1 p.m., 3:30-4:30

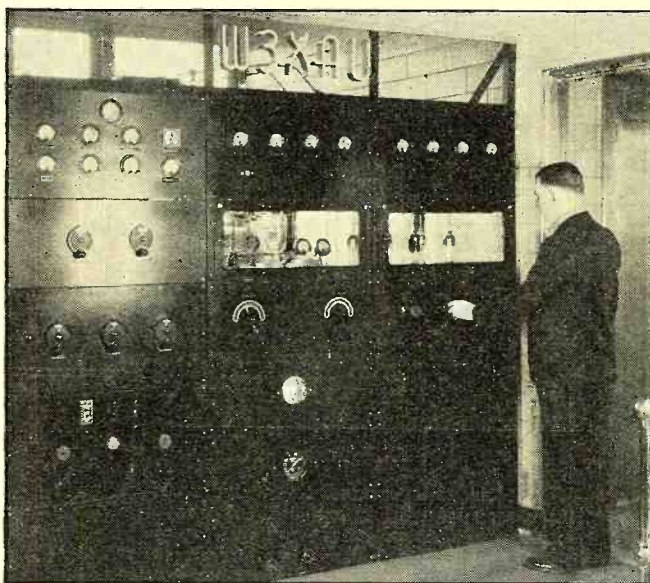

SHORT WAVE RADIO STATION W3XAU, PHILADELPHIA, PA.

GSL, Daventry, England, experimental tests on 49.1 meters on Sundays, Mondays, Wednesdays and Fridays around 10-11 p.m. (Harris, Jensen, Amlie, Walker.)

HAS3, Budapest, Hungary, announces as simply HAS, according to Schradiek and Sholin.

HAT4, Budapest, Hungary, announcing as HAT, is now transmitting on 32.88 meters on Sundays, 6-7 p.m., E.S.T. Baadsgaard, Donaldson, Sholin, J. H. Miller, Alan Smith.) The short-wave outlet on 31 meters has been changed from 31.4+ meters, 9540 kc., to 31.54 meters, 9572 kc., to avoid interference with DJN. (Westchester.)

HCJB, Quito, Ecuador, reported heard on 36.5 meters, 8-11 p.m., E.S.T.

HJOP, Guayaquil Ecuador, reported heard on 64 meters, 10 p.m.-12 m., E.S.T. (Villar.)

Who has heard Pearl Harbor, Honolulu, Hawaii, broadcasting on a wavelength of about 18 meters? What are its call letters? (Aarns.) Is this the promised short-wave outlet of KGU? It is reported KGU has filed application to operate as a broadcaster on 17780 kc. and also on 9570 kc. (Kalmbach, Sholin.)

DJD has shifted frequency from 11760 kc. to 11770 kc. to avoid conflicting with GSD. (Schradiek.)

p.m., 10-11 pm. and on Mondays from 1-3 a.m., E.S.T. (Villar, Akins, Musser.)

CT1AA reported still testing on 50.17 meters and on 25 meters. (Rosa, Houghton.)

VP6YB, Barbados, BWI, reports they are now only on a 20-meter band on 14312 kc., and may be heard from 3-5:30 p.m. with amateur programs. (Archer, owner.)

KEE, Bolinas, California, 38.85 meters, 7715 kc., reported heard 10-12 p.m., E.S.T., rebroadcasting American programs. (Amlie, Pilgrim, Eisler, Deming, Lussier, Swartley, Reed, Wolpe, Jr., Schumacher.)

KEJ, Bolinas, California, reported heard on 9010 kc., rebroadcasting American programs. (Pilgrim, Wolpe, Jr., Lyell, Wedel, Reed, Wojkeiwic.)

Calls and frequencies of Bolinas, California, commercial stations: KEB, 7370 kc.; KEE, 7715 kc.; KEJ, 9010 kc.; KEL, 6860 kc.; KES, 10410 kc.; KEZ, 10400 kc.; KKQ, 11950 kc.; KKW, 13780 kc.; KQJ, 1802 kc. (R. E. Mangum.)

Calls and frequencies of Rocky Point, New York, commercial stations: WAD, 8930 kc.; WAJ, 13480 kc.; WBU, 21260 kc.; WCG, 10370 kc.; WDA, 9480 kc.; WDB, 6718 kc.; WDN, 4550 kc.; WDS, 18900 kc.;

WEA, 10610 kc.; WEB, 6935 kc.; WEC, 8930 kc.; WED, 10630 kc.; WEF, 9490 kc.; WEG, 7415 kc.; WEJ, 6740 kc.; WEL, 8950 kc.; WEM, 7400 kc.; WEO, 6958 kc.; WES, 9448 kc.; WET, 9470 kc.; WEX, 13540 kc.; WEZ, 6928 kc.; WFX, 18980 kc.; WHR, 13420 kc.; WIR, 4276 kc.; WIY, 13870 kc.; WJN, 13370-7370 kc.; WKC, 10465 kc.; WKD, 13435 kc.; WKL, 8940 kc.; WKM, 18860 kc. (R. E. Mangum.)

Readers Who Are Awarded "Honorable Mention" for Their Work in Connection with This Month's Short-Wave Report

Russell W. Foss, P. R. Hunter, L. E. Balcom, Ray A. Walters, Roy L. Christoph, Louis A. Amstutz, John Wojtkiewicz, A. H. Rousseau, M. Keith Libby, D. S. Catchim, Richard Suratt Jr., A. B. Baadsgaard, Clarence D. Hall, Phil B. Laeser, Oliver Amlie, R. S. Houghton, Myles Swartley, C. V. Hunter, Larry Eisler, Edgar J. Vassallo, Joseph H. Miller, Kenneth Dressler, Henry W. Bivins, Alfred Quaglinio, William D. Owens, Evert Anderson, Vincent M. Wood, R. C. Messer, J. Herbert Hyde, Jose Perez, L. T. Lee Jr., Fred A. Pilgrim, George C. Akins, Billy O'Brien, James E. Moore Jr., Robert J. McMahon, Irving M. Noether, Phillip R. Belt, R. B. Holmgren, W. W. Gaunt Jr., Raymond C. Bussey, Forrest W. Dodge, Morgan Foshay, Earl R. Wickham, Harry E. Kentzel, Howard T. Neupert, Dwight E. Getz, Carl P. Peters, Edward DeLaet, Orval Dickes, W. H. Boatman, Nick Sinco, Charles B. Marshall Jr., Eugene T. Musser, Gaines Hughes Jr., W. O. Deem, Aubrey H. Forbes, A. Belanger, Edela Rosa, Rene Arickx, Claude Dulmage, Douglas Thwaites, J. Rowson, A. J. Webb, B. Scheirman, Mike Kruger, Norman Nattall, Arthur Whitehair, R. W. Winfree, David Geiser, R. W. Evans, Arthur B. Coover, G. L. Harris, Arthur Lussier, Vaughn P. Drake Jr., F. T. Reilly, E. L. Myers, M. Kelly Powers, Arthur Leutenberg, Dr. E. Villar, Stan Elchehen, Howard Singer, James G. Moore, Clifford Pryor, C. E. Gates, A. C. Doty Jr., Joseph F. Olson Jr., Robert Edkins, Thomas P. Jordan, R. H. Pulver, Howard Adams Jr., D. R. D. Wadia, Andrew Covington, R. E. Mangum, O. Ingmar Oleson, Ibbie Smith, Danford Adams, A. C. Lyell, Roy Sanders, Alfred D. Seals, Howard A. Olson, Paul Byrns, H. S. Bradley, August J. Walker, F. W. Gunn, William Schumacher, Donald W. Shields, Hagop Kouyoumdjian, Robert Irving, P. B. Reed, Arthur Hamilton, John C. Kalmbach Jr., J. L. Atkinson, Thursten Clarke, Charles W. Krier, L. M. Jensen, Werner Howald, Overton Wilson, J. F. Edbrooke, G. W. Twomey, Ralph B. Baldwin, William Koehnlein, Walter W. Winand, Leon D. Tallman, John E. Moore, Robert Edkins, Harry Currier Jr. Lloyd Waters, Sydney G. Milleu, Manuel E. Betances, A. C. Bushnell, Norman C. Smith, Howard Morse, William J. Vette, Baron von Huene, H. Dobrovoly, Dr. Hausdorff, J. Harold Lindblom, Dwight Williamson, Albert E. Emerson, Harold W. Bower, Dr. Alan E. Smith, Walter F. Johnson, G. C. Gallagher, James L. Davis, Robert Loring Young, Ferry Friedl, George C. Sholin, Charles Dooley, Duncan T. Donaldson, Walter L. Chambers, Manuel Ortiz Gomez, Kenneth H. Moffatt, Carl Schradieck, Albert Bond, Hanik G. Wedel, Ivanhoe Fortin, A. S. Daws, James E. Romlett, I. F. Wolpe Jr., Alberto Palacio, J. V. Duncan, Virgil Scott, Leon Stabler, L. C. Healey, Jerry H. Duncan, Bernard Kent, Carl Scherz, George Munz, James F. Maguire, J. Ira Young, Robert A. Hallett, Jerry M. Hynek, Emerson Cobb, Harold H. Flick, J. E. Brooks, Anton T. Aarns, B. L. Cummins, Albert Griffin, Wooster Richard, Norman N. Puhaly.

Midget Receiver

(Continued from page 13)

- Two Eby 6-prong sockets
- One Eby 5-prong socket
- One Jensen 5-inch dynamic reproducer with output transformer designed for the 38A tube, field resistance of speaker 3500 ohms
- One Insuline electrical alloy chassis 8¼ inches by 4½ inches by 1½ inches high
- One Crowe tuning unit with escutcheon
- One Crowe plate for volume control
- Two Kurz Kasch knobs, one for R and one for C
- One Eby 7-prong plug with 8 feet of 4-wire cable
- One antenna reel 25 feet long
- One cabinet

On ¾ Meters

(Continued from page 31)

is quite useless. Like trousers, you must have a pair to be able to use them! The construction and outdoor field testing of a pair of 75 cm. transceivers would certainly be an excellent summer program for a radio club.

As to the range to be expected—car to car in a residential section, ¼ to ½ mile; rural section, ½ to 1 mile; house to car, perhaps 2 to 5 miles, depending on location, height and conditions along the path of transmission. A series of tests are being run at Jones Beach State Park, Wantagh, L. I., by the author with the hearty co-operation of Bill Volkammer, W2HO, and other members of the Nassau Radio Club of Oceanside, L. I. One 75 cm. station is located 160 feet above ground and the other in a car. In the first test, voice communication was carried on up to a distance of 12 miles with 100% intelligibility up to about 10 miles. The complete series of tests will be described later—probably next month.

Seventy-five cm. work is very convenient for beginners in the amateur game. Of course, a license is required as with any type transmitter. There is no interference of any kind, barring some car ignition and manmade interference, but these are much less bothersome at this wavelength than at 5 meters. It really amounts to a clear channel on the air. It is ideal for code practice or private chats. And there are no worries about being off frequency—for the present, at least.

List of Parts

- C1—Aerovox mica condenser, type 1468, .0001 mfd.
- C2—Cardwell "Trim Air" midget condenser, type RT-15
- C3—Aerovox mica condenser, type 1468, .0005 mfd.
- C4—Aerovox electrolytic condenser, type PR25, 10 mid., 25-volt
- J1, J2—Yaxley junior jacks, type 701
- R1—Lynch resistor, 15,000 ohms, ½ watt
- R2, R3—Lynch resistors, ¼ megohm, ½ watt
- R4—Lynch resistor, 600 ohms, ½ watt
- SW1—Yaxley midget jack switch, type 10
- SW2—Yaxley 6-pole, 2-throw gang switch, type 1335, 3-deck
- T1—National combination microphone and plate-to-grid transformer, type TR-1
- T2—Thordarson pentode plate to 2000- and 10-ohm output transformer, T-6806
- 1 National receiver case
- 1 National "Velvet Vernier" dial, type BM
- 1 Communications Eng. Co. micalex socket for 955
- 1 National 6-prong Isolantite or equal tight-grip socket
- 1 Jones 4-prong plate plug
- 1 Jones 4-contact cord socket
- 1 4-wire battery cable for outside use
- 6 Birnbach smallest porcelain lead-in insulators
- 2 Birnbach Micro-Mite porcelain stand-off insulators
- 1 0-10 ma. d.c. meter for setting up (optional)
- 10 feet No. 10 or 12 solid antenna wire, or brass rod
- ¼ oz. No. 33 d.s.c. or s.e. wire for r.f. chokes
- ¼ inch bakelite shaft with 6-32 screw pinned in one end to serve as extension shaft for Cardwell condenser 2 inches in length
- 3 inches bakelite rod to serve as mounting bushings for Cardwell condenser, ends drilled and tapped for No. 4 screw



Does news like this

render your equipment obsolete? — NOT IF YOU USE WESTON EQUIPMENT

Servicemen who use the Weston method of *Selective Analysis smile when these new developments are announced. They don't have to dig into their jeans to buy new instruments, for tube changes have no effect on the serviceability of the Weston Selective Analyzer. A new tube base simply means a small, inexpensive unit for the socket selector. The analyzer itself serves for all present and all future tubes.

Like all Weston instruments for radio servicing, the Weston Selective Analyzer was designed with an eye to the future . . . with full regard for all problems of the serviceman. That's why Weston users today have no worries over analyzer obsolescence, or instrument dependability. That's why far-sighted servicemen insist on Weston Selective Analyzers, and other Weston instruments, for all servicing needs . . . Weston Electrical Instrument Corporation, 615 Frelinghuysen Ave., Newark, New Jersey.

The *Selective Method of Analysis is a Weston contribution . . . and is now available in three analyzer models, in price ranges to suit any pocketbook.



NEW - EXCLUSIVE SENSATIONAL

Accept...FREE FIVE DAY TRIAL OFFER



TOLEDO'S new speaker assembly with all aluminum baffle housing and adjustable wall mounting bracket

meets every indoor requirement of appearance, adaptability and performance. Improved baffle design greatly increases speaker efficiency and greatly reduces feed-back possibilities. Write for descriptive data on the TOLEDO line of laboratory built sound equipment. Get our prices and let us explain our liberal FREE FIVE DAY TRIAL offer!

- Portable Sound Systems • Electro-Dynamic Units • Carbon Microphones • Amplifiers • 4, 5 and 6 Ft. All Aluminum Natural-tone Trumpets • Field Exciters • Air Column Horns • Low and High Frequency Units For Wide Range Theatre Use

TOLEDO SOUND EQUIPMENT LABORATORIES
Formerly Bud Speaker Co.
1138 JACKSON STREET • TOLEDO, OHIO, U. S. A.

Have You UP-TO-DATE Technical Data on RADIO TUBES?

The new Seventh Edition Characteristic Chart provides this valuable information in handy ready reference form. Fill out the coupon below for a free copy.

RAYTHEON PRODUCTION CORP.,
Dept. D7, 30 E. 42nd St., New York, N. Y.
Please send 1935 Tube Chart

Name _____
Address _____
City _____

RAYTHEON
4-PILLAR RADIO TUBES

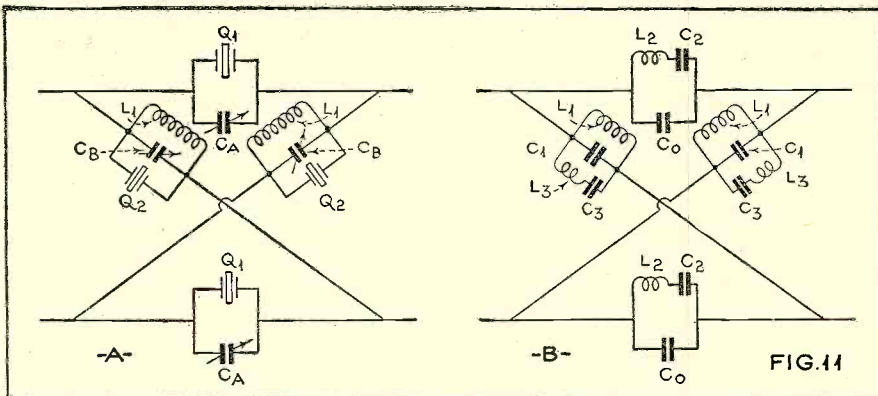

THE DESIGN OF BROAD-BAND CRYSTAL FILTERS

W. W. Waltz

Part Two

THIS is the second of this important series of articles on a new and practical application of quartz crystals in high quality radio circuits. The first article appeared in the June, 1935, issue.

It is the custom, when discussing filters, to consider first the high-pass and the low-pass types, these being the most simple sections. At first glance, it might seem possible to form the more complicated band-pass and band elimination filters simply by a series or parallel combination of low and high-pass sections. This, however, is not the case; combining sections in this manner would result in serious impedance irregularities.

In effect, a low-pass filter employing crystals is of the band-pass type in which the lower cut-off frequency has been relegated to zero; in the high-pass sections, it is the upper cut-off frequency (of the band pass section), which is shifted, in this case, to infinite frequency.

The structure of Figure 11(A) is a low-pass section having a characteristic curve as shown in Figure 12. In accordance with Figure 3 the crystals shown in Figure 11(A) can be replaced by the crystal equivalent circuit, resulting in the network of Figure 11(B). The values of the different coils and condensers of Figure 11(B) are obtained from the following formulas:

$$L_1 = \frac{Z_o B}{2\pi f_c D} \tag{7}$$

$$L_2 = \frac{Z_o (A + D)^2}{2\pi f_c (AB - D)} \tag{8}$$

$$L_3 = \frac{Z_o (1 + B)^2 B}{2\pi f_c (AB - D)} \tag{9}$$

$$C_o = \frac{1 + B}{2\pi f_c Z_o (A + D)} \tag{10}$$

$$C_1 = \frac{A + D}{2\pi f_c Z_o (1 + B)} \tag{11}$$

$$C_2 = \frac{AB - D}{2\pi f_c Z_o (A + D) D} \tag{12}$$

$$C_3 = \frac{AB - D}{2\pi f_c Z_o (1 + B) B^2} \tag{13}$$

In the above

$$A = a_1 + a_2 + a_3$$

$$B = a_1 a_2 + a_2 a_3 + a_3 a_1$$

$$D = a_1 a_2 a_3$$

The determination of a_1 , a_2 and a_3 is made from the relationship of various res-

onant and anti-resonant frequencies to f_c , the cut-off frequency, and is given by

$$a_n = \sqrt{\frac{f_n^2}{f_c^2 - f_n^2}} \tag{14}$$

$n = 1, 2, 3$ (f_1, f_2 and f_3 of Figure 12)

These peak frequencies (f_1, f_2 and f_3), which depend upon the elements associated with the crystal and are, consequently, under the control of the designer, may be given such values that the design cannot be physically realized by means of crystals because values of C_o and C_1 are less than 125 times those of C_2 and C_3 .

In order to avoid the complicated calculations of a filter network which might later prove to be unrealizable, the ratio below can be determined initially:

$$\frac{C_o}{C_2} = \frac{(1 + B) D}{AB - D} \tag{15}$$

$$\frac{C_1}{C_3} = \frac{(A + D) B^2}{AB - D} \tag{16}$$

If these ratios are equal to or greater than 125 the section is realizable. In general, placing the peak frequency close to the cut-off frequency (within two per cent) will insure acceptable values for these ratios.

Having determined the values of the coils and condensers in the equivalent circuit of the filter

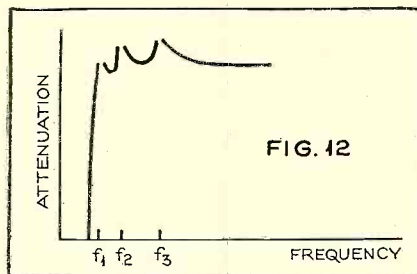

section, the dimensions, in centimeters, of the correct size of crystal are determined from equations (1), (2) and (3) given earlier in this article. It will immediately come to mind that substitution in these equations will result in expressions having three unknowns, i.e., the length, width, and thickness of the crystal. This difficulty is avoided by arbitrarily selecting one of these dimensions and solving for the other two. Since crystals used for filter purposes usually vibrate on the long dimension, the arbitrarily chosen dimension can very well be the thickness. Or, the three equations may be solved simultaneously, by the customary algebraic methods, for the three unknowns.

High-pass filters are of little, if any, interest to the radio engineer and will not be discussed here. Those interested are referred to the appended bibliography.

Bibliography

1. CAMPBELL, G. A. "Physical Theory of the

- Electric Wave Filter," *Bell System Technical Journal*, Vol. I, No. 2, pp. 1-32. November, 1922.
- JOHNSON, K. S. *Transmission Circuits for Telephonic Communication*. New York, D. Van Nostrand Co., 1927.
 - LACK, F. R. "Observations on Modes of Vibration and Temperature Coefficients of Quartz Crystal Plates," *Bell System Technical Journal*, Vol. VIII, No. 3, pp. 515-535. July, 1929.
 - LACK, F. R. *loc cit.*
 - WORTHEN, C. E. "Piezo-Electric Quartz Plates," *The General Radio Experimenter*, Vol. IV, No. 9, pp. 1-8. February, 1930.
 - VAN DYKE, K. S. "The Piezo-Electric Resonator," *Proc. I. R. E.*, Vol. XVI, No. 6, pp. 742-764. June, 1928.
 - MASON, W. P. U. S. Patent No. 1,921,035, August 8, 1933.

Education in Radio

(Continued from page 33)

who cannot spare two whole years from the serious business of making a living, there are several 9-month residence courses in radio engineering, which, with a bit of supplementary study on his part, should make a sound and excellent engineer of him. The entrance requirements for these courses are elastic, and no engineering degrees are conferred. Such a course is featured at the Dodge Institute, Valparaiso, Ind., classes being organized four times a year. Additional study of physics and higher mathematics is recommended to the serious student. The sum of \$500 should carry the prospective engineer comfortably through the course—tuition and living expenses.

The course at the Bliss Electrical School, Washington, D. C., while primarily designed to develop an electrical technician, provides an excellent background for radio work. Electronics and radio theory are studied in the latter part of the term. A graduate from the Bliss School has the advantage of being trained for a variety of electrical jobs—a consideration of serious import in these days of economic re-organization. A degree of M. El.—Master of Electricity—is conferred upon the completion of one year's practical work in the field. Again the course should be supplemented by the study of math, physics and general science.

The Capitol Radio Engineering Institute, also in Washington, offers a 9-months residence course—specializing in radio engineering. Math. training is carried up to and including the calculus, leaving only physics for supplementary study. Living and tuition costs for both of these Washington schools will approximate \$1,000.00. Registration is in September only, with graduation in June.

A 9-months' course similar in scope to the C. R. E. I. residence training is offered by the extension division of the University of Wisconsin at Milwaukee.

To those living within convenient distance of New York City, there are numerous night classes in the technical institutes and colleges where the desired sort of training may be assimilated. New York University and the Columbia University Extension both offer several courses in electrical engineering, radio communication, physics, chemistry, general science and mathematics, with credits that may lead ultimately to the coveted degree. In all instances of such residence courses, primary instruction is available to satisfy the entrance requirements for the more advanced courses.

The ambitious student can obtain an engineering education from any one of the correspondence schools, plus a bit of supplementary work on the outside. All these courses—I. C. S., C. R. E. I., R. T. I., N. R. I.—are engineering in nature, but give less consideration to science as a background. The National Radio Institute and C. R. E. I., go a bit further than the others with mathematics. No degrees, of course, are conferred.

The wholly self-trained engineer is a possibility and an actuality. The writer knows of several men, who have never enjoyed any other than self-training since their public-school days and who are holding down responsible engineering jobs. As in the service and operating fields, successful training of this sort is limited to those students who are psychologically fitted to teach themselves. They are not many!

The man employed in an engineering or experimental laboratory—preferably with some radio manufacturer—has the best chance of progressing through correspondence or self-training. He benefits by association with engineers, he assists them in their research, acquires a familiarity with equipment and he has always before him the immediate possibilities of advancement. The actual mechanics of self-training is pretty much a matter of studying adequate texts. The student should continually read the leading technical magazines and journals, affiliate himself with the Institute of Radio Engineers and attend technical meetings religiously.

The student who places the greater burden of his education on correspondence or self-training, should expend every effort to find the time and

money for one of the shorter residence courses during the first two years of his training period. Such supplementary training is nothing short of essential in solidifying his knowledge and establishing contacts which will be invaluable to him in ultimately securing the type of employment he wishes. The following institutions give excellent courses of this nature, and a choice will be largely a matter of geographical preference—The Radio College of Canada, Toronto; National Radio and Electrical School, Los Angeles, Calif.; First National Television, Inc., Kansas City, Mo.; The Coyne School, Chicago, Ill.; R. C. A. Institutes, New York City; Port Arthur College, Port Arthur, Texas, and the Tyler Commercial College, Tyler, Texas.

There are many excellent texts for study in self-training. In mentioning the few below, other good books are necessarily neglected and it is hoped that the student will not confine himself to the texts we recommend. The writer would suggest starting with Ghirardi's *Radio Physics*, to be studied simultaneously with Henney's *Principles of Radio*. Following these books, the student should tackle such texts as *Radio Engineering Principles* by Lauer and Brown, Morecroft's *Principles of Radio Communications*, Terman's *Radio Engineering*, *Thermionic Vacuum Tube Circuits* by Peters, *Thermionic Vacuum Tube* by Van Der Bilg, *Principles of Electricity* by Page, and *Alternating Current Phenomena* by Steinmetz.

These categorical texts should be supplemented by the simultaneous study of mathematics and general science. As we have made repeated mention of such supplementary work, it will be well to give it detailed consideration here.

The desired mathematical training can best be secured at an adequate residence school. The R. C. A. Institutes, School of Communication Engineering, has recently announced courses in mathematics, considered from a communication as well as a general point of view, carrying the student from arithmetic through operational calculus.

Home study is next in favor as a means of acquiring the supplementary education. Self-training is the third, and quite feasible method of getting a hold on the necessary general science and math. Any standard high-school textbook on physics should be carefully studied, and followed with good college physics texts.

It may take you several years to work through all of this—but you'll find it worth while. In conclusion we quote from a pamphlet published by the Engineering Foundation—"Although a school or teachers may help you greatly, no school can make of you a successful engineer or a fine man, or prevent you from becoming one. That is up to you."

Learn Radio

(Continued from page 5)

building. These are those persons, young and old, responding to the lure of short-wave radio reception. They are streaming into the ranks of radio enthusiasts in great numbers and are finding that listening to distant stations from all over the world on a set they built brings a thrill not gotten from any other sport. In correspondence with many thousands of these short-wave fans, our Editor finds that even the old-timers are still interested in set building, making the leading models as they are described in spite of the fact that they also own as many as three or four modern commercial-built receivers. RADIO NEWS has always led in this field, in bringing to our readers the best of the crop of new designs of receivers for all purposes as well as testing instruments for tubes, sets, resistances, inductances and capacities. It will pay any reader to follow these descriptions, from month to month and from year to year, simply for the educational feature of keeping up-to-date with the new developments they contain. This is one of the reasons why the RADIO NEWS reader is always of a higher grade and more fully informed than the "next fellow." True to tradition, this issue of RADIO NEWS gives important data on a number of new developments that can be built by the radio-man in a few hours spare time. Look through the magazine's pages and find the development that interests you most and get out the old tools and get busy! You will find it will revive your interest and prove worth-while no matter what your status is in radio today.

Make More Profits Give Better Service



with the new
ELECTRONIC
Auto Radio
Vibrator Tester

With no more trouble than testing a tube, it indicates accurately, quickly, and in plain English whether vibrator performance is good or bad and when replacement is necessary. Tests all makes and types. Frequency indicator lamp shows when vibrator is causing undue RF interference. Operates from 6 volt storage battery. Attractively metal cased. Size 12"x15". Comprehensive replacement chart and complete directions included. Special price to dealers and service men. Send for engineering details.

ONLY 18 TYPES of ELECTRONIC VIBRATORS Service All Sets

Electronic vibrators have many exclusive features which make them the best money can buy—bar none. Assures better than new service unless the set was originally Electronic equipped! No large stock required to service all sets. Reasonably priced and amply margined.

Send for FREE monthly REPLACEMENT GUIDE covering all makes. Also details for securing a FREE MERCHANDISER

ELECTRONIC LABORATORIES, INC.
World's Largest Exclusive Manufacturers of
Vibrators and Power Supplies
120 West New York St.
Indianapolis, Ind.



INCREASE YOUR LOG!
NOISE WON'T BOTHER YOU in your S.W. Listening Post if you own a Browning 35 for this amazing all-wave receiver is exceptionally sensitive to signals to which it is tuned but at the same time it is able to disregard utterly any interference and static on adjacent channels. The Listening Post Observer who appreciates the importance of high signal to noise ratio will find the Browning 35 with the TOBE Super-Tuner a positive revelation!
No wonder it has been hailed and acclaimed editorially by *Radio News*, *Short Wave Craft*, *Radio*, *N. Y. Sun*, *Radio Index* and many others! Words fail to describe the quiet operation, the extreme sensitivity and the amazing ability of this receiver to aid you in identifying new stations and getting their calls.
Your favorite jobber can supply you—if not, write direct to us for:

FREE: illustrated tabloid complete with circuit diagrams, parts list, full details and discounts.

TOBE DEUTSCHMANN CORP.
Dept. G-10 Canton, Massachusetts
Export Dept.: 105 Hudson St., New York





Put More Stations

ON YOUR DIAL

with the RCA World-Wide Antenna

Your radio will give amazingly better performance with an RCA World-Wide Antenna!

It greatly reduces all man-made interference on short waves and brings you more foreign stations. \$6 plus installation.

The De Luxe RCA World-Wide Antenna reduces man-made interference on all wavelengths. \$7.50 plus installation.

Ask your radio service engineer or dealer for a *Certified* Installation of the Noise-Reducing RCA World-Wide Antenna. And write for booklet, "Antenna Facts".

RCA PARTS DIVISION



Dept. N CAMDEN, N. J.

WORLD-WIDE ANTENNA SYSTEM

Public Address

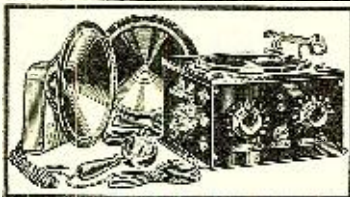

20 WATT MOBILE SOUND SYSTEM

A complete P. A. System for use in sound trucks or cars, or where A.C. is not available. Operates entirely from a 6 Volt storage battery. Consists of 20 watt amplifier, dynamotor, 6 Volt 2-speed phonograph motor and pickup entirely contained in steel cabinet. Includes two giant dynamic speakers, hand microphone, cords and polarized plugs. Has built-in "mixer" control. Complete, compact, simple to install and operate. Write for details.

ALLIED RADIO CORPORATION, 833 W. Jackson Blvd., Chicago, Dept. M.

Send me complete information on the following:
 20 Watt Mobile System
 Name.....
 Address.....

ALLIED RADIO

TESTING The New METAL TUBES

OWN the new "Dependable" Model 305 Tube Tester, and you'll be ready for all-comers—today's tubes and future types—without straining your pocketbook.

Many new exclusive features of special value to service men—
 Write Dept. RN-7 for Complete Data.

RADIO CITY PRODUCTS CO. 28-30 W. Broadway, N. Y.

Perpetual Tube Checker

(Continued from page 34)

use of existing equipment, and the transformers will not be uniform always, especially if purchased from different manufacturers. It is so simple to compile one's own table from tubes of known quality that it is unnecessary to give data here.

It is well to note in closing that where tube indications go off scale on the 50 ma. setting, as with the 866 tube and other mercury-vapor types, it is only necessary to partially depress G, which act places the 1000-ohm biasing resistor in the load and drops the reading within the scale. Another means is to use a lower filament voltage than that rated. If the data are based on this lower voltage, the reading will, with few exceptions, give the relative condition of the tube quite as well.

This tester will take care of the new tubes, 12A5, 6Z5 and 12Z5, but the connections to socket terminals 3 and 4 must then be as shown, terminal 4 connecting to the B— bus.

Table of Co-ordinate Switching

Test Number	1st Setting	2nd Setting	3rd Setting
1	13-21
2	11	21	...
3	21
4 and 4A	11-21-C3
5	12-21	51-62	...
6	13-21-51
7	13-21	21-53	...
8	13-21-52
9 and 9A	11-21-52-C3
11	11-21-52-63-C3
13	21-52-C3	11-52	61-52
14	13-21-52-61	21-52-61-C3	...
15 & 15A	11-21-52-63
16	C1
18 Pent.	11-21-52-62-73	13-21-52-63-73	...
19	13-21-62	Triode 51-62-C3	...
20 Pent.	11-21-52-C3	52-63-71	...
21	11-21-52-C3	Triode 61-52	71-52
22	21-12
23	21-52	11-52	...
24	13-21-72	51-63-72	...
25	13-21	51-63	...
26 Pent.	21-51-C3	11-63	...
27 Pent.	11-21-52-C3	Triode 52-63-71	...
28	11-21-62-73	Triode	...
29	11-21-62	22-51-62	...

Table of Tube Settings

Type Number	Test Number	Fil. Volts
1A6	26	2
2A3	1	2.5
2A5	15A	2.5
2A6	13	2.5
2A7	20	2.5
2B7	21	2.5
6A4	6	6.3
LA	6	6.3
6A7	20	6.3
6B7	21	6.3
6F7	27	6.3
12A5	28	6.3
200A	1	12.6
01A	1	5
10	1	7.5
WX-12	1	7.5
112A	1	1.1
19	25	2
120	1	3.3
22	4	3.3
24	9	2.5
26	1	1.5
27	8	2.5
30	1	2
31	1	2
32	4	2
33	6	2
34	4A	2
35	9	2.5
36	9	6.3
37	8	6.3
38	9A	6.3
39-44	9A	6.3
240	1	5
41	15A	6.3
42	15A	6.3
43	15A	25.
45	1	2.5
46	7	2.5
47	6	2.5
48	15	30.
49	7	2.
250	1	7.5
53	21	2.5

Type Number	Test Number	Fil. Volts
55	13	2.5
56	8	2.5
57	11	2.5
58	11	2.5
59	18	2.5
71A	1	5
75	13	6.3
77	11	6.3
78	11	6.3
79	19	6.3
85	13	6.3
89	14	6.3
199	1	3.3
864	1	1.1

Rectifiers

5Z3	2	5
12Z3	22	12.6
12Z5	29	6.3
25Z5	5	25
1-v	22	6.3
80	3	5
281	3	7.5
82	2	2.5
83	2	5
84	23	6.3
6Z4	23	6.3
6Z5	29	6.3
866	16	2.5

Directions

Obtain "Test Number" from "Table of Tube Settings." Refer to "Table of Coordinate Switching" with this number to find coordinates of the tube test. Record the plate current readings with negative bias, zero bias, and plus bias. Transfer all data so obtained to the manufacturers table of tube characteristics to save time in future references.

All-Purpose Tester

(Continued from page 36)

to the proper functioning of a tube but that a leakage resistance above 100,000 ohms may be permissible. Therefore, it is advisable to so design the tester that it will indicate leakages below about 100,000 ohms and not indicate leakages much beyond this value. This dividing line is not critical, and it is probable that a value of 200,000 ohms could just as well be chosen for the leakage limits. Theoretically speaking, all tubes have some leakage through the insulation of almost infinite resistance values between the tube elements, and it is probable that some new tubes may have insulation resistance as low as two or three megohms, but be entirely satisfactory for radio operation, so we would not want the tester to suggest that those tubes are unsatisfactory, by indicating such leakage values above 100,000 or 200,000 ohms.

It was shown in the first part of this discussion that the analytical functions of this tester, based on the well-known "Free Reference Point System of Analysis," is remarkably applicable to the test requirements of the new 8-pin "metal tubes," and it is now interesting to observe that the tube testing functions of the tester are also applicable to these new tubes, without affecting, in the least, the simple 3-step testing procedure which has characterized Supreme's tube tester developments of the past. A tube, old-style or new-style, cannot be placed in the wrong tube testing socket, nothing happens if the wrong button is depressed, and the tester cannot be harmed by an incorrect selector setting or by a "shorted" tube; the leakage test is applicable between all elements of all tubes, whether the tubes be of the old type or of the new "metal" types. The "Quality" test on the English-Reading meter scale involves all tube elements, and provisions are incorporated for detecting "open" elements, which is an exclusive feature of this design.

For electrostatic capacitor leakage tests, the tester circuits are resolved into the scheme suggested by Figure 9. The required d.c. potential is supplied by a self-contained rectifier tube. After the initial surge through an "unknown capacitor," there will be no current through the neon lamp unless there be a leaky or short-circuited condition within the unknown capacitor to pass direct current. If the unknown capacitor be short-circuited or if it has very low d.c. resistance, one element of the neon lamp will glow continuously, indicating the presence of a direct current through the unknown capacitor. If the unknown capacitor is not short-circuited, but has a high resistance leakage, the leakage resistance will periodically discharge all accumulated charges of the known capacitor, C, through the neon lamp and the rectifier tube, so that the presence of such a leakage within the unknown

capacitor will be indicated by intermittent glows of one element of the neon lamp.

The condition of the electrolytic capacitor is indicated on a "Good-Bad" scale of one of the meters which is connected into a circuit arrangement indicated in Figure 9. The required d.c. potential is supplied by the self-contained rectifier tube and filter arrangement through the resistance R, which limits the current to a safe value for good capacitors and protects the meter against short-circuited electrolytic capacitors. The scale arrangement of this meter is shown in Figure 11.

The miniature d.c. "power pack" also supplies the power for the two 0/2/20-megohm resistance-measuring ranges which, being an amplification of the conventional arrangement of Figure 12, are not shown in a separate drawing. However, the circuits of the lowest 0/200-ohm range is shown in Figure 13, in which it is observed that the calibration is effected for unknown resistors as shunts. The lowest meter scale division represents 1/4 of 1 ohm, and a half-scale deflection is obtained with a resistance value of only 15 ohms, as shown in Figure 11.

All tubes are tested in five of the tester sockets, without adapters. The other five sockets are used in the analytical functions of the tester. All necessary accessories are supplied with the tester, including complete operating instructions.

R. N. Tenatuner

(Continued from page 15)

medium- and high-impedance inputs. It is not always possible to say in advance which one of these three circuits will work best with any one receiver but an instantaneous change from one circuit to the other is obtainable by means of the circuit selector switch SW2. In using this Trap-Circuit Tenatuner therefore it is only necessary to connect it ahead of your receiver. This is accomplished by connecting your antenna to terminal 1, the antenna binding post of your receiver to terminal 2 and the grounded ground binding post of your receiver to terminal 3. Then when SW2 is set in the "off" position the tuning unit is automatically short-circuited, connecting the antenna direct through to the receiver. In position 1 the tuner functions as circuit (B), in position 2 circuit (C) is in use and in position 3 the circuit becomes the series tuned one shown in (D). A little experimenting with this switch in position 1, 2, and 3 will show which of the three positions is most effective with your particular receiver.

The circuits (E) and (F), Figure 2, are wave-trap circuits. (E) is intended primarily for use in superheterodynes having an intermediate frequency around 465 kc. and is used to eliminate interference picked up at the intermediate frequency. It will also function as a wave trap over a good part of the broadcast-band. If there are powerful local stations toward the high-frequency end of the broadcast-band which cannot be trapped out with circuit (E) then circuit (F) will do the trick because in this circuit the inductance can be reduced by means of tap switch SW1 whereas in circuit (E) the tap switch (SW1) must be set on tap 10 and the entire inductance is therefore in the circuit at all times. In using circuit (F) it is necessary to connect an external jumper between terminals 2 and 4 of the tuning unit. This is the only circuit of the six that requires this special external connection.

While the cost of the parts to build this unit is under \$5.00 (and may be much less, as many builders will have some of the parts on hand) some readers may feel that by first determining which of the three circuits, (B), (C) or (D) work best with their particular receiver, the cost can be further reduced by eliminating switch SW2. This is a logical thought but has the drawback that with some receivers one circuit may work best over part of the broadcast-band and another circuit prove better over the balance of the range. Also, the elimination of this switch would make the wave-trap functions impossible. As the unit now stands it is universal in its application both as an antenna tuner and as a wave trap and it is felt that this greater flexibility certainly justifies the inclusion of this switch.

The switch SW2 employed in the final model is one of the new Yaxley type gang switches. These switches are supplied with the sections widely spaced and with a shaft several inches long. For purposes of compactness this switch was taken apart and the shaft and spacers cut down. If the constructor follows this example he will not find it a difficult task but he must be sure that all parts are reassembled following the original alignment, etc. If one of the old type Yaxley gang switches can be obtained this operation will be unnecessary as this older type was supplied with narrow spaced sections. Or, if the constructor is not particularly interested in compactness the new Yaxley switch can be used without attempting to cut down its size. SW1 of the model unit is one of the old type Yaxley switches which happened to be on hand. Either the new or the old type can be used here.

The coil is home made. It consists of 135 turns, tapped at every 15th turn by twisting a small loop in the winding. The specifications are given in the list of parts. The switch SW1 is

connected so as to short-circuit the unused portion of the coil. Thus, when this switch is set on tap 1 there are only 15 turns in the tuned circuit, 30 turns at tap 2, etc. When set on tap 9 the entire coil is in the circuit—also when set on tap 10. Tap 10 is used only when employing the wave trap circuit (E).

The actual construction of the Trap-Circuit Tenatuner is so simple that the average reader will require no elaboration here. For the inexperienced constructor complete working blueprints are available as mentioned further on. The two sections of the gang condenser are used in parallel. This is accomplished by simply connecting the terminal lugs of the two stators together. It is also advisable to remove the screws from the trimmer condensers on each way out or at least to turn these screws all the way out in order to obtain as low minimum capacity as possible. The binding post which serves as terminal 4 is mounted directly in one of the holes provided in the rear of the condenser frame—or this binding post may be mounted on the front panel if desired and connected to the condenser frame by means of a wire.

List of Parts

- 1 "Trutest" variable condenser, 2 gang, .000365 mid. each section, with 1/4 inch shaft coupling
- 1 Yaxley single-deck 10-point switch (SW1)
- 1 Yaxley 3-deck 6-point switch (SW2)
- 1 Yaxley dial scale, Type 384 (for SW2)
- 1 Yaxley dial scale, Type 380 (for SW1)
- 1 Calibrated dial or calibrated scale and knob (for variable condenser)
- 4 Binding posts
- 1 Bakelite tube 1 3/4 inch outside diameter, 3 3/4 inches long (for coil form)
- 1 Bakelite or wood panel, 5 inches by 7 inches by 3/16 inch
- 1 Baseboard, 5 inches by 6 inches by 3/4 inch
- 1/16 pound No. 28 double silk covered wire
- 3 Right-angle mounting brackets, 1/2 inch (for mounting variable condenser)
- Push back wire, spaghetti tubing, etc.

"BLUEPRINTS"

"Blueprints" of the Trap-circuit Tenatuner, including a full-size picture diagram, have been prepared and may be obtained from RADIO NEWS, Blueprint Department, at 25c the set. These blueprints make the construction so simple that even the veriest novice will have no difficulty in assembling and wiring the parts.

Music from Disks

(Continued from page 8)

the filaments of a series of lamps placed behind small holes and the tones are produced by rotating disks between this light source and a photo-electric cell. The output of the photo-electric cells used for the tones is fed to an amplification system which is capable of high-fidelity response. The employed loudspeakers are capable of handling a wide dynamic and frequency range.

The two manuals of the electronic organ operate the filaments of 900 standard 6-volt lamps. Two banks of stops above the keyboard enable the player to insert harmonics or subharmonics in any predetermined ratio to the fundamental. These stops can also be used for the striking of chords from a single key. It was pointed out by the engineers that the tremelo may be foot or hand-operated. Volume is controlled by a foot pedal.

Compactness was one of the aims of the designers to assure the practicality of moving the photona from studio to studio. It is small enough to pass through an ordinary doorway. It is easily wheeled, and can be placed in working order by simply plugging into a socket of the a.c. lighting lines and connecting the amplifier-speaker unit.

While the photona is generally referred to as a type of "organ," its tones are entirely different than those of any other existing instrument, the designers declare.

SAVE UP TO 50%
DIRECT FROM MIDWEST LABORATORIES

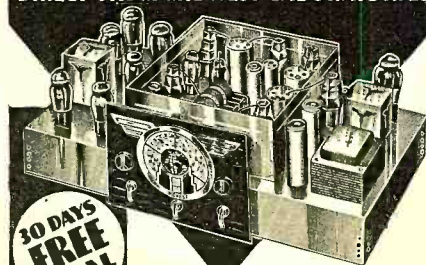

Amazing New **MIDWEST**
HIGHER FIDELITY
16 TUBE (ALL 5 WAVE BANDS)

30 DAYS FREE TRIAL
ONLY RADIO COVERING 9 TO 2,400 METERS.
12,000 MILE TUNING RANGE
5.50 with NEW Deluxe AUDITORIUM-TYPE SPEAKER

FOREIGN RECEPTION Guarantee

ONE YEAR Guarantee

MONEY-BACK Guarantee

TERMS as low as \$5.00 DOWN

EXCLUSIVE features, acting like "Invisible Hands," give magical world-wide High Fidelity reception. Before you buy any radio, write for FREE 36-page 4-color catalog. Learn how thousands saved 1/2 to 1/3 by buying direct from MIDWEST.

This Super De Luxe, 16-tube All-Wave radio gives you: Higher Fidelity reception, 5 wave bands, 50 advanced features, many of them exclusive... such as Multi-Function dial. Only Midwest offers you 9 to 2400 meters. Brings in foreign stations 12,000 miles away.

Hear realistic American and SHORT WAVE programs... Canadian, police, amateur, airplane, ships. One-Year Guarantee, Foreign Reception Guarantee, Money-Back Guarantee. As little as \$5.00 down. 30 days FREE Trial.

Long-Range Radios as Low as... **\$27.50**

MAIL COUPON TODAY FOR FREE MINIATURE CATALOG... FREE 30-DAY TRIAL OFFER... FREE CATALOG

Midwest Radio Corporation
Dept. 254-A CINCINNATI, Ohio

Without obligation send me your FREE catalog, FREE Miniature Dial, and 30-day FREE trial offer. This is NOT an order.

Name.....
Address.....
Town..... State.....

Check here, if interested in Midwest World-Wide Battery Radio.
 Check here, if interested in a Midwest Auto Radio.

IS YOUR CAR A GAS EATER?

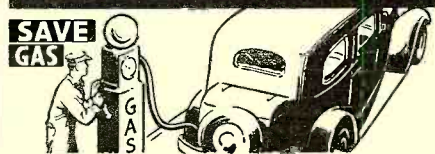

Replace Your Worn Out Auto-Radio Ignition Noise Resistors with New **CONTINENTAL SUPPRESSORS**.

Kit for 6 cyl. Cars.....\$2.70
Kit for 8 cyl. Cars.....\$3.30

Ask Your Auto Radio Serviceman

CONTINENTAL CARBON Inc.
13908 LORAIN, CLEVELAND, OHIO



Mr. E. H. Rietzke, President of CREI, and originator of the first thorough course in Practical Radio Engineering.

CREI TRAINING IS GOOD ENOUGH FOR 170 RADIO STATIONS

It Should Be Proof Enough For You!

... and when we say 170 Stations, that doesn't mean only 170 jobs because some stations employ as many as 5 men. Radio Stations recognize the superiority of men with TECHNICAL TRAINING... and a CREI Diploma has been the 'open sesame' to many good jobs. A course of instruction, constantly revised to meet constantly changing conditions; taught in radio-language to professional radio men who have the ambition to study HARD. It isn't easy, but it is EFFECTIVE!

3 Convenient Study Methods

Complete Home-Study course for men who must be on the job while they learn.

Residence School for those who can spare 9 months for intensive classroom and laboratory work.

Combination Home-Study and Residence Courses, offering 10 weeks of summer training at the Residence School in addition to Home-Study.

FREE!

New 44 Page CATALOGUE

Illustrated Catalogue describing complete facilities, methods of study subjects covered in all courses and easy methods of payment.

Write for your copy, TODAY.



CAPITOL RADIO ENGINEERING INST.
Dept. R. N. 7
14th and Park Road—Washington, D. C.

SERVICE DEALERS!
✓ Check this List ✓



Pick out what you need to bring your equipment up to the minute. You can get all

of these items free with National Union radio tube purchases. Find out how—Check items you want. Paste the list on a penny post card or slip it in an envelope and mail it now!

- HOW CAN I GET:**
- A Tube Tester
 - Service Manuals
 - An All Wave Oscillator
 - A Signal Generator
 - A Multirange Meter
 - A Set Analyzer
 - An Oscillograph
 - A Frequency Modulator
 - A Tube Carrying Case
 - A Coverall Work Coat

Name _____ RN735
Street _____
City _____ State _____

Check—Clip—Mail to
NATIONAL UNION RADIO CORPORATION OF N. Y.
570 Lexington Avenue, New York, N. Y.

German Television

(Continued from page 9)

because of the stations being situated so close to one another. There is also no danger of two stations showing their pictures at the same time to the surprised listener. A great number of these new receivers have to be tuned only once. Later on it is brought into operation by turning only the small switch of the power line.

For the past 9 months, the Berlin Television Station has been radiating interesting programs, daily, on 7 meters. The picture appears, as stated before, behind the surface of a glass plate. Sometimes it is in black and white, but very often, has a slightly bluish or greenish caste. If the transmitter radiates the picture in the so-called "180 lines manner", as is done in Berlin, not only heads, but the entire body may be seen. Entire scenes with all movements are easily recognized.

The average price range of the receivers is from \$250.00 to \$500.00 per set. A television receiver contains two complete receivers, one for sound reception, and the other for the reception and reproduction of the image. While the sound receiver is only connected with the loudspeaker, the picture receiver works with a cathode-ray tube which is the heart of the visual system. Another type of picture receiver uses a "mirror-screw" for reproducing the picture.

Recently, in Germany, there has been developed a television pick-up car. This car carries on its roof a standard motion-picture camera mounted on a cast-iron roof, allowing the camera to be moved in any desired direction. The hollow pillar of the camera support is used to convey the exposed film ribbon to the dark room which is in the interior of the car. By use of special apparatus and extremely fast-working chemicals, the film is developed in 1½ minutes. The still-wet film ribbon is then sent at once through a so-called "Abtastgerät", which cuts the single-film pictures in 180 lines and transforms each line in a succession of strong and weak electrical impulses. The impulses are radiated from a transmitter into the air and the radio listener, receiving these impulses through the televisior, may see the broadcast scenes.

Using Cathode Rays

(Continued from page 35)

rating and about ½ mfd. is connected in series with the vertical deflecting plates to eliminate the d.c. component across the condenser.

The peak magnitude of the voltage across the condenser can then be noted and assurance obtained that the peak voltage does not bring the operation above the safe rating of the filter condenser.

A peculiar and often puzzling characteristic of push-pull stages can be pictured with cathode-ray equipment. Often, a push-pull amplifier which shows very little hum without signal will produce considerable hum when excited. If this excitation is music or speech, the existence of hum is too variable to be identified as such, but may in many instances be sufficiently high to cause "hash" in the reproduction.

This signal or modulation type hum can be investigated with a harmonic or a linear sweep circuit, but in either case an oscillator of some frequency other than 60 cycles must be used for the driver sig-

nal. It should preferably be in the neighborhood of 1000 cycles.

The control circuit of the linear sweep must be connected to the power line and the sweep rate adjusted to either 60 or 30 times per second. If unbalance or signal hum is present, a trace such as Pattern 22 will result. (It is interesting to note the similarity between this pattern and some of the modulation patterns which follow in next month's discussion.)

The solidity of the pattern is due to the "filling-in" effect of the high signal frequency employed, while the depth of the "hum envelope" indicates the degree of unbalance hum which is present. Hum of this character is invariably found in amplifier designs where it is necessary to carefully select push-pull tubes by pairs in order to reduce the hum under the no-signal condition. Careful selection of the tubes simply causes the hum to balance out when no signal is applied, but it is periodically introduced as "hash" when a signal is applied.

In the absence of a linear sweep, the harmonic sweep may be employed using a high-frequency signal voltage. Pattern 24 will result if signal hum is present.

Make a Pantograph

(Continued from page 10)

place where the letter is to be engraved. The master letter is now placed under the stylus and adjusted so that the base of the master letter is parallel to the baseline on which the engraved letter will appear. The stylus is now lowered until it is close to but not touching the master letter, and the set-screw tightened. No adjustment of the stylus should be made, once the process of engraving is started, until the letter is completed. Next, grasp the end of the arm into which the stylus is screwed and, slowly but steadily, draw the stylus along the lines of the master-letter. Trace the master-letter over and over again until the engraving is of the required depth. The weight of the device exerts sufficient pressure; no additional pressure is necessary.

After the letter is engraved the slight burr left by the cutter along the edges of the letter, should be removed. A good tool for this work is a small triangular file which has one end broken off. The re-touching is performed with the sharp point.

A Correction

In the article on a "Thermionic Voltmeter," by William R. Harry, on page 665

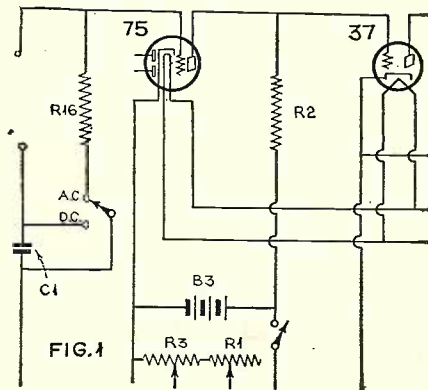

of the May issue, the following corrections should be made:

In Figure 1, the connections to the a.c.-d.c. switch from C1 and R16 should be changed to the hook-up shown here. In

"Bruno" The SYMBOL of QUALITY
NEW and IMPROVED

GUARANTEED HIGH FIDELITY VELOCITY MIKE!

Employing the principle of velocity of the sound wave, a naturalness of tone that was unattainable heretofore, has been achieved.

A quality "mike" remarkably low priced. Get your information on this latest development today!



BRUNO Laboratories
20-22 WEST 22nd ST.
New York, N. Y.

Read Classified Advertising—It Pays

Advertisements in this section twenty cents a word for each insertion. Name and address must be included at the above rate. Cash should accompany all classified advertisements unless placed by an accredited advertising agency. No advertisements for less than 10 words accepted. Objectionable or misleading advertisements not accepted. Advertisements for these columns should reach us not later than 3rd of 2nd month preceding issue.

TECK PUBLICATIONS, INC.
461 Eighth Ave. New York, N. Y.

A.C. Auto Generators

TWENTY new practical changes for automobile generators. See our advertisement at bottom of page 51. Auto Power, Inc.

Agents Wanted

AGENTS: Stick-on-Window Sign Letters. 500% profit. Write today. Metallic Letter Co., 422 N. Clark, Chicago.

Automobiles

200 MILES 35c Semi Diesel. Install yourself, parts under \$5.00. Blueprint instructions 50c. Cecil Carmichael, 5013 2nd Ave., Los Angeles, Cal.

Correspondence Courses

USED Correspondence Courses and Educational Books sold or rented. Inexpensive. Money-back guarantee. Write for Free Catalog listing 4000 bargains. (Courses bought.) Lee Mountain, Pisgah, Alabama.

Electrical Supplies

INSULATION, wire, varnishes, supplies, etc. Send 3c stamp for bulletin. Auto Power, 414-A S. Hoyle Ave., Chicago.

Patent Attorneys

PATENTS. Instruction "How to Establish Your Rights" and form. "Evidence of Conception"—sent Free! Lancaster, Allwine & Rommel, 414 Bowen Building, Washington, D. C.

PATENTS—Advice and booklet free. Highest references. Best results. Promptness assured. Watson E. Coleman, Patent Lawyer, 724 9th Street, Washington, D. C.

Patents and Inventions

INVENTIONS COMMERCIALIZED. Patented or unpatented. Write Adam Fisher Company, 278 Enright, St. Louis, Missouri.

Photo Finishing

TWO PROFESSIONAL double weight enlargements and eight guaranteed prints, 25c. Mays Photo Shop, LaCrosse, Wis.

EIGHT GUARANTEED prints and two professional double weight enlargements, 25c. Perfect Film Service, LaCrosse, Wis.

Radio

RADIO ENGINEERING, broadcasting, aviation and police radio, servicing, marine and Morse telegraphy taught thoroughly. All expenses low. Catalog free. Dodge's Institute, Elm St., Valparaiso, Ind.

Song Poems Wanted

SONG POEMS Wanted. Free examination, 50-50 plan. Song Bureau, Salem, Indiana.

Wind Driven Lights

ELECTRIC LIGHTS—WIND DRIVEN—You build them. Write, Wind Motor Electric, Ridgway, Montana.

Figure 2, an added connection has to be made from the position terminals of B7,

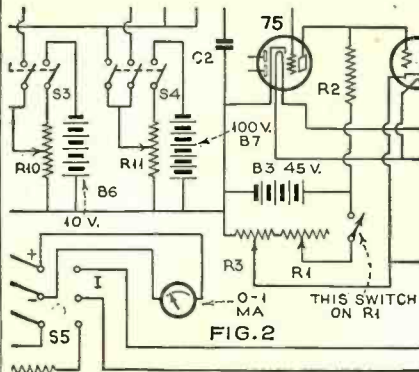

B6, B5 to the negative terminal of B3. This is also shown herewith. Without this connection the grid is floating and the instrument is inoperative.

The Service Bench

(Continued from page 43)

The customer merely points to what he wants, like most folks ordering from a French menu, and the item is taken from

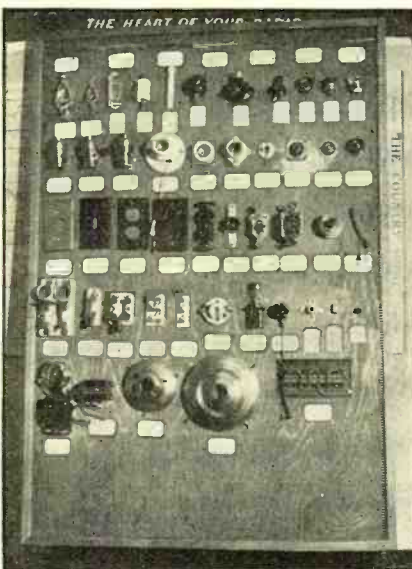

FIGURE 3

stock. The tag below each part gives its correct name, the list price and the cost to the store in code.

HELPFUL SERVICE NOTES ON RUNNING YOUR BUSINESS

The growing interest in the possibilities of the cathode-ray oscillograph for radio service work is manifest from many sources. The John F. Rider organization has been active in this field for many years, and the results of extensive experimentation, particularly from the service angle, have just been published in book form.

Attention is also being given to this method of expediting service work in the Sprayberry course. Mr. Sprayberry observes—"Up to now it has not been possible to determine the individual characteristics of a tuned r.f. or i.f. stage. All that could be done was to connect your output-meter to one or more stages and adjust the trimmers for maximum scale deflection. This did not tell you if one stage was over-coupled, had 'double

Interested in
SHORT WAVE?
Then you need this

FREE SHORT WAVE MANUAL

Here between the covers of this 32-page book you will find the complete descriptions of all that is best in short wave receiver design. Thirteen sets are fully described and illustrated—everyone a top notcher—the "cream" of the 1935 crop!

Over 70 illustrations and diagrams make it an outstanding book which anyone needs who wishes to construct a simple yet efficient set for S.W. reception!



Here at SHORT WAVE HEADQUARTERS, where we collaborate with every leading manufacturer, we can supply you with any standard parts for any kit described in the Hammarlund Short Wave Manual, Popular Mechanics, Radio Craft, Short Wave Craft, Radio News and many others.

Consult us before you build! **SAVE MONEY** by buying from us at lowest **WHOLESALE** prices!

"BROWNING 35"

The most outstanding All-Wave Super-Het of 1935! Assures you round the world reception with the clarity and strength of locals! Designed for the S.W. Listening Post Observer who appreciates actually getting high signal to noise ratio! Acclaimed by practically every leading Radio Engineer, Editor and Publication in the industry. **FREE!** Big illustrated tabloid with full description, circuit diagrams, parts list, etc. Get your Kit from us at **LOWEST WHOLESALE PRICES.**

WHOLESALE RADIO SERVICE

Main Office and Warehouse: 100 SIXTH AVENUE - NEW YORK, N.Y.

Branches: ATLANTA, GA. 426 W. Peachtree St. N.W. NEWARK, N.J. 319 Central Ave.

Wholesale Radio Service Co., 100 Sixth Ave., Dept. N-75, New York, N. Y.

Send me your FREE S. W. Kit Manual for 1935.

Send me FREE tabloid on the Browning "35."

Name.....

Address.....

City..... State.....

BIRNBACH
AUTO Antenna KIT
Ideal for TURRET-TOP CARS

With Shielded Lead-in, List \$2.25
With Lacquered Lead-in, List \$1.90

Clear, strong signals with less noise. Unaffected by steel shielding; away from mud thrown by wheels. Write Dept. RN-7 for complete data.

BIRNBACH RADIO CO., Inc.
145 Hudson Street New York City

SOLAR Auto Radio **CONDENSERS**

Always reliable; meet the most exacting requirements of radio use. Fully withstand unusual conditions of heat and vibration. Complete line of standard and special types.

- ★ OIL-IMPREGNATED VIBRATOR CONDENSERS
- ★ SUPPRESSOR CONDENSERS
- ★ DOME LIGHT FILTERS

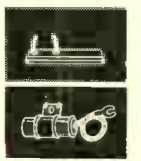

SOLAR MANUFACTURING CORP.
599-601 Broadway New York, U. S. A.

ONE INSTRUMENT FOR ALL TESTS

SHALLCROSS UNIVERSAL TESTER

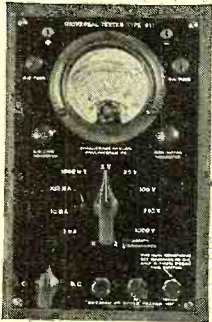

Volts A.C.-D.C. 5-25-100-250-1000
1000 ohms per volt

Milliamperes D.C. 1-10-100-1000

Capacity .001-10 Mfd.
Paper or electrolytic condensers

Inductance 1-10,000 Henrys

D. C. Resistance .5-5,000,000 ohms

Send 6c in stamps for new Bulletin No. 611-DA containing the complete wiring diagram and operating instructions for this modern serviceman's instrument.

SHALLCROSS MFG. COMPANY
Electrical Measuring Instruments and Accurate Resistors
700 MAC DADE BOULEVARD
COLLINGDALE, PA.



SOMETHING DIFFERENT!

In the Ross line of radio receivers you will find units scientifically designed for **THOSE WHO DEMAND THE FINEST RADIO PERFORMANCE.** Years of experience in the production of both standard and custom-built sets enable us to offer unusual values that will amaze you by their truly outstanding qualities. Used by leading amateurs and professionals throughout the world. Write for catalog.

A. H. ROSS & CO.
Keswick Ave. & Waverly Road
Glenside, Pa.

\$25 AND UP

CORNICO
"NOISE-MASTER"
ANTENNA

For clear, pure, NATURAL reception on both broadcast and shortwave bands. No more "man-made" static! Service men. INVESTIGATE!

CORNISH WIRE CO., Inc.
30 Church Street
New York City

humps' or was oscillating. The cathode-ray tube now comes to your rescue, and for the first time you can duplicate the adjustments that the factory and laboratories are able to apply to a receiver."

The mail-order houses have been quick to anticipate the need for cathode-ray oscillographs. In the booth shown in Figure 4—an exhibit in the recent I. R. S. M. radio service convention and show in Chicago—the display to the left center shows how the cathode-ray tube is employed in fast, accurate servicing.

A New Fast-selling and Popular Sideline

The illustration of Figure 5 shows a handsome substitute for the usual door bell, which any serviceman can install in short order and with a generous profit. It

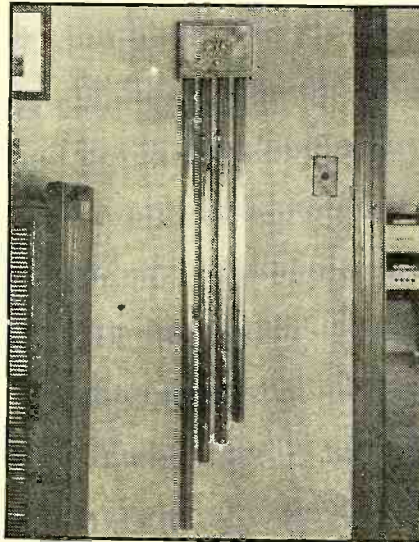

FIGURE 5

is as easy on the ears as on the eyes. The device is a chimes that plays the eight notes of the standard chime sequence to the tune of "How Dry I Am," when anyone touches the door button. It is then up to the host to do his stuff. The mechanism is not at all complicated, and

READ SEND CODE Like an Expert

Learn Quickly at Home—Get Real SPEED

It's easy, fascinating, to become a good op with the New MASTER TELEPLEX Code Teacher to help you. Only instrument ever produced which records your sending in visible dots and dashes on copper tapes then sends back to you. Also sends practice work, recorded by an expert, at any speed you want. Thousands agree this method is surest, quickest—has taught more ops in past few years than all other methods combined. Used by U. S. Army, Navy, A. T. & T., R. C. A., and others. We furnish Complete Course, lend you Master Teleplex, give you personal instruction with a MONEY-BACK GUARANTEE. Low cost. Send today for booklet RN 31; no obligation; post card will do.

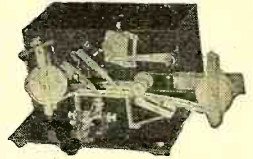

FREE BOOK
TELEPLEX COMPANY
76 Cortlandt St., New York, N.Y.
MASTER TELEPLEX—"The Choice of Those Who Know"

We SPECIALIZE in the Design and Manufacture of Public Address Amplifiers
SEND FOR FREE CATALOG!
Number K-30

Describes in detail 86 different models and complete P.A. Systems ranging up to 200 audio watts output. 6 volt; AC; DC.

Buy Direct from Manufacturer AND SAVE BIG MONEY
Coast to Coast Radio Corp.
559-N Sixth Ave., New York, N. Y.

ENGINEERING DEGREE IN TWO YEARS

B.S. Degree in Radio, Electrical, Civil, Chemical, Mechanical or Aeronautical Engineering in two years. Located in an industrial center with that Engineering atmosphere. Earn board. Low tuition. Preparatory Department. Enter June, September, December, March. Catalog.

INDIANA TECHNICAL COLLEGE
241 E. Washington St., Fort Wayne, Ind.

Ken-Rad Radio Tubes
DEPENDABLE LONG LIFE

THE KEN-RAD CORP., Inc., Owensboro, Ky.

INDEX OF ADVERTISERS

Aerovox Corp.	52	National Company, Inc.	49
Alhambra Chime Works	64	National Radio Inst.	Third Cover
Allied Radio Corp.	48, 58	National Schools	44
American Transformer Co.	42	National Union Radio Corp.	60
Amperite Corp.	64	RCA Institutes, Inc.	50
AutoPower, Inc.	51	RCA Manufacturing Co.	58
Birnback Radio Co., Inc.	61	Radio Circular Co., Inc.	64
Bruno Laboratories	61	Radio City Products Co.	58
Candler System Co., The	64	Radio & Technical Publishing Co.	63
Capitol Radio Engineering Inst.	60	Radio Trading Co.	63
Central Radio Laboratories	44	Radolek Co., The	63
Chicago Radio Apparatus Co.	63	Radio Training Association of America	48
Classified Advertisements	61	Raytheon Production Corp.	56
Coast-to-Coast Radio Corp.	62	Readrite Meter Works	53
Continental Carbon, Inc.	59	Rider, John F.	50
Cornish Wire Co., Inc.	62	Rim Radio Mfg. Co.	46
Coyne Electrical School	46, 63	Ross & Co., A. H.	62
Deutschmann Corp., Tobe	57	Scott Radio Labs., Inc., E. H.	39
Dodges Institute	54	Shallcross Mfg. Co.	62
Eagle Radio	64	Silver, Inc., McMurdo	52
Electrad, Inc.	42	Solar Mfg. Corp.	61
Electronic Laboratories, Inc.	57	Sprayberry, F. L.	64
Experimental Radio Labs.	51	Supreme Instruments Corp.	Second Cover
General Electric Co.	41	Teleplex Co.	62
Hallcrafters, Inc.	51	Thor Radio Corp.	64
Hammarlund Mfg. Co.	41	Toledo Sound Equipment Laboratories	56
Hygrade-Sylvania Corp.	47	Trim Radio Mfg. Co.	53
Indiana Technical College	62	Triplett Electrical Instrument Co.	43
Instructograph Co.	51	Tri-State College	64
Justrite Mfg. Co.	44	Try-Mo Radio Co., Inc.	44
Ken-Rad Corporation, Inc., The	62	Tung-Sol Radio Tubes, Inc.	45
Kenyon Transformer Co., Inc.	41	United Sound Engineering Co.	46
Littelfuse Labs.	48	Universal Microphone Co., Ltd.	63
McGraw-Hill Book Co., Inc.	54	University of Wisconsin	64
Mallory & Co., Inc., P. R.	Fourth Cover	Webster Co., The	51
Midwest Radio Corp.	59	Weston Electrical Instruments Corp.	55
Muter Company, The	63	Wholesale Radio Service Co.	61
		Wright-DeCoster, Inc.	54

AUTO RADIO

116 pages and 68 illustrations give you complete dope on installing and servicing auto radio—most up-to-date methods—ignition wiring diagrams for cars—most comprehensive treatment in any text-book. That's just one chapter in Ghirardi's new 1800-page—

MODERN RADIO SERVICING

Radio & Technical Publishing Co.
45 Astor Place, New York, Dept. RN-7

Send for **FREE** circular



free!

100% SHORT-WAVES

52 Pages—50 Hookups
ALL ABOUT: Xmitting and Receiving Antennas—Bandspreading. Receiving Foreign Stations. Xmitting tubes. HOW TO BUILD "19" Twinplex. 5 and 10 Meter Xmitter. "203-A" Xmitter. Bandspread Doublet Set. How To Get Started in Short Waves, etc., etc. Send postcard with name and address. Treatise sent by return mail.

RADIO TRADING CO. 95 Hudson St. New York City

HAMS & S.W. FANS TRADE WITH CHIRAD

We will consider in trade your old receiver, if standard make, on a new crystal controlled.

Super SKY-RIDER

Get in touch with CHIRAD first. Let us make you an offer. Budget Payments if desired.

CHICAGO RADIO APPARATUS CO.
415 S. Dearborn St., Dept. RN-11, Chicago, Ill.

LEARN IN 12 WEEKS IN COYNE SHOPS ELECTRICITY

LEARN BY DOING—Actual work on real Electrical machinery—No Books, Classes, or Correspondence. Prepare for a real job—Earn As You Learn.

I'LL FINANCE YOUR TRAINING
Borrow tuition from me, pay me back in small monthly payments. Electric Refrigeration and Air Conditioning Course included at no extra cost. Write for details and "Pay Tuition-After-Graduation" Plan.

H. C. LEWIS, Pres. Coyne Electrical School
500 S. Paulina St., Dept. BS-89, Chicago, Ill.



Universal Model "W"

The perfected Watch Model Microphone—Completely protected—Light—Compact—Very sensitive—Full quality performance.

UNIVERSAL MICROPHONE CO., Ltd.
424 Warren Lane, Inglewood, Calif., U.S.A.

The 1935 Radio Man's Guide FREE!

with 5 issues Radio News at \$1

You'll be amazed at the large amount of valuable data in the 64-page 1935 RADIO MAN'S GUIDE! Covers set building, servicing and laboratory instruments, radio trouble shooting, DX aids, "Ham" notes, public address systems, experimental radio data and charts and station lists. Get your free copy of this 7½" by 11" book by subscribing for RADIO NEWS today. You get 5 issues for only \$1. (Canada \$1.25—Foreign \$1.50.)

Dept. 357

Radio News

461 8th Avenue New York, N. Y.

the novelty is appealing to many customers who are not sold on the esthetic superiority alone. Full details can be secured by writing to Alhambra Chime Works, 1117 South Monterey Street, Alhambra, California.

THE DAY'S WORK AT THE SERVICE BENCH

Russell Woolley, of Seattle, Washington, sends through the following notes: "Philco, Model A, Auto Receiver—When the usual B-eliminator is employed to supply power to this set, the grounded negative terminal must be disconnected from the case of the eliminator; otherwise the C bias to the 71 power tubes is short-circuited out. As may be observed in the Philco manual, the mid-tap of the audio input transformer is connected directly to the negative battery lead and grounded through a resistor. An A choke may also be necessary to filter out the vibrator hum, which feeds through the hot filament circuit.

"Universal Model 42—Many of these sets have come in with short-circuited filter condensers; usually the 4 mfd. section. It is a trick filter circuit and the only way you can repair the set (without melting the block) is to cut the black wire which is grounded to the chassis. This wire is not, as might be thought, the common ground of the entire block, but only the ground of the 4 mfd. section. A mixed-color wire grounds the other sections. The replacement is connected between the ground and the brown lead, which is common to various other condensers and also the r.f. plate coils. You will find the circuit listed under receivers made by the Transformer Company of America in the well-known manuals."

A Third Hand for Rewinding Drum Dials

Mr. V. V. Gunsolley, of the General Radio Service, Minneapolis, Minn., finds a new use for the always handy roll of adhesive tape—"For the benefit of the boys having trouble with dial-cable replacements: Take one or two wraps of tape around the shaft in the correct direction, and plaster the free end against the chassis. This will take up the winding torque of the cable around the threaded bobbin. When the bobbin is wound to the desired amount, take another piece of adhesive tape and make two wraps around the bobbin—cable and all—and stick the free end to the chassis. If trouble is experienced in keeping the cable on the guide pulleys, tape will do the trick here, too. However, I find the little rubber wedges, sold at the "five-and-tens" for window and door stops, are just the thing to wedge between pulley and chassis for this purpose. In some receivers, they can be used to keep the cable in place after winding, and thus save tape."

While on the subject of "third" hands, A. W. Tytler, Jr., and L. L. Hotsenpiller, of the Roanoke Radio Service, Kansas City, Mo., suggest the following—"While a pair of long-nose pliers is very useful, in many instances it is difficult to maintain pressure on them in tight corners. In close quarters, and for starting screws, nuts, etc., a pair of valve-key pliers is very handy. They have a spring tension that keeps them clamped on the screw or other small article. With the help of two pair, volume controls and similar parts can be readily mounted, bolts can be held in place far down in the chassis and small objects can be picked up where the fingers could never reach them. These pliers only cost about ten cents in most auto supply houses."

Messrs. Tytler and Hotsenpiller special-



I comb the racket from the waves When I say "don't" It sure behaves . . .

ONLY \$1

Any antenna but a doublet is obsolete—and any doublet without "Little Ajax" is just another aerial! It is a true ALL-WAVE Tuning Coupler that goes between your set and your doublet. It has a switch with three taps to adjust the aerial for QUIET European reception, efficient broadcast reception, or the sharpest possible tuning on any band. Beside that "Little Ajax" is a remarkably efficient noise eliminator.

Get one from your jobber—or mail coupon NOW for one. postage paid. Pay the postman \$1.00.

MAIL THIS COUPON!

THE MUTER COMPANY
1255H South Michigan Ave. Chicago, Illinois

Please RUSH me one of your All-Wave Tuning Couplers. I will pay the postman \$1.00. It must satisfy me in every way.

Name

Address



New! RADOLEK AMPLIFIERS and "P.A." SYSTEMS

Fifteen powerful, compact, single unit amplifiers—at the right price and for every purpose. From 4 watts to 60 watts! Up-to-the-minute. Newest features—Tone Controls, Built-in Mixing Systems, Plug-in input and outputs. Complete systems for any job. Easy fast installation, you merely plug the units together.

FREE

New 48 page book completely describing the entire line as well as information on Sound Trucks, Installations for the Hard of Hearing, Call Systems, etc.



The RADOLEK Co.
601 W. Randolph St., Chicago
Send me FREE "P.A." Book.

Name

Address

New 7-POINT MIKE
ACHIEVES
GREATER VOLUME
and PERFECT
REPRODUCTION
WITHOUT FEEDBACK

The Ideal microphone brought within your reach . . . and guaranteed to be the finest value in mikes, regardless of price, or your money back! For the first time in America the new Super-flux Nickel Aluminum Magnets are used . . . magnets more powerful than even 36% Cobalt. You get 8 times more volume without feedback than you can get with diaphragm type mike. Completely free from distortion, peaks, or hum pickup. Rugged. Fitted with swivel bracket. Two Models: RB-S, especially designed for speech; output, -68 db. RB-M, recommended for speech and music; output, -64 db.

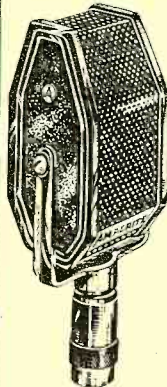

A. C. PREAMPLIFIER
Thoroughly shielded and guaranteed humless. 30-14,000 cycles (1 db.). Hum level, -100 db.
Write for Illustrated Bulletin RN-6
AMPERITE Corporation
501 BROADWAY NEW YORK

AMPERITE 7-POINT
velocity **MICROPHONE**

R G H
5
ALL WAVE
AC
Self Powered

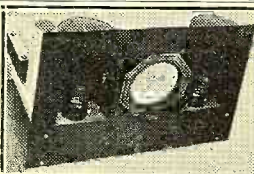

Uses 2/58, 2/2a5, 1/80 tubes. Highly sensitive regenerative all wave kit ready mounted on specially constructed chassis and panel with gothic recesses for easy changing of coils.

Loud speaker volume assured. Complete kit of parts including 8 S.W. coils.

Dynamic Speaker **\$12.95**
\$2.50 extra

4 Broadcast coils—\$1.80

Send for FREE Data—Mail Orders Filled



167 GREENWICH ST., NEW YORK CITY

OSCILLOGRAPH!

Here at last is a publication consisting of 4 complete, easily understood, illustrated lessons telling you ALL about the CATHODE RAY TUBE OSCILLOGRAPH—Where it can be used—exactly HOW to use it in EVERY radio service application. Hundreds already sold to servicemen who recognize the tremendous importance of the oscillograph. Get yours today. Send check or money order or write for FREE details. Address: F. L. Sprayberry, 2548 University Place, N. W., Washington, D. C. **ONLY \$2** While the Edition Lasts

"TESTING RECEIVERS"

SPRAYBERRY

WITH THE OSCILLOGRAPH"

ize in auto-radio installation and servicing. The following observation and recommendation are based on their experiences—"So many cases of auto-radio trouble are due to power-supply complications that special equipment for simplifying the detection of such faults is justified. Usually the connections from the vibrator to the tubes are rather out-of-the-way and hard to locate. If one knew that the remainder of the radio were okay, the trouble would be localized in the power supply. To expedite the localization of trouble, we have found it convenient to have a power supply coming out through binding-posts on the Service Bench. This gives us 200 volts d.c. that can be applied directly to the set. Also, two posts on the bench are wired to the power supply after the current is rectified, but before it is filtered, enabling us to input pulsating d.c. to the filter system of the car radio, thus facilitating the determination of whether the trouble is in the filter or rectification circuits."

What's New in Radio

(Continued from page 47)

tenna is provided, and no ground connection is required. The tuning range is from 540 to 1750 kc., with an extra police range between 2000 and 2600 kc. The circuit has automatic volume control.

A Portable Set for Vacationing

This compact Philco receiver model 548 made to operate from either a. c. or d. c. current has automatic volume control and



a pentode audio amplifying system. It is a dual-range set covering the police and amateur signals in addition to the regular broadcast programs.

A New Line of Speakers

The Sonochorde Sales Company announces a complete new line of high-fidelity, electro-dynamic type speakers, comprising 4 different sizes—5, 6, 8 and 11 inch—and also 2 automobile speakers. Through a wide variety of field and input transformer values, 741 combinations are available for general replacement use. The manufacturer calls attention to a unique method of assembly which enables an unskilled person to take the speaker apart and reassemble it with proper pole-clearances.

An A. C. Operated Portable Phonograph

This compact Operadio model A725 phonograph unit is equipped with a new design synchronous two-speed self-starting motor, permitting the playing of either the 33 1/3 or 78 r.p.m. records of either the 10, 12, or 16 inch size. It incorporates a volume control as well as a tone control. Models are available with either the crystal or the electro-magnetic type pick-up.

TRI-STATE COLLEGE

DEGREE IN 2 YEARS

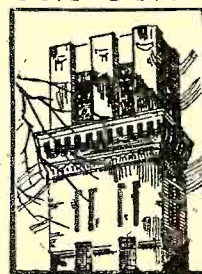

Radio Engineering

Complete Radio Engineering course in 96 weeks. Bachelor of Science Degree. Radio (television, talking pictures and the vast electronic field) offers unusual opportunities for trained radio engineers. Courses also in Civil, Electrical, Mechanical, Chemical, Aeronautical Engineering; Business Administration and Accounting. Low tuition, low living costs. World famous for technical two-year courses. Those who lack high school may make up work. Students from all parts of the world. 52nd year. Located in picturesque hill and lake region of northern Indiana. Enter September, January, March and June. Write for catalog. 1675 College Ave., Angola, Ind.

SEND FOR THIS
FREE
CATALOG
Chock full of BARGAINS in RADIO SETS, Long and Short Wave Apparatus, Servicemen's Repair and Replacement Parts, Electrical Appliances and hundreds of miscellaneous Specials at TREMENDOUS SAVINGS. Get this big new Bargain Book. It's absolutely FREE without obligation—just send us your Name and Address on a post card.
RADIO CIRCULAR CO., INC.
225 Varick St., Dept. R. N., New York, N. Y.

LEARN CODE
Be a REAL radio operator. Make money with radio. Get your AMATEUR or COMMERCIAL TICKET. Ted McElroy on March 11 at Chatham, Mass., officially copied 77 words per minute, Continental Code—breaking all records. He's a Candler man! Stop copying letter by letter—make code a language. Have Candler train you by the methods he used in training ALL the Champion radio operators.
Write for your FREE copy of "BOOK of FACTS for RADIO OPERATORS."
FREE
CANDLER
6343 S. KEDZIE AVE. Dept. CHICAGO

University Course in
RADIO COMMUNICATION
Open to high school graduates. Complete in nine months. High standard of instruction and equipment. Fall term opens September 19.
UNIVERSITY OF WISCONSIN—Extension Division
623 West State Street Milwaukee, Wisconsin

Demonstrating the Power of a Penny!
Just write your name and address on a postcard and receive—
1c **4** **VALUABLE CIRCUITS FREE**
1. Leonard Victor E. C. Four
2. Marlan Playboy "G" all-wave
3. Eagle "7" all-wave super
4. Quadrayne 2-tube A.C.-D.C.
EAGLE RADIO, 84 Cortlandt St., N. Y. City

BUILD AND SELL
DOOR BELL CHIMES
Develop new sales—new revenue—Replace nerve-racking door bells with beautiful 8 note Westminster Chimes. Mechanism supplied ready to install, less brass chimes and cover . . . \$ 0
Send today for FREE descriptive circular—a natural for radio dealers. **ALHAMBRA CHIME WORKS, Alhambra, Calif.**



J. E. Smith,
President
National Radio
Institute

I WILL HELP YOU START A SPARE TIME OR FULL TIME RADIO SERVICE BUSINESS WITHOUT CAPITAL

HERE ARE A FEW EXAMPLES
OF THE KIND OF MONEY
I TRAIN MY MEN TO MAKE

Clears \$4500 in 18 Months

"Before taking your Radio Course I was making \$18 a week. I came here three years ago. In about 18 months I made about \$4500 in Radio. I cannot say too much for the wonderful help I have received from N. R. I."

Noel W. Ray,
619 Broad St.,
Gadsden, Alabama.



Spare Time Work Pays \$18 a Week

"I only do spare time Radio work and average \$18 a week. People who in good times would buy a new Radio, now have the old one fixed."

Stephen J. Drapachy,
407 Wunderlich Avenue,
Barberton, Ohio.



Now Owns Own Business

"If I had not taken your Course I would be digging ditches instead of running my own business. One week I made \$75 on repairing alone, and this doesn't count sales. If a fellow wants to get into Radio, N. R. I. is the starting point."

R. S. Lewis,
Modern Radio Service,
Pittsfield, Ill.



You Get PRACTICAL EXPERIENCE with Radio Equipment I Give You

My Course is not all theory. I'll show you how to use my special Radio equipment for conducting experiments and building circuits which illustrate important principles used in such well-known sets as Westinghouse, General Electric, Philco, R.C.A., Victor, Majestic, and others. You work out with your own hands many of the things you read in our lesson books. This 50-50 method of training makes learning at home easy, interesting, fascinating, intensely practical. You learn how sets work, why they work, how to make them work.



Free Book Tells How Mail Coupon!

The world-wide use of Radio sets for home entertainment has made many opportunities for you to have a spare time or full time Radio business of your own. The day you enroll I start sending you Extra Money Job Sheets which quickly show you how to do Radio repair jobs common in most every neighborhood. Many N. R. I. men make \$5, \$10, \$15 a week extra in spare time while learning. I show you how to install and service all types of receiving sets. I give you Radio equipment and instructions for conducting experiments, for building circuits and testing equipment, and for making tests that will give you broad, practical Radio experience. Clip the coupon below and get my free 64-page book, "Rich Rewards in Radio"—it gives you a full story of the success of N. R. I. students and graduates, and tells how to start a spare time or full time Radio business on money made in spare time while learning.

Many N. R. I. Men Make \$5, \$10, \$15 a Week Extra in Spare Time While Learning

Many of the seventeen million sets now in use are less than 50% efficient. I will show you how to cash in on this condition. I will show you the plans and ideas that have enabled many others to make \$5, \$10, \$15 a week in spare time while learning. Ford R. Leary, 1633 Davison Road, Flint, Mich., wrote: "My part time earnings while taking the N. R. I. Course were \$651."

Get Ready Now for a Radio Business of Your Own and for Jobs Like These

Broadcasting stations use engineers, operators, station managers, and pay up to \$5,000 a year. Radio manufacturers use testers, inspectors, foremen, engineers, servicemen and buyers, and pay up to \$6,000 a year. Radio dealers and jobbers employ hundreds of servicemen, salesmen, managers, and pay up to \$5,000 a year. Radio operators on ships enjoy life, see

the world, with board and lodging free, and get good pay besides. My book tells you of the opportunities in these fields, also in Aviation Radio, Television, Police Radio, Short Wave Radio, Automobile Radio and other new branches of this fast growing industry. Get it.

I Train You at Home in Your Spare Time

Hold your job until you're ready for another. Give me only part of your spare time. You do not need a high school or college education. Hundreds with only a common school education have won bigger pay through N. R. I. J. A. Vaughn jumped from \$35 to \$100 a week. J. E. McLaurine increased his earnings 100 per cent. The National Radio Institute is the Pioneer and World's Largest organization devoted exclusively to training men and young men by Home Study for good jobs in the Radio industry.

You Must Be Satisfied

I will give you an agreement to refund every penny of your money if you are not satisfied with my Lesson and Instruction Service when you complete my Training. And I'll not only give you thorough training in Radio principles, practical experience in building and servicing sets, but also Advanced Specialized Training in the type of Radio work you choose.

Get My Free Book of Facts

Mail the coupon for "Rich Rewards in Radio." It's free to any ambitious fellow over 15 years old. It tells you about Radio's spare time and full time opportunities; about my training; what others who have taken it are doing and making. Mail coupon now in an envelope, or paste it on a 1c post card.

J. E. SMITH, Pres.
Dept. 5GR
National Radio
Institute,
Washington, D. C.

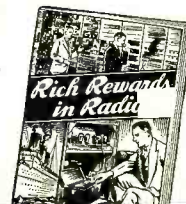

FREE LESSON

On Radio Set Servicing and Rebuilding

I'LL PROVE my Course is WHAT YOU NEED to master Radio. Send coupon for FREE lesson. "Direct Stage by Stage elimination method of Trouble Shooting." This interesting lesson shows many ways to correct every-day Radio troubles. Get acquainted with N.R.I. Training. See how well the lessons are written—how PRACTICAL they are. You'll quickly see why so many of my students have become Radio Experts and now earn two or three times their former pay. See for yourself. Get the sample lesson FREE.

MAIL COUPON NOW

This Coupon is Good For One FREE COPY OF MY NEW BOOK

J. E. SMITH, President,
National Radio Institute,
Dept. 5GR,
Washington, D. C.



Dear Mr. Smith: Without obligation, send me the Sample Lesson and your free book about spare time and full time Radio opportunities, and how I can train for them at home in spare time. (Please print plainly.)

Name Age.....

Address

City State.... "39"

Find out about the World Famous Course that Pays for Itself

Do You Know This?



There is a Mallory Replacement Vibrator Available for Every Radio Set!

At No Greater Cost than Ordinary Vibrators

Service Men now may replace with Mallory Vibrators—the standard of the industry—no matter what the make or model of the auto radio set.

That means better service—greater profit—more satisfied customers—more time saved and a better reputation for the man who does the job. It makes it possible to really build business at the time when the demand for effective service on auto radio sets is growing by leaps and bounds.

Over half of the auto radio sets now in operation are equipped with vibrators made by Mallory. Mallory is the leader—the pioneer in new developments—and Mallory now gives you service such as you never have had before.

Order Mallory Replacement Vibrators from your jobber—Today!



P. R. MALLORY & CO., Inc.
INDIANAPOLIS INDIANA